



HAL
open science

From Vinylidene Fluoride (VDF) to the Applications of VDF-Containing Polymers and Copolymers: Recent Developments and Future Trends

B. Ameduri

► **To cite this version:**

B. Ameduri. From Vinylidene Fluoride (VDF) to the Applications of VDF-Containing Polymers and Copolymers: Recent Developments and Future Trends. *Chemical Reviews*, 2009, 109, pp.6632-6686. 10.1021/cr800187m . hal-00447403

HAL Id: hal-00447403

<https://hal.science/hal-00447403>

Submitted on 14 Jan 2010

HAL is a multi-disciplinary open access archive for the deposit and dissemination of scientific research documents, whether they are published or not. The documents may come from teaching and research institutions in France or abroad, or from public or private research centers.

L'archive ouverte pluridisciplinaire **HAL**, est destinée au dépôt et à la diffusion de documents scientifiques de niveau recherche, publiés ou non, émanant des établissements d'enseignement et de recherche français ou étrangers, des laboratoires publics ou privés.

From Vinylidene Fluoride (VDF) to the Applications of VDF-containing Copolymers: Recent Developments and Future Trends

AMEDURI Bruno *

Engineering and Macromolecular Architectures

Institut Charles Gerhardt UMR (CNRS) 5253

Ecole Nationale Supérieure de Chimie de Montpellier,

8, Rue Ecole Normale, 34296 Montpellier Cedex 5 (France)

Correspondance to: Bruno Ameduri (bruno.ameduri@enscm.fr)

Tel. +33-467-14-4368

Fax +33-467-14-7220

Key Words: Vinylidene Fluoride, (Conventional or Controlled) Radical (Co)polymerization, Kinetics, Elastomers, fuel cell membranes, cure site monomers.

Dedicated to Professor Bernard Boutevin on honor of his 60th birthday

CONTENTS

1. INTRODUCTION

2. SYNTHESIS and HOMOPOLYMERIZATION of VINYLIDENE FLUORIDE

2.1. Introduction

2.2. Synthesis of Vinylidene fluoride (VDF or VF₂)

2.3. Homopolymerization of Vinylidene fluoride

2.3.1. Radical Homopolymerization of VDF

2.3.2. Initiations Different from the Radical Ones

2.4. Properties of PVDF

2.5. Composites and Polymer Blends Made of PVDF

2.5.1. Composites

2.5.2. Polymer Blends

2.5.2.1. Introduction

2.5.2.2. PVDF/Ionomer Polymer Blends

2.6. Crosslinking

2.7. Processing of PVDF

2.8. Conclusion

3. COPOLYMERIZATION OF VINYLIDENE FLUORIDE

3.1. Introduction

3.2. Random Copolymers by Conventional Radical Polymerization

3.2.1. Poly(VDF-co-chlorotrifluoroethylene) Copolymers

3.2.2. Poly(VDF-co-trifluoroethylene) Copolymers

3.2.3. Poly(VDF-co-hexafluoropropylene) Copolymers

3.2.3.1. History and Characteristics of poly(VDF-co-HFP) Copolymers

3.2.3.2 Properties and Applications

3.2.3.3. Poly(VDF-co-HFP) Copolymers Involved in Energy Related-Applications

3.2.3.4. Poly(VDF-ter-HFP-ter-M) Terpolymers

3.2.4. Poly(VDF-co-tetrafluoroethylene) Copolymers

3.2.5 Poly(VDF-co-pentafluoropropene) Copolymers

3.2.6. Poly(VDF-co-3,3,3-trifluoropropene) Copolymers

3.2.7. Poly(VDF-co-bromofluoroalkenes) Copolymers

3.2.8. Poly(VDF-co-Hexafluoroacetone) and Poly(VDF-co-3-ketofluoroalkylglutaroyl halide) Copolymers

3.2.9. Poly(VDF-co-perfluoroalkyl vinyl ether (PAVE)) Copolymers

3.2.9.1 Introduction

3.2.9.2. VDF Copolymers Containing Non-functional PAVEs

3.2.9.3. VDF Copolymers Containing Functional PAVEs or PAAVEs

3.2.10. Poly(VDF-co-functional perfluorovinyl monomer) Copolymers

3.2.11. Radical Copolymerization of VDF with Fluoroacrylates

3.2.12. Radical Copolymerization of VDF with Other Monomers

3.2.13. Kinetics of Radical Copolymerization of VDF and Comonomers

3.2.14. Radical copolymerization of VDF with aromatic monomers

3.2.15. Conclusion

3.3. Random Copolymers Synthesized by Controlled Radical Polymerization

3.3.1. Introduction

3.3.2. Controlled Poly(VDF-co- α -Trifluoromethacrylic acid) Copolymers

3.3.3. Controlled Poly(VDF-co-Perfluoromethylvinylether) Copolymers

3.3.4. Controlled Poly(VDF-ter-HFP-ter-F₂C=CFSF₅) Terpolymers

3.3.5. Poly(VDF-co-Comonomer) Copolymers Controlled by Borinates

3.3.6. Poly(VDF-co-Comonomer) Copolymers Controlled via Xanthates

3.3.7. Conclusion

4. WELL-DEFINED COPOLYMERS BASED ON VINYLIDENE FLUORIDE

4.1. Fluorinated Block Copolymers Based on VDF

4.1.1. From Traditional (or Conventional) Radical Polymerization

4.1.2. From Controlled Radical Polymerization

4.1.3. Conclusion

4.2. Fluorinated Graft Copolymers

4.2.1. Introduction

4.2.2. From Conventional Radical Copolymerization

4.2.3. From Controlled Radical Copolymerization

4.3. Fluorinated Alternating Copolymers

4.4. Telechelics Containing VDF base-units

4.4.1. Telechelics from Functional Initiators

4.4.2. Telechelics from Fluorinated Telomers based on VDF

4.5. Chemical Modification of PVDF and VDF containing Copolymers

4.6. Conclusion

5. APPLICATIONS OF FLUOROPOLYMERS BASED ON VINYLIDENE FLUORIDE

6. CONCLUSION

7. LIST OF SYMBOLS AND ABBREVIATIONS

8. ACKNOWLEDGEMENTS

9. NOTES and REFERENCES

1. INTRODUCTION

Fluorinated polymers¹⁻⁵ are attractive niche macromolecules because of their versatility (they range from thermoplastics, elastomers, elastomers to thermoplastic elastomers and can be semi crystalline or totally amorphous) and their unique combination of relevant properties (mainly linked to the low polarisability and the strong electronegativity of the fluorine atom, to its small Van der Waals radius (1.32 Å) and to the strong C-F bond (485 kJ.mol⁻¹). Hence, fluoroplastics with high fluorine contents exhibit high thermal, chemical, ageing and weather resistance, excellent inertness to solvents, to hydrocarbons, to

acids and to alkalis, low surface energy (interesting oil and water repellency), low dielectric constants, low flammability, low refractive index, and moisture absorption. Furthermore, the presence of the strong C-F bond has a crucial impact on the high resistance to oxidation and to hydrolytic stability.

Hence, these speciality polymers¹⁻⁵ have found many applications: building industries (paints and coatings resistant to UV and graffiti), petrochemical and automotive industries, aerospace and aeronautics (use of elastomers as seals, gaskets, O-rings used in extreme temperatures for tanks of liquid hydrogen or hydrazine in boosters of space shuttles), chemical engineering (high performance membranes), optics (core and cladding of optical fibres), textile treatment, stone (especially coatings for old monuments), microelectronics. In spite of their high price (mainly linked to unusual processes of polymerization, to the cost of purifying the gaseous monomers and to the small scale of production), these polymers have found major developments in modern technologies.

However, fluoroplastics have various drawbacks: the homopolymers are often crystalline, hence inducing a poor solubility in common organic solvents and are not easily cured or crosslinked. This is why the generation of fluorinated copolymers⁴⁻⁸ (composed of a mixture of comonomers that inserts (bulky) side groups which produce disorder in the macromolecule, thus reducing or getting rid off the high crystallinity of the homopolymer) has extensively grown without possessing the disadvantages of homopolymers mentioned above.

2. SYNTHESIS and HOMOPOLYMERIZATION of VINYLIDENE FLUORIDE

2.1. Introduction

Because of its excellent combination of properties and processability, PVDF [24937-79-9] has become the largest volume of fluoropolymers after PTFE. Homopolymers derived from VDF (or VF₂) [75-38-7] are semi crystalline long chain macromolecules which contain 59.4 wt. % of fluorine and 3 wt. % hydrogen. The high level of intrinsic crystallinity (ca. 60 %) confers stiffness and tough, creep resistant properties rendering them suitable thermoplastics.

However, copolymers of VDF containing various comonomers can fall into three categories: i) when the amount of comonomers in the copolymer is small about that of VDF, the resulting materials are also thermoplastic with a lower crystallinity than that of PVDF⁹; ii) for a bit higher content of comonomer, thermoplastic elastomers can be obtained⁶⁻⁸; iii) for higher percentage(s) of comonomer(s), the produced copolymers are elastomeric, amorphous with low intermolecular forces.

Moreover, although PVDF has found interesting high tech applications (chemical process equipment, electrical and electronics, specialty and Energy-related applications, as mentioned in section 5), three major disadvantages are noted: i) high melting temperatures which generate energetic costs to enable the processing of this polymer; ii) poor solubility in common organic solvents (PVDF is soluble in dimethylformamide (DMF), dimethyl sulfoxide (DMSO), dimethyl acetamide, and N-methyl pyrrolidinone (NMP)) and iii) difficult curing of this material¹⁰.

Hence, fluorinated copolymers based on VDF have drawn more interest^{7,8,11}. The first copolymers of VDF were patented as early as 1948¹², produced in aqueous medium initiated by peroxides at 20-150 °C and under pressure (even above 300 atm), then followed by various generations of more and more VDF-based copolymers. Before describing PVDF and VDF-containing copolymers, it is useful to summarize the preparation of that monomer.

2.2. Synthesis of Vinylidene fluoride (VDF or VF₂)

VDF is a colorless, flammable and nearly odorless gas that boils at – 82 °C (its freezing point is – 144 °C). VDF's critical pressure, temperature and density are 4434 kPa, 30.1 °C and 417 kg.m⁻³, respectively, while its explosive limits are 5.8-20.3 vol.% in air. Its heat of formation is –345.2 kJ.mol⁻¹ at 25 °C, heat of polymerization at 25 °C is –474.21 kJ.mol⁻¹ whereas its solubility in water is 6.3 cm³/100 g at 25 °C and 10 kPa. VDF exhibits several advantages : it is non-toxic, environmental friendly fluorinated gas in contrast to chlorotrifluoroethylene (CTFE) and bromotrifluoroethylene (BrTFE), non-explosive contrarily to tetrafluoroethylene (TFE) or trifluoroethylene (TrFE), and can easily homopolymerize and copolymerize under radical initiation^{9,13}. In fact, acute inhalation toxicity of VDF is low. Median lethal concentration (LC₅₀) for rats was assessed: 128,000 ppm after 4hr-exposure¹⁴ and 800,000 ppm after 30 min-exposure¹⁵. Furthermore, cumulative toxicity is low: exposure of rats and mice at levels of up to 50,000 ppm for 90 days did not cause any systemic toxicity¹⁶. No teratogenic or reproductive effects were found in rats. 18 month-inhalation studies on rats and mice have not detected chronic or carcinogenic effects up to 10,000 ppm VDF¹⁷.

Various syntheses are possible to prepare VDF and a non-exhaustive list is given hereafter.

First, the chlorination of chlorofluorocarbon (CFC) 152 to 1-chloro-1,1-difluoroethane (HCFC 142b)¹⁸ followed by a dehydrochlorination at about 700-900 °C in the gas phase is the principal industrial process to VDF (Scheme 1).

INSERT SCHEME 1

HCFC-142b is the commercially preferred monomer precursor, obtained by hydrofluorination of acetylene¹⁹, vinylidene chloride²⁰ or 1,1,1-trichloroethane²¹.

The elimination can also be performed either at higher temperatures²², in the presence of copper catalyst²³, or at lower temperatures in the presence of steam.

Second, the hydrofluorination of 1,1,1-trichloroethane (HFC-143a) yields CFC 142²⁴ which is subsequently dehydrochlorinated as above (Scheme 2).

INSERT SCHEME 2

Third, the catalytic pyrolysis (at 400 °C in the presence of CrF₃, 3H₂O) of 1,1,1-trifluoroethane requires specific conditions but produces VDF in high yield and purity²⁵.

Fourth, dehydrobromination of 1-bromo-1,1-difluoroethane²⁶ and dechlorinations of 1,2-dichloro-1,1-difluoroethane²⁷ and of other intermediates¹³ have also been investigated as alternative routes (Scheme 3), and other well-reviewed by Dohany and Humphrey¹³.

INSERT SCHEME 3

Deuterated VDF was prepared^{28,29} from trifluoroethanol-d₃, which was chemically changed into CF₃CD₂I that further underwent reaction with magnesium, and gave F₂C=CD₂ in 44 % overall yield.

2.3. Homopolymerization of Vinylidene fluoride (VDF)

2.3.1. Radical Homopolymerization of VDF

Poly(vinylidene fluoride), PVDF or PVF₂, is usually manufactured from radical initiated batch polymerization process in aqueous *emulsion* or *suspension* (involving pressures of 10-300 atm) and temperatures 10-130 °C, regarded as heterogeneous reactions requiring a fluorinated surfactant. Chain transfer agents or buffers, or both, may be used. Water soluble initiators for the process can be persulfate salts³⁰, disuccinic acid peroxide³¹, β-hydroxyalkylperoxide or alkylperoxybutyric acid³².

Organosoluble initiators³³ involved in the second process are diisopropylperoxydicarbonate^{33b-e}, *tert*-butylperoxypivalate^{33g} or *tert*-amylperoxypivalate^{33g} or *ditert*-butyl peroxide³³ⁱ while water soluble polymers such as cellulose derivatives, or poly(vinyl alcohol) are used as suspending agents to reduce coalescence of polymer particles.

Finally, *solution* polymerization^{34,35} has also been investigated initiated by organic peroxides (such as bis(perfluoropropionyl) peroxide^{34a}, bis-4-tert-butylperoxycyclohexyldicarbonate^{34b} or *tert*-butylperoxypivalate³⁵) in which the oxygen-oxygen bond undergoes a homolytic scission, in the presence of chlorofluorinated solvents.

Polymerization procedures, temperatures, pressure, recipe ingredients, monomer feeding strategy, and post-polymerization processing are variables that influence product characteristics and quality and is discussed in the well-documented reviews^{9,13}.

Suspension and *emulsion* polymerized –VDF exhibit dissimilar behaviors in solution. The suspension resin is readily soluble in many solvents (DMF, NMP, DMSO, dimethylacetamide).

*Radiation*³⁶ or *plasma*³⁷ induced polymerizations of VDF have also been successfully carried out while the *microwave*-stimulated polymerization gave thin polymeric PVDF films (<10 μ m)³⁸.

Interestingly, DeSimone's group has extensively investigated³⁹ and also reviewed⁴⁰ the radical polymerization of VDF in supercritical (sc) CO₂. Then, a British group⁴¹ and a German team⁴² have also been active in that area. This technology offers the advantage in the polymer isolation step where a clean dry polymer is produced simply by depressurization. The residual monomer(s) and CO₂ can be recycled back to the reactor. Adequate CO₂ density for polymerization required pressure significantly higher (typically > 100 bar) than conventional emulsion or suspension polymerizations. As PVDF is not soluble in sc CO₂, a continuous precipitation polymerization of VDF was also investigated leading to the formation of polymers having bimolecular weights distributions⁴³.

Regarding the kinetics of radical homopolymerization of VDF, the propagation rate to the square root of the termination rate of VDF has been assessed in solution (0.14 L^{0.5}.mol^{-0.5}.s^{-0.5} at 74 °C)⁴⁴ and in sc CO₂ (1.3 L^{0.5}.mol^{-0.5}.s^{-0.5} at 120 °C³⁹ and 2.23 L^{0.5}.mol^{-0.5}.s^{-0.5} at 120 °C⁴²).

In the course of the propagation, the contents of -CH₂CF₂-CH₂CF₂- head-to-tail normal and -CH₂CF₂-CF₂CH₂- head-to-head or -CF₂CH₂-CH₂CF₂- tail-to-tail reversed VDF-VDF diads have been assessed by high resolution ¹⁹F⁴⁵ (Figure 1) and ¹H nuclear magnetic resonance (NMR) spectroscopy. These head-to-head or tail-to-tail defects are influenced by the polymerization process conditions and temperature. In contrast to suspension polymerized VDF, PVDF obtained from the emulsion process contains a higher fraction of head-to-head defects. Commercial grades exhibit a wide range of 3-7 mol. % defect structures. Recently,

the structure of α PVDF and a VDF telomer (VDFT) have been investigated by solid-state NMR (MAS) using magic angle spinning (MAS) with relaxation pulse sequences^{45h}. Here the degree of crystallinity, defect units and end group content can be determined. The VDFT showed to have the β all trans form, but with similar defect unit content and a higher degree of end chains than α PVDF. It was also shown using a pre spin-lock with radio frequency dipolar recoupling (RFDR), that the defect units are confined to the amorphous domain. Wormald's group has also recently developed a new method for NMR experiments on PVDF using 'discrimination by variable amplitude multipulses' where selectivity is based on relaxation and/or chemical shift anisotropy and will shortly be publishing the results from a very fast MAS with back to back (BABA) dipolar recoupling experiments on PVDF to analyze the contributions to the amorphous NMR lineshape.

In summary, crystallinity which affects toughness, mechanical strength, impact resistance and other properties of PVDF are influenced by the defect structures⁴⁶.

Controlled radical polymerization (CRP)⁴⁷ of VDF has been scarcely investigated and successful attempts concern iodine transfer polymerization (ITP)^{44,48} (indeed, ITP of VDF was pioneered in the late 70ies at the Daikin Company⁴⁸), macromolecular design through interchange of xanthate⁴⁹ (MADIX) (for which one example only has been supplied for the radical polymerization of VDF⁵⁰) and borinates⁵¹. Further details on the radical controlled copolymerization are supplied in section 3.3.

INSERT FIGURE 1

Nowadays, thermoplastic elastomers based on VDF (see sections 4.1.2 and 4.2.2) are currently produced at the industrial scale.

Termination of the radical polymerization of VDF proceeds exclusively through recombination⁵².

Highly regular PVDF polymer with minimized defect structure was first pioneered by Cais⁵³ (2.8 %) for the high molecular PVDF while VDF telomers (DP₁₁ and DP₂₀) were recently achieved and contained 0.73 % head-to-head defects of chaining⁵⁴. In addition, pure isogeric PVDF was achieved by reductive dechlorination of low molecular weight poly(1,1-dichloro-2,2-difluoroethylene)⁵⁵.

The synthesis of deuterated PVDF has also been reported Cais and Kometani^{29,56} with higher melting point and molecular weight, and enhanced crystallinity arising from a "more perfect

chain structure” than those of “hydrogenated” PVDF. In fact, the maximum remanent polarization attained with deuterated PVDF homopolymer film was $1.0 \text{ mC}\cdot\text{cm}^{-2}$.

2.3.2. Initiations Different from the Radical Ones

Trialkyl aluminum⁵⁷ and other low temperature systems^{29,58} have shown to be efficient “initiators” which generate low defects of chaining (< 2.4 %). In addition, the polymerization of VDF initiated by alkylboron compounds activated by oxygen, pioneered by Natta *et al.*⁵⁹ in 1965 was later on investigated by Chung’s group⁵¹. Interestingly, that system is able to control the polymerization of VDF via the $^{\circ}\text{OBR}_2$, a stable radical which acts as a counter radical (as reported in section 3.3.5).

2.4. Properties of PVDF

Among polyfluoroethylenes, PVDF is a thermoplastic that exhibits interesting properties. Physical and electrical characteristics of PVDF have been reported in various reviews^{9,13} and depend upon the molecular weights, molecular weight distributions, the chain configurations, the crystalline form (see below) and the defects of chaining⁴⁶. Among these properties, PVDF is attractive for its piezoelectric (Kawai⁶⁰ discovered that behavior in 1969), pyroelectrical (first reported in 1971 by Bergman *et al.*⁶¹ and by Nakamura and Wada⁶²) and ferroelectric⁶³ behaviors. β Form PVDF has even superior dielectric permittivity arising from the strong polymerization originating from C-F bonds and the spontaneous orientation of dipoles in the crystalline phases (Figure 2).

PVDF is inert to various solvents, oils, acids and shows low permeabilities to gases and liquids. The glass transition (T_g) and melting (T_m) temperatures of the amorphous and crystalline PVDF regions are in the range of - 40 to - 30 and 155 to 192 °C, respectively, depending on the sample (e.g., the molecular weight and the amount of defects of chaining) and the testing method.

In fact, PVDF is typically 50-70 % crystalline with five distinct crystal polymorphs named α , β , γ , δ , and ϵ , though α , β , and γ are the most frequent (Figure 2). This polymorph is directly related to the slightly larger van der Waals radius of fluorine atom (1.35 Å) *versus* that of hydrogen one (1.20 Å). Indeed, these five types of crystalline phases in PVDF⁶⁴ are a scarce characteristic for synthetic homopolymers. Most popular is the α phase (form II) having a trans-gauche configuration in which the polymeric chains are in non-polar conformation (*TGTG'*), hydrogen and fluorine atoms alternating in a regular way on both

sides of the chain⁶⁵, giving a helix type structure (Figure 2). The α form is the most thermodynamically stable form. The polar crystalline phase β (form I) which has zig-zag (all-trans) conformation (*TTT*) of the polymeric chains, and is obtained by straining, stretching, or quenching⁶⁶. The β -phase is most intriguing due to its piezo-, pyro-, and ferroelectric properties⁶⁴, that originates from the orientation of the strong dipole in the $-\text{CH}_2\text{CF}_2$ -base units along the polymeric chain. The intermediate polar conformation (*TTTGTTG*) phase γ (form III) is formed when the polymer is moderately stressed or when high-temperature annealing is applied. These different crystalline phase structures have already been characterized^{64,67,68}. Amorphous PVDF regions have a density of 1.68, the α and γ polymorphs 1.92 and 1.93, respectively, while that of β polymorph is 1.97 $\text{g}\cdot\text{cm}^{-3}$. The melt density of PVDF homopolymer is ca. 1.45-1.48 $\text{g}\cdot\text{cm}^{-3}$ at 230 °C and 1 bar. From wide-angle diffraction, Abbrent *et al.*⁶⁹ characterized the parameters of the orthorhombic unit cell typical of the α phase ($a = 4.96 \text{ \AA}$; $b = 9.64 \text{ \AA}$ and $c = 4.62 \text{ \AA}$).

INSERT FIGURE 2

Dielectric constant and dissipation factor at 25 °C are 8.15-10.46 and 0.005-0.026 at 1 kHz, respectively, while the Curie temperature of PVDF has been assessed (197 °C⁷⁰ and 195-197 °C⁷¹).

Recently, Arkema tailored various homopolymers of VDF to obtain unexpected morphologies of PVDF. Long chain branches (LCB) were synthesized using potassium persulfate and *n*-butyl-4,4-bis(tert-butylperoxy)valerate^{72,73}. The number of branch points per 1000 monomer units was assessed by NMR to be in the 4.0-4.8 range while for “reference Kynar® PVDF”, this number ranged between 0.8 and 3.1. The higher the initiator concentration, the greater the number of branch points, which is well characterized by multiangle light scattering and viscosimetry data. These authors claim that these LCB PVDFs should find new applications in melt processing⁷³.

PVDF has shown organic permselectivity in the pervaporative separation of volatile organic compounds / water mixture⁷⁴.

Thanks to its remarkable properties, PVDF has been extensively used as component of electrolyte and Li-ion batteries (Figure 3), either as a binder for electrode materials⁷⁵ or as plasticized microporous PVDF separators for Li-ion batteries⁷⁶.

INSERT FIGURE 3

Indeed, recent electrolytes consist of a macroporous PVDF separator, the polymeric backbone of which is swollen by the liquid electrolyte while the porous volume is filled with the liquid electrolyte⁷⁷.

2.5. Composites and Polymer Blends Made of PVDF

2.5.1. Composites

Blends made of PVDF with nanofillers or clay to produce nanocomposites have been investigated and four examples are given hereafter. Chung's group⁷⁸ prepared n-composites based on PVDF as an original polymeric surfactant, which showed interfacial activity in the exfoliated fluoropolymer/clay nanocomposite. The functional group anchors the polymer chain to the clay interface. The rest of the unperturbed high molecular weight hydrophobic and oleophobic fluoropolymer chain which dislikes the hydrophilic clay surfaces, exfoliated the clay layer structure, and the disorder is maintained even after mixing.

Similarly, Dillon *et al.*⁶⁴ investigated the nanoclay/PVDF composites but by both solution casting and co-precipitation method and using three n-clay morphologies (exfoliated, partially intercalated, and phase separated morphologies). In solution cast samples, phase separation and intercalation occurred, depending upon the organic modifiers, while complete exfoliation of the n-clays was noted in the co-precipitated n-composites.

Priya and Jog⁷⁹ obtained PVDF/ clay n-composites by melt intercalation (in a Brabender) with organophilic bentonite clay (Cloisite 6A-treated with dimethyl dehydrogenated tallow quaternary ammonium chloride) and noted that: i) PVDF in the n-composites crystallized in the β form^{79a,b} (which was stable after thermal annealing performed at 125 and 185 °C^{79c}); ii) an enhanced rate of crystallization with the addition of clay, and iii) significant improvement in the storage modulus over the temperature range of – 100 to 150 °C^{79a}.

More specifically, Lui *et al.*⁸⁰ studied the effect of montmorillonite clay containing various quaternary alkylammonium salts for the preparation of gel PVDF n-composite electrolytes. These original electrolytes could be obtained by the addition of an appropriate amount of DMF or ethylene carbonate (EC)/propylene carbonate (PC) (acting as suitable co-solvent between PVDF and the clay), the organophilic clay and the lithium perchlorate to PVDF. The resulting materials showed better films formation, solvent maintaining capability, dimensional and electrochemical stabilities, and enhanced ionic conductivity (up to 10.3 mS.cm⁻¹) than electrolyte films without any added organophilic clays.

2.5.2. Polymer blends

2.5.2.1. Introduction

The interest of polymer blends⁸¹ lies in i) obtaining properties different from those of parent homopolymers and copolymers, ii) improving the physical properties (mainly mechanical), iii) easy preparation and iv) a wide versatility of these blends.

Indeed, varying the blend composition induces a great variety of products endowed with a wide range of properties. However, such blends require to be miscible or partly miscible, to enable the resulting materials to exhibit interesting properties.

Unlike most crystalline polymers, PVDF exhibits thermodynamic compatibility with other polymers⁸² and blends of PVDF with various other homopolymers was partly reviewed^{64,82}. Viscometric behaviors of polymer blends based on PVDF have been also extensively investigated⁸³. Among homopolymers which have led to many studies, poly(methyl methacrylate), PMMA, is miscible over a wide range of composition⁸⁴ (isotactic PMMA being more miscible with PVDF than atactic and syndiotactic one⁸⁵) and many investigations have revealed H-bonding between the carbonyl group of PMMA and the protons of PVDF⁸⁶. Addition of 10-30 wt. % PMMA improves the transparency of PVDF films or coatings in the UV-visible spectrum. The relationship between the optical transmission and compatibility of PVDF/PMMA blends have shown that films made of the blends containing at least 15 wt. % PMMA are very transparent.

Specific PVDF/ poly(methacrylate) blends have led to various interesting products for paints and coatings; one of them, Kynar®, is marketed by Arkema (formerly Elf Atochem, Atofina, or Total Fina Elf).

The behavior of the PVDF/PMMA blend from solutions was revisited by Ma *et al.*⁸⁷. The crystallization behavior and morphology of the films cast from the mixed solvent (THF/DMF) revealed an enormous dependence on the DMF content. Indeed, the increased DMF content in the mixed solvent enhanced the interactions between polymers and solvents, and favored the β -crystal of PVDF formation but hindered the α -phase of PVDF formation.

Compatibilized blends of PVDF and thermoplastic polyurethane (TPU) have been developed using maleated PVDF (PVDF-g-MA) and investigations on the rheology, morphology and mechanical properties of these blends have been achieved⁸⁸.

Polyamide 11 (PA11)/clay blends, (PVDF)/clay blends and ternary PVDF/PA11/clay blends were obtained by melt processing (using a high shear extruder) to prepare nanocomposites⁸⁹. Two types of organoclays with different modified alkyl tails and different polarities were used

for PA11 and PVDF nanocomposites. PA11 nanocomposites derived from an organoclay having one alkyl tail show a well-exfoliated morphology but no crystal form transformation, whereas those derived from an organoclay having two alkyl tails give a little less clay dispersion with the clear α to γ crystal form transition with the addition of the clay. In contrast, the PVDF composites derived from the two organoclays gave a poor dispersion. It was found that the clay platelets were selectively dispersed in the PA11 phase for a size larger than 200 nm, while no clay platelets were located in the PVDF phase and in the PA11 nanodomains with the size of smaller than 200 nm.

Another approach regarding PVDF/nylon-6 (N6) 30/70 blends with various modified montmorillonite clays (Cloisite 30B and Cloisite 20A) was achieved by melt compounding⁹⁰. Giannelis' team⁹⁰ investigated the morphological, thermal, and mechanical properties of the resulting blend nanocomposites. These authors have found that the degree of compatibilization induced by the nanoclay particles was dependent on both the location of the particles and the degree of clay dispersion. The blend nanocomposite with the best mechanical properties (Figure 4) had good dispersion of particles throughout the N6 matrix and at the PVDF/N6 interface, as sketched by Figure 5. In this blend nanocomposite, the coalescence of PVDF domains was prevented, and the crystallization of the PVDF domains was suppressed, ultimately creating a blend nanocomposite that is stiffer, stronger, and tougher than the blend without any nanoparticles (Figure 4).

INSERT FIGURES 4 & 5

On the other hand, quite a few PVDF/F-polymer blends have been published in the literature and it is of interest to mention Olkhov *et al.*'s basic survey⁹¹ on the morphology of PVDF and its isomer: the poly(ethylene-alt-tetrafluoroethylene) copolymer, ETFE, by thermomechanical analysis. This characterization showed that the polymers had completely amorphous "diblock" morphology. Parameters that characterize a degree of interchain interaction, such as coefficients of thermal expansion, free volume, and temperatures of polymer transformation into the glassy, high-elastic, or flow-viscous state were determined. PVDF and ETFE have similar topographic composition, but different molecular mass and temperatures of phase transitions.

2.5.2.2. PVDF/Ionomer Polymer Blends

One of the most attractive applications of these blends concern the preparation of proton conducting-polymeric membranes, used as electrolytes in the so-called proton exchange

membrane fuel cell (PEMFC, Figure 6). For example, Scrosati's team^{92a} synthesized original composite poly(acrylonitrile), PAN / PVDF hollow blend based - membrane dispersed n-Al₂O₃ ceramic filler swollen by aqueous acid solutions (phosphoric, sulfonic or trifluoroacetic acids) as a gel-type polymer electrolyte^{91a}. These acids were claimed to ensure the protonic conductivities keeping the same values (ca. 0.1 S.cm⁻¹) from 25 to 85 °C, though MEA performances were poor (only 2 mW.cm⁻² as a maximum of power density at room temperature). In a basic study, the same group^{92b} also investigated the structure of PVDF / polyacrylonitrile blends for such applications by vibrational spectroscopy. By comparing the dissociation degree and the actual amount of acid in the membrane to the conductivity, the limiting factor for the conductivity was established as the long-range mobility of protons, which is governed by the morphology of the membrane.

INSERT FIGURE 6

Another strategy from Mokrini *et al.*⁹³ concerned the preparation of functional polymer blends for polymer electrolyte membrane for fuel cell (PEMFC) from PVDF and a styrene-ethylene/butylene-styrene (SEBS) thermoplastic elastomer as a compatibilizer, after two different processes: i) twin-screw extrusion and then calendring^{93a} or ii) melt blending and extruded into films^{93b}. The resulting films were then reacted with sulfonic acid to enable the proton conductivity. The interest to insert the additive is demonstrated by scanning electron microscopy (SEM). The SEM picture shows the phase separation for a blend which does not contain any compatibilizer (Figure 7a) and a significant reduction of the size of the phase when the additive was present (Figures 7b and 7c). SEBS is a phase-segregated material where the polystyrene blocks can be selectively functionalized offering high ionic conductivity, while PVDF insures good dimensional stability and chemical resistance to the films. The compatibilized blend membranes prepared in the first case, showed higher conductivities, 5.5×10^{-3} to 1.9×10^{-2} S.cm⁻¹^{93a}, and improved water management compared to those achieved from the second process. Water swelling decreased for compatibilized blend membranes. Adding a PMMA-b-poly(butyl acrylate)-b-PMMA block copolymer^{93a} also enabled the compatibility of the blend by reducing the segregation scale and improving the blend homogeneity. These Canadian authors also studied the effect of varying the nature and concentration of the compatibilizer on the morphology and properties of a 50/50 wt. % PVDF/SEBS blends.

INSERT FIGURE 7

For a similar application, Wootthikanokkhan's group⁹⁴ investigated PVDF / polystyrene sulfonic acid (PSSA) blends using compatibilizers such as PS-b-PMMA diblock and PMMA-b-PSSA-b-PMMA triblock copolymers. They studied the effects of blend ratio onto the thermal and electrochemical properties of the resulting blend membranes (water uptake, proton conductivity, and methanol crossover). Interestingly, 5 % only of PS-b-PMMA diblock copolymer (for which the PMMA segment was compatible with PVDF and PS compatible with PSSA) remarkably increased the resistance to methanol crossover, the proton conductivity (though the maximum value was $3.9 \text{ mS}\cdot\text{cm}^{-1}$), and the mechanical properties (the tensile strength was 12 MPa), taking into account that blending PSSA with PVDF enabled the PSSA to reduce its degradation⁹⁵. Further, the blends were stable up to 300 °C.

In addition, Nasef, *et al.*⁹⁶ prepared pore-filled membranes composed of PSSA anchored in microporous PVDF films (by radical polymerization of SSA in the pores of PVDF). The variation of PSSA content induced changes in the structure of the membrane matrix. The porosity of the membranes decreased with increasing PSSA content without reaching a complete plugging of some pores in PVDF matrixes. Liquid uptake was dependent on the degree of crystallinity of the polymer electrolyte. Such a procedure was revisited by Moszczynski *et al.*⁹⁷ who obtained membranes, the proton conductivities of which reached $100 \text{ mS}\cdot\text{cm}^{-1}$ between 20 and 90 °C. However, and as expected, for higher temperatures, that conductivity value drops drastically because of the drying of the membranes. In addition, these membranes exhibit drawback of ageing in water since ca. 77 % of the initial weight of PSSA was eluted after 32 days in water.

Another elegant and original strategy to blend PVDF and PSSA for fuel cell applications was developed in Prakash's group⁹⁸. This involves the preparation of semi interpenetrated polymer network (sIPN) by immersing a PVDF membrane into a mixture of styrene monomer and divinyl benzene crosslinker prior to carry out the polymerization of styrene initiated by AIBN (Scheme 4).

INSERT SCHEME 4

Then, the sIPN membrane was impregnated in chlorosulfonic acid to insert sulfonic acid function on the aromatic rings for the proton conductivity. The compatibility of PSSA and PVDF arose from the crosslinked structure in the sIPN, restricting the phase separation between both homopolymers. PVDF/ Nafion® blends led to original fuel cell membrane with

attractive electrochemical properties (Figure 8), comparable conductivity values with Nafion® (ca. 77 mS.cm⁻¹ at 25 °C), and a much lower methanol crossover (decrease of ca. 95 % about that of Nafion®). Such a strategy was efficiently used for direct methanol fuel cell^{99,100}.

INSERT FIGURE 8

Furthermore, Goldbach *et al.*¹⁰¹ prepared polymer electrolyte fuel cell membranes by blending Kynar® PVDF and polyelectrolyte (based on aromatic sulfonic acid) (thickness 25 µm) and compared their electrochemical properties to those of Nafion®112 (thickness 50 µm). They noted a lower methanol crossover and better chemical and thermal stabilities (less than 1 % loss of small sulfur-containing molecules after 2000 hrs, in contrast to Nafion® 112 which lost ca. 50 %). Though the conductivity values were a bit lower (130-150 mS.cm⁻¹ by adjusting the processing, compared to 160 mS.cm⁻¹ for Nafion®112), the obtained membranes had superior gas crossover resistance and tear properties while the water uptake was higher (60 % compared to 37 % for Nafion®112).

The morphologies of these novel PEMFCs were evaluated by TEM, before and after incorporation of the membrane into a membrane electrode array. Nanometer-scale changes of the polymer structure and changes in the spatial distributions of fluorine, sulfur and other elements were analyzed. The effects of microstructural and microchemical observations were correlated to the changes in fuel cell performance with time¹⁰¹. The Arkema company¹⁰² also obtained relevant fuel cell membranes by blending Kynar® PVDF with various polyelectrolytes prepared by chemical modification of poly(vinylalcohol), poly(vinylbenzylchloride), and poly(paraacetoxystyrene) as in Scheme 5.

INSERT SCHEME 5

Rather thin (25-50 µm) membranes were used for membranes electrode assemblies (MEAs)¹⁰². These polyelectrolyte resins blended into a polymer or copolymer matrix. Specifically, the polyelectrolyte resins are (co)polymers without hydrolyzable groups. The Kynar® PVDF was required as tough, and highly chemically-resistant (co)polymer.

For the same fuel cell membrane application, sulfonated PEEK / PVDF blends have also been investigated by several authors¹⁰³ for direct methanol fuel cell (DMFC) since the methanol

crossover is 20 times lower than that of Nafion®^{103b}, though the power density was 30 mA.cm⁻² only at 60 °C^{103b}.

Jung and Park^{103c} showed that less than 10 wt. % of PVDF was enough to bring mechanical stability to avoid the phase separation (since for a high PVDF content, two Tgs were noted), and led to satisfactory conductivities (10⁻² S.cm⁻¹ at 60 °C) with similar fuel cell performances as those of Nafion® (Figure 9).

INSERT FIGURE 9

More recently, Arunbabu *et al.*¹⁰⁴ have also studied polybenzimidazole (PBI) / PVDF blends showing by FTIR that hydrogen bonding interactions occurred between N-H bond of PBI and difluoromethylene groups of PVDF. DSC evidenced miscibility of these polymers in a wide composition range, by the presence of a unique Tg, the value of which was always ranging between that of PVDF (claimed at - 44 °C) and that of PBI (+ 433 °C) (Figure 10). The experimental values were in good agreement with those predicted from the Gordon-Taylor equation (in which the adjustable fitting parameter related to the strength of the intermolecular interaction between both homopolymer was 1). Such a miscible blend was cast into a proton exchange membrane fuel cell doped with phosphoric acid (PA). Though no values of conductivity have been supplied, the PA doping level of the blend membrane improved significantly as a result of the hydrophobic nature of PVDF which suppressed the water uptake.

INSERT FIGURE 10

To enhance the porosity, PVDF was prepared by phase inversion method using as an additive, PEG (poly(ethylene glycol))¹⁰⁵, with N,N-dimethylformamide as a solvent. Uniformed sponge structure of PVDF-PEG membrane for the lithium secondary batteries was prepared with 10 wt. % of PEG concentration in the PVDF-PEG solution. Porosity, elongation and tensile strength of the membrane were 87%, 75%, and 275 MPa, respectively¹⁰⁵.

Yang *et al.*¹⁰⁶ investigated the effect of lithium iodide concentration on the conduction behavior of poly(ethylene oxide)-poly(vinylidene fluoride) (PEO-PVDF) polymer-blend electrolyte and the corresponding performance of the dye-sensitized solar cell (DSSC). The conduction behavior of these electrolytes was investigated with varying LiI concentration (10-60 wt % in polymer blend). The optimized conversion efficiency is obtained at a salt content

of 28.9 wt % in the "polymer-in-salt" region, with an ionic conductivity of $1.06 \times 10^{-3} \text{ S.cm}^{-1}$. Based on these facts, the changes of conduction behavior and the changes of I^{3-} and I^- concentrations in the electrolytes were suggested to contribute to the final performance variation of the corresponding DSSC with varying LiI concentration.

Another interesting topic related to blends made of PVDF deals with artificial muscles. Indeed, to develop artificial muscles with improved performance, electro-active polymer actuators are search and, among various examples¹⁰⁷, Lu *et al.*¹⁰⁸ prepared a new one by employing an ionic networking membrane of poly(styrene-alt-maleimide) (PSMI)-incorporated PVDF in the presence of platinum particles¹⁰⁷. Scanning electron microscope (SEM) and transmission electron microscopy (TEM) revealed that smaller and uniform platinum particles were formed on the surfaces of the actuator fabricated through the electroless-plating technique as well as within its polymer matrix. Under constant voltage excitation, the tip displacement of the actuator constructed with that ionic network membrane was several times larger than that of its Nafion[®] counterpart of similar thickness without straightening-back. Under the stimulus of alternating-current voltage, this actuator displayed an excellent harmonic performance, and the measured mechanical displacement was comparable to that of the Nafion[®]-based actuator (a tactile sensor is sketched in Figure 11), with an inherent large ionic-exchange capacity and unique hydrophilic nanochannels of the ionic networking membrane, hence finding niche applications in biomimetic motion.

INSERT FIGURE 11

2.6. Crosslinking of PVDF

Crosslinking of polymers usually enables to enhance their properties. In the case of PVDF, various ways involving different crosslinking agents have been investigated reported recently¹⁰: aliphatic diamines, bisphenols, peroxide/triallyl (iso)cyanurate systems, from PVDF –containing cure site monomers (CSMs), or from electron beam irradiation. Indeed, PVDF has been used in the last 30 years in nuclear radiation environments because unlike most plastics it crosslinks, retaining mechanical integrity, rather than degrades.

2.7. Processing of PVDF

PVDF is available in a wide range of melt viscosities as powders and pellets to fulfill typical fabrication requirements^{5,9}. It can be molded in conventional compression, transfer and

injection-molding equipment¹⁰⁹. As a crystalline polymer, it shows a relatively high mold shrinkage of ca. 3 %. Further data on the processing can be found in the comprehensive reviews written by Seiler⁵, Humprey and Sanayed⁹, or Dohany¹³.

As mentioned above, Hedhli *et al.*^{72,73} evidenced by rheology possible branching in PVDF (indeed, these authors claimed that long chain branching (LCB) naturally occurs in emulsion polymerization of VDF), arising from hydrogen abstraction of a methylene group surrounded by two CF₂ groups.

PVDF is available commercially in a wide range of melt flow rates and with various additives to enhance processing or end use properties. PVDF is not hazardous under typical melt processing conditions. A variety of forms are available-latex and fine powders from emulsion processes and granules from either suspension or emulsion processes.

All common extrusion and molding techniques can be used to process PVDF into shapes. Typical molding temperatures in the cylinder and nozzle are 180-240 °C for injection types, and for molds are 50-90 °C.

Certain additives such as titanates or silicates catalyze the thermal decomposition of molten PVDF at temperatures lower than typical for the natural resin, leading to dangerously high pressures in the equipment because of by-product gases. Generally, metal oxide-catalyze degradation at high processing temperature, e.g., oxides of titanium, managanese, and of iron.

2.8. Conclusion

PVDF is an exceptional polymer endowed with remarkable properties, involved in many high-Tech applications. When the term PVDF is used to search the Chemical Abstract databases from 1992, there are approximatively 500 citations per year, about half of which are patents, showing a growing industrial interest. The world wide PVDF market in 2000 was about 21,000 tons⁹. PVDF usage is expected to grow at an average of about 6 % for all fluoropolymers in that first decade of the XXIst century. The processing, morphology, properties, and end-use performance are affected by the branching, crosslinking, differences in the content of defect structures, and other chain irrregularities.

3. COPOLYMERIZATION OF VINYLIDENE FLUORIDE

3.1. Introduction

Copolymerization is the most general and powerful method to perform effective systematic changes in polymer properties, and is widely used in the production of commercial polymers and in basic investigations of structure-properties relations. As a result, copolymerization usually modifies the symmetry of the polymeric chain and modulates both intramolecular and intermolecular forces, so that properties such as melting point, glass transition temperature, crystallinity, stability, elasticity, permeability and chemical reactivity may be varied within wide limits.

As well-known, the (co)polymerization of fluoroalkenes is carried out in a radical way.

Regarding the behavior in solution of VDF-containing polymers, little data is given in the literature^{110,111} in contrast to the Mark-Houwink relationships to determine molecular-weights of PVDF^{112,113}. The intrinsic viscosity-molecular weight empirical relationship according to Mark-Houwink-Sakurada was first suggested by Lutinger and Weill¹¹⁴ ($K = 4.5 \cdot 10^{-2} \text{ mL.g}^{-1}$ and $\alpha = 0.70$ at 25 °C in DMF).

To our knowledge, the most pertinent studies were achieved by Zimbo and Theodore¹¹⁰ and by Maccone *et al.*¹¹¹ who determined key molecular-weight parameters by size exclusion chromatography, such as the average molecular-weights and molecular weight-distributions. The latter team also investigated the branching of PVDF from the transfer to the polymer and then the crosslinking in the presence of a fluorodiolefin¹¹¹.

As for the radical homopolymerization of VDF, initiators can be commonly used such as potassium or ammonium persulfates (emulsion process) or peroxides (suspension and solution processes).

In this part, most VDF copolymers are random (3.2) but in further sections, useful data report the formation of alternating poly(VDF-alt-M) copolymers, and then on well-defined VDF-containing fluoropolymers.

As a matter of fact, four types of VDF-based fluoropolymers⁶⁻⁸ are manufactured:

the earliest types of fluorocarbon elastomers are those prepared from VDF and HFP (type-A)^{13,26}; later, the B types were developed; they contain VDF, HFP and TFE base units^{6,8,115}; fluoroelastomers designated as type-C were prepared to improve the solvent resistance; they contain a higher fluorine content and cure-site monomer (CSM) such as bromotrifluoroethylene in addition to VDF, TFE and HFP; the most recent ones are called type-D fluoroelastomers endowed with low-temperature resistance and containing perfluoroalkyl vinyl ether instead of HFP (Table 1).

INSERT TABLE 1

3.2. Random Copolymers by Conventional Radical Copolymerization

Copolymers based on VDF and chlorotrifluoroethylene (CTFE) or hexafluoropropene (HFP) represent the most important nowadays production among the thermoplastic copolymers of VDF while such a positive fate was reached for poly(VDF-co-HFP) elastomers produced by most industries of fluoropolymers.

3.2.1. Poly (VDF-co-chlorotrifluoroethylene) Copolymers

The first copolymers based on VDF and chlorotrifluoroethylene (CTFE) were produced for military interests from 1955¹¹⁶. Poly(VDF-co-CTFE) copolymers are statistic having a chemical structure as $[(\text{CH}_2\text{CF}_2)_x(\text{CF}_2\text{CFCl})_y]_n$ and are widely used in the current industry. In the mid-50ies, these materials were also the first commercially available fluoroelastomers (from the Kellogg Company under the Kel[®] F trademark) with vulcanizate properties higher to any of those existing. Nowadays, according to the properties and applications required, various poly(VDF-co-CTFE) copolymers are proposed, the amount of CTFE being crucial. On the one hand, this amount may influence the glass transtion temperature (T_g) of the poly(VDF-co-CTFE) copolymers, the assessment of which was investigated for the first time by Mandelkern *et al.*¹¹⁷ in 1957: according to the composition, it ranges between $-40\text{ }^\circ\text{C}$ (T_g of PVDF) to $45\text{ }^\circ\text{C}$ (T_g of PCTFE).

On the other hand, poly(VDF-co-CTFE) copolymers with small VDF content is a semicrystalline copolymer with a hexagonal structure¹¹⁸, while that containing 25-70 mol. % VDF is amorphous though it has also been more recently noted¹¹⁹ that poly(VDF-co-CTFE) copolymers containing more than 16.6 mol. % of CTFE units had an amorphous state (Figure 12). VDF-based fluoroelastomers have remarkable resistance to flames, chemicals, solvents, heat and oxidation. These materials can be cured by bis-nucleophiles such as bis-phenols or diamines or by peroxides¹⁰.

INSERT FIGURE 12

VDF percentages higher than 70 % lead to thermoplastic, the crystalline structure of which was reported as monoclinic¹²⁰ and these copolymers are called flexible PVDF¹²¹.

The synthesis of poly(VDF-co-CTFE) copolymers can be carried out in emulsion¹²² or in suspension¹²³.

The microstructure of poly(VDF-co-CTFE) copolymers was assessed for the first time by Murasheva *et al.*¹²⁴ from a careful ¹⁹F NMR characterization and was revisited by Chung's team¹²⁵ (who surprisingly did not quote these Russian pioneers).

As reported above for PVDF, poly(VDF-co-CTFE) copolymers are also endowed with piezoelectrical properties, discovered in 1982 and from a couple of years a renewed interest has been pointed out by various authors¹²⁵⁻¹²⁸. Indeed, ferroelectric PVDF and its copolymers are the most interesting dielectric polymers due to the strong polarization originating from C-F bonds and the spontaneous orientation of dipoles in the crystalline phases^{63b}). For example, poly(VDF-co-CTFE) copolymer has a dielectric permittivity of 13¹²⁷.

A high electromechanical response was noted in poly(VDF-co-CTFE) copolymers containing 9 and 12 mol.% CTFE¹²⁹. That composed of 12 mol. % showed an electrostrictive strain response of more than 15 %. Comparing with other PVDF-based electroactive polymers (EAPs), the poly(VDF-co-CTFE) copolymer exhibits a higher strain response, but requires a higher driving electric field. Advantageously, that copolymer is less expensive and commercially available.

Poly(VDF-co-CTFE) copolymers based nanocomposites¹³⁰ were prepared by mixing that copolymer with carbon nanotubes (CNTs) or C₆₀ using solution cast method. The volume fraction of the CNT or C₆₀ was varying from 0.1 % to 1.0 %. The influence of CNT and C₆₀ on the crystallization behavior of poly(VDF-co-CTFE) copolymers was determined by XRD and DSC, and the authors showed that the CNTs or C₆₀ increase the β -phase and the crystallinity.

To enhance the dielectric properties of poly(VDF-co-CTFE) copolymers, various teams have selectively reduced the chlorine atom of CTFE units (first pioneered by Cais and Kometani¹³¹ in 1984, then in collaboration with Lovinger's group¹³², and it has been recently revisited by Lu *et al.*¹²⁶ to lead to poly(VDF-ter-CTFE-ter-TrFE) terpolymers (Scheme 6).

INSERT SCHEME 6

This last team¹²⁶ nicely characterized the microstructures of these terpolymers by ¹⁹F NMR, and they noted head-to-head VDF-TrFE diads in these "reduced" poly(VDF-co-CTFE) copolymers in contrast to head-to-tail VDF-TrFE diads produced from direct radical copolymerization of VDF with TrFE¹²⁸. Although that strategy to get poly(VDF-co-CTFE)

copolymer required one more step than the direct radical copolymerization of VDF with TrFE (see section 3.2.2), it has the advantage not to use hazardous TrFE (dangerous in transport and storage)¹³³.

Lu *et al.*¹²⁶ also noted that the ferroelectric fluoropolymers exhibit high dielectric constants. Tuning the structure of the copolymers enabled these American authors to establish the “polymer structure-thermal and dielectric properties” correlation which provided insights into the factors governing the responses in these organic electroactive materials. Actually, 47 samples of poly(VDF-ter-TrFE-ter-CTFE) terpolymers were synthesized and led to a wide range of materials having various Curie temperatures¹²⁶ (ranging from 22 to 106 °C while that of PVDF is 197 °C⁷⁰ or 195-197 °C⁷¹) and room temperature dielectric constants varying from 11 to 50 at 1 kHz. Indeed, high RT dielectric constant of 50 and a low dielectric loss ($\text{tg}\delta < 0.05$)¹²⁶ were reached for poly(VDF-ter-TrFE-ter-CTFE) terpolymer containing 78.8, 7.2, and 14.0 mol. %, respectively, and such values are higher than those of the terpolymers prepared by direct radical terpolymerization of VDF with CTFE and TrFE¹³⁴ (for which the dielectrical constant is 37.5¹³⁵).

The same American team¹³⁶ also investigated the direct radical terpolymerization of VDF with CTFE and TrFE and established the relationship between the composition of these terpolymers and the dielectric permittivity. They noted that for the same VDF content in the terpolymer, the higher the TrFE content, the higher the T_m and the lower the dielectric permittivity. Indeed, for a large energy storage capacity, both high dielectric permittivity and electrical breakdown strength are required. The same group could assess the permittivity of poly(VDF-ter-CTFE-ter-TrFE) terpolymers of 50 (measured at 1 kHz and at ambient T)¹³⁷.

In addition, Wang's team¹³⁹ has found that these terpolymers exhibit high electric energy density and can be used as potential ferroelectric capacitors with fast discharge-speed and high efficiency.

An original synthetic strategy for a similar application was also used by Chung's group^{119,138} who also investigated the controlled radical copolymerization of VDF with CTFE (and $\text{F}_2\text{C}=\text{CF}-\text{R}-\text{Si}(\text{OR})_3$) at room temperature in the presence of borane/oxygen system. In fact, the borinate generated *in situ* enabled to control that radical copolymerization (and more details are given in section 3.3.5). The obtained poly(VDF-co-CTFE) copolymers reached molecular weights greater than 20,000 $\text{g}\cdot\text{mol}^{-1}$ with narrow molecular weight-distributions and always showed a CTFE molar percentage higher than that of the feed.

From the same syntheses, Zhang and Chung¹²⁸ also carried out the selective reduction of chlorine atoms in CTFE units leading to original poly(VDF-ter-TrFE-ter-CTFE) terpolymers.

The consecutive VDF units provide strong polarization and the randomly distributed TrFE units (cocrystallizable with VDF units) direct the VDF sequence to all-trans (polar) conformation. In addition, the small amounts of bulky chlorine atoms in CTFE units serve as the kinks to reduce the crystalline size without significantly reducing the overall crystallinity (Scheme 7).

INSERT SCHEME 7

Hence, these poly(VDF-ter-TrFE-ter-CTFE) terpolymers exhibit potential ferroelectric properties such as diffuse phase transition, high dielectric constant at ambient temperature (the highest RT dielectric constant of 60 at 1 kHz for a terpolymer composed of 65.5 mol.% of VDF, 26.7 mol.% of TrFE, and 7.7 mol.% of CTFE, at the Curie temperature of 20-40 °C¹²⁸ compared to poly(VDF-co-CTFE) copolymers (see Figure 13), dielectric relaxation (large frequency dependence), for potential high pulsed capacitors with high energy density (releasing higher than 13 J.cm⁻³), low energy loss, and also no remanent polarization at zero electric field. The authors noted similar bulky CTFE effect in these terpolymers with the decreasing of the melting and Curie temperatures (down to 18.8 °C)¹³⁶.

INSERT FIGURE 13

From these controlled structures and molecular weight-poly(VDF-co-CTFE) copolymers, the same team showed another interesting application: fuel cell membrane¹²⁸, two types of which are presented hereafter.

The first type deals with the poly(VDF-co-CTFE) copolymer/Nafion[®]/inorganic fillers blend for which the highest conductivity was 25 mS.cm⁻¹ at 120 °C for 70 % relative humidity (RH) when H₃OZr₂(PO₄)₃ particles were used in 20 % (the Nafion[®] wt. content was 60 %). This is an interesting value since it is known that perfluorosulfonic acid polymers (e.g., Nafion[®]-type) lose their electrochemical performances (including the conductivity) when the temperature is higher than 85 °C at relative humidity (RH) < 100 %.

The second family involving first a similar methodology to obtain poly(VDF-ter-CTFE-ter-M) terpolymers precursors (Scheme 8) did not contain any Nafion[®].

INSERT SCHEME 8

Indeed, the sulfonic acid functions were added from a straightforward reaction [*via* sulfonated silicon dioxide or 2-(4-sulfonic phenyl) ethyl triethoxysilane, CSPETMS].

In certain conditions, the borinate end-group could be modified into a triethoxysilane end-group that leads to a tris(trialkoxysilane) poly(VDF-co-CTFE) copolymer able to react with CSPETMS *via* hydrolysis and condensation¹³⁸. After hydrolysis of SO₂Cl into sulfonic acid group, composite membranes were produced as illustrated by Scheme 9.

INSERT SCHEME 9

Satisfactory membrane conductivities (the ionic exchange capacity was 2.25 mmol.g⁻¹) were obtained (Figure 14)¹³⁸.

INSERT FIGURE 14

In addition, termination by radical coupling led to telechelic (or α,ω -difunctional PVDF) bis(trialkoxysilane). These original formed chain end functionalized fluoropolymers are effective surfactants⁷⁸ which showed a high interfacial activity in the exfoliated F-polymer/clay nanocomposite. The trialkoxysilane is able to anchor the polymeric chain to the clay interface while the hydrolytic polymer exfoliated the clay layer structure⁷⁸.

A different application related to very large electro-optic effect has been observed in relaxor ferroelectric poly(VDF-ter-TrFE-ter-CTFE) terpolymer¹⁴⁰. By adding a small amount of zinc sulfide (ZnS) nanoparticles, the refractive index of the nanocomposites can be tuned between about 1.4 and 1.5 while retaining large electro-optic effect and high transparency¹⁴⁰. Tunable long-period fiber gratings have been fabricated with the nanocomposite as the second cladding, and over 50 nm of resonant wavelength shift has been achieved under a change of electric field of 30 V. μm^{-1} , which is much larger than other reported E-O tuning ranges. This corresponds to a pure refractive index change of the nanocomposite of $\Delta n/n \sim 0.4\%$.

Another interesting optical application involving original thermoplastic elastomers was achieved by the Daikin Company¹⁴¹ from the iodine transfer copolymerization of VDF and CTFE in the presence of IC₄F₈I as the chain transfer agent. This has led to I-poly(VDF-co-CTFE)-I (Scheme 10) where the mol. % of VDF and CTFE were 55 and 45, respectively, as elastomeric block, the T_g value of which was -7 °C. This soft telechelic diiodide was able to reinitiate the radical copolymerization of ethylene (E) and CTFE (or E and tetrafluoroethylene). Original triblock Hard-Soft-Hard thermoplastic elastomers (the melting

points of the hard blocks containing either poly(E-alt-CTFE) or poly(E-alt-TFE) copolymers were 247 °C or 252 °C, respectively, Scheme 10) were produced for artificial lenses¹⁴¹.

INSERT SCHEME 10

Moreover, another interesting strategy to synthesize TPEs lies on a macroinitiator terpolymer (MacroPerCa) based on VDF, CTFE and on a peroxide-functional allyl monomer (TBPAC), subsequently grafted to PVDF to form a tough, flexible graft thermoplastic material, marketed by the Central Glass Company under the Cefral[®] trademark¹⁴² (Scheme 11).

INSERT SCHEME 11

In conclusion, poly(VDF-co-CTFE) copolymers have found valuable applications as nanocomposites, fuel cell membranes, surfactants, optical devices, capacitors and electroactive polymers or actuators (thanks to their piezoelectrical properties), and thermoplastic elastomers. Indeed, the piezo- or pyroelectric properties have been enhanced when a chlorine atom was selectively reduced, hence leading to original and very interesting poly(VDF-ter-CTFE-ter-TrFE) terpolymers. Further relevant electric properties are also shown in the section below from copolymers based on VDF and trifluoroethylene.

3.2.2. Poly(VDF-co-trifluoroethylene) Copolymers

VDF can copolymerize in all proportions with trifluoroethylene (TrFE)¹⁴³⁻¹⁴⁶ leading to random semi-crystalline thermoplastic copolymers, whatever the composition in contrast to poly(VDF-co-CTFE) and poly(VDF-co-HFP) copolymers. Nowadays, only poly(VDF-co-TrFE) copolymers containing a TrFE amount ranging from 17 to 50 mol. % have a slight commercial development limited to few tons per year.

Their microstructures were characterized by ¹⁹F nuclear magnetic resonance (NMR) spectroscopy for the first time in 1979 by Yagi and Tatamoto¹⁴³, then reviewed by Harris *et al.*^{45d} who, reported an extensive survey on their structure and morphology, and more recently, ¹⁹F MAS and ¹H-¹⁹F CP/MAS NMR spectra of poly(VDF-co-TrFE) copolymer containing 75 mol.% of VDF¹⁴⁴ (showing that the VDF-TrFE head-to-tail sequence is the most stable part in the copolymeric chain). At low temperature, the structural change between the crystalline forms with increasing TrFE content is detected clearly. At room temperature, the morphology of VDF-rich copolymers is readily analyzed, two components having the same ¹H and ¹⁹F ratios. On the other hand, below 70 mol. % VDF, the two components have

different ^1H and ^{19}F ratios, which implies segregation between TrFE-rich and VDF-rich sequences^{45d}.

In their very interesting chapter, Harris *et al.*^{45d} reported the microstructure of a poly(VDF-co-TFE) copolymer of 71:29 composition by ^{19}F NMR. They showed that there is 5 mol.% of diads in the oligo(TFE) blocks and 2.5 mol.% of head-to-head defects in the oligo(VDF) blocks.

Actualt, Poly(VDF-co-TrFE) copolymer of composition 70:30 has a Tg of 0 °C.

The above Japanese pioneers¹⁴³ assessed the reactivity ratios of both comonomers, as follows: $r_{\text{VDF}} = 0.70$ and $r_{\text{TrFE}} = 0.50$ at 22 °C, from solution copolymerizations.

Although expensive because of the price and hazards of TrFE¹³³, these copolymers have found applications in various fields thanks to their piezo-, ferro- and pyroelectrical properties¹⁴⁵ since the incorporation of TrFE into PVDF induces the appearance of a ferroelectric-to-paraelectric (F-P) phase transition below the melting temperature of the polymer crystals¹⁴⁶. This F-P phase transition (called Curie transition) is associated to the crystalline phase change from polar (β) phase to nonpolar (α) phase and the copolymer conformation changes from all-trans to trans-gauche^{146c}.

As expected, the Curie temperature (T_c) reduces with the increase of TrFE content in the PVDF chain. However, it reaches the lowest point (ca. 96 °C) after incorporating ca. 20 mol.% of TrFE units, which is a dramatic difference from that of the poly(VDF-co-TrFE) copolymers prepared by direct copolymerization for which the T_c value of similar copolymer composition is higher than 130 °C and continuously decreases to 65 °C for these copolymers before reaching a constant value^{146b-d}.

Ferroelectric poly(VDF-co-TrFE) copolymers were inflated into three-dimensional periodic opal lattices with nanosilica opal diameter (180-300 nm) to form periodic composite structure. Further, this method was efficient to prepare inverse copolymer opal where the copolymer can nearly completely fill the voids in the silica opal¹⁴⁷.

In addition, Ohigashi *et al.*¹⁴⁸ pioneered that the remanent polarization of poly(VDF-co-TrFE) copolymers was 100 mC.m⁻², while Fang *et al.*¹⁴⁹ reported an intriguing phenomenon of polarization enhancement for poly(VDF-co-TrFE) 75/25 mol % copolymer films under cyclic electric field. The copolymer film, initially subjected to electric cycling at a comparatively low field magnitude, led to an increase of the remanent polarization with the field cycles. These authors also examined the morphology and microstructure changes during the electric cycling. They suggested that the polymer chains in the interfacial layers between the

crystalline and amorphous regions gradually increase in the ordering degree and that contributes to the polarization enhancement during electric cycling.

However, these remanent polarization values seem lower than that of a VDF telomer¹⁵⁰ containing 14 or 17 units of VDF units (and thus a lower molecular weight than PVDF). Among the organic ferroelectrics, it has the largest reported remanent polarization. In addition, the piezoelectric coefficient of oligo(VDF) was greater than that of poly(VDF-co-TrFE) copolymer. A film composed of that oligo(VDF) was thin and uniform and was evaluated as a prototype sensor device for medical tactile sensors.

As a matter of fact, the incorporation of a few percentage of CTFE (or $F_2C=CHCl$) units in the poly(VDF-co-CTFE) copolymers is very effective in altering the Curie temperature¹²⁵ and the activation energy of the ferro-paraelectric phase transition, without significant reduction of the overall crystallinity and dielectric constant.

Dielectric and electroactive strain behaviors of poly(VDF-ter-CTFE-ter-TrFE) terpolymers containing different CTFE contents from room temperature down to cryogenic temperatures have been investigated by Yu *et al.*¹⁵¹. The increase of the CTFE concentration has slightly shifted the temperature where the maximum dielectric constant occurs at lower temperature, whereas high electroactive strain (ca. 1 %) was noted for the compositions. Furthermore, high stress level was decreased at cryogenic temperatures hence leading to promising space technology applications.

In addition, Lu *et al.*^{126a} assessed the dielectric constant of the copolymers versus the content of both comonomers and showed a maximum value of 47 at 1 kHz at 25 °C (Figure 15), though the maximum remanent polarization attained with a poly(VDF-co-TFE) copolymer film containing 80 mol.% (the crystallinity of which was 50 %) was 3.0 mC.cm⁻².

INSERT FIGURE 15

As shown for PVDF, nanocomposites based on poly(VDF-co-TrFE) copolymer have got enhanced electrical properties of these ferroelectric copolymers thanks to polyaniline conductive nanofibers¹⁵². These polyaniline (PANI) nanofibers doped by protonic acids have a high dispersion stability in poly(VDF-co-TrFE) copolymer and lead to percolative nanocomposites. About a 50-fold raise in the dielectric constant of the ferroelectric polymer matrix has been observed. Percolation thresholds of the nanocomposites are relevant to doping levels of PANI nanofibers and can be as low as 2.9 wt. % for fully doped materials. The interface between the conductive nanofiber and the polymer matrix plays a crucial role in

the dielectric enhancement of the nanocomposites in the vicinity of the percolation threshold. Compared with other dopants, perfluorosulfonic acid resin is better at improving the performance of the nanofibers. Noteworthy, these nanocomposites can be utilized for potential applications as high energy density capacitors, thin-film transistors, and non-volatile ferroelectric memories.

In another topic, Poulsen *et al.*¹⁵³ succeeded in preparing Langmuir Blodgett films based on poly(VDF-co-TrFE) copolymers.

In conclusion, poly(VDF-co-TrFE) copolymers are semicrystalline whatever the compositions and have demonstrated exceptional dielectric properties which enable them to find interesting applications as capacitors, electroactive polymers or actuators, and nanocomposites.

3.2.3. Poly(VDF-co-Hexafluoropropylene) Copolymers

3.2.3.1. History and characteristics of poly(VDF-co-HFP) Copolymers

The first poly(VDF-co-HFP) copolymer was produced in 1957 by the DuPont de Nemours Company, a part of which became DuPont Dow Elastomers LLC (from the joint venture with Dow Chemicals and DuPont formed in 1996 and has been called DuPont Performance Elastomers since mid-2005) under Viton[®] trademark. These polymers have better thermal stability and inertness to chemicals and a lower swelling to oils and petroleum than the copolymers of TFE¹⁵⁴. Then, Fluorel[®] copolymers became available from 3M which have been called Dyneon since 1999. Poly(VDF-co-HFP) copolymers have also led to various kinds of products according to the content of hexafluoropropylene. At less than 15-19 mol. % of HFP, the resulting copolymers show thermoplastic properties^{3,5-8,155,156} (Figure 16), while those containing a higher HFP content behave as elastomers^{3,5-8,156}. Ajroldi *et al.*¹⁵⁷ have demonstrated that a composition of 20-21 mol. % HFP represents the best compromise between the requirements of a low T_g and a fully amorphous elastomer. On both academic and applied points of view, Apostolo *et al.*¹⁵⁸ carried out interesting investigations on the kinetics of emulsion copolymerization of VDF and HFP, monitoring all the parameters of the experimental conditions and using an appropriate model.

INSERT FIGURE 16

Thermoplastic poly(VDF-co-HFP) copolymers are currently produced by Arkema or Solvay under the Kynar[®] or Solef[®] tradenames, respectively, while elastomeric poly(VDF-co-HFP) copolymers are marketed by Daikin, DuPont Performance Elastomers, 3M/Dyneon, Solexis and the S.V. Lebedev Synthetic Rubber Institute (VNIISK) called Daief[®], Viton[®], Duneon[®] Copolymers, Tecnoflon[®], and Fluorelast[®], respectively. In addition, 3F in China and KCCE, Kirovochepetsk in Russia are presently producing these elastomers.

Ferguson^{45a)} pioneered the ¹⁹F NMR solution-state spectroscopy of poly(VDF-co-HFP) copolymers that was later deeply investigated by Pianca *et al.*¹⁵⁹. On the other hand, Harris *et al.*^{45d} supplied a very interesting ¹⁹F high resolution solid-state (magic angle spinning) spectra of a commercially available Viton[®] copolymer providing peak decomposition and structural assignment of that copolymer and also supplying relaxation time associated with all the resonance peaks.

In addition, Moggi's group¹⁶⁰ correlated the microstructures of these poly(VDF-co-HFP) copolymers with their T_gs and melting temperatures, and their crystallinity (assessed by DSC and by X-ray diffraction, respectively). They observed that the presence of a few amount of HFP in these poly(VDF-co-HFP) copolymers did not affect the polymorphism of PVDF. Later on, Tarascon *et al.*¹⁶¹ revisited the thermal behaviors of various copolymers containing different contents of VDF and HFP, showing, as expected that the higher the content of HFP in thermoplastic, the lower the melting point of the copolymer (Figure 17).

Furthermore, an interesting comparison of the T_gs of fluoroelastomers containing VDF was realized by Van Cleef¹¹ showing that their T_gs could not be lower than -29 °C.

INSERT FIGURE 17

Interestingly, DeSimone *et al.*^{39,40,156}, and Howdle's team⁴¹ carried out original radical copolymerizations of VDF and HFP in supercritical CO₂ medium which enabled to solubilize the resulting poly(VDF-co-HFP) copolymers. According to the VDF content, these copolymers exhibit either thermoplastic or elastomeric morphologies (Figure 16).

Even more recently, Asandei *et al.*¹⁶² investigated the UV irradiated-copolymerization of VDF with HFP, simultaneously initiated by *tert*-butyl peroxide (DTBP) and 2,5-bis(*tert*-butylperoxy)-2,5-dimethylhexane (BTBDMH). For a given total reaction time, a continuous increase in conversion was observed with increasing irradiation time and faster rates were observed for tetrafunctional BTBDMH than from difunctional DTBP. The molecular weights

and polydispersity indices remained relatively constant. The authors claimed that UV irradiation was essential for the generation of initiator derived radicals at room temperature but does not induce pure photopolymerization in the absence of the initiator¹⁶². Further work was also investigated under various temperatures ranging from 25 to 90 °C in different solvents. While many conventional thermal or redox systems failed to initiate in this temperature range, oxygen centered radicals initiated the copolymerization even at room temperature especially under UV irradiation. The trend in initiator efficiency (tert-Bu peroxybenzoate < dicumyl peroxide < di-tert-Bu peroxide) parallels the increase in the nucleophilicity of these radicals. The authors also observed that the solvent effect (acetonitrile = DMSO >> trifluorotoluene) correlates with the solvent polarity^{162b}.

3.2.3.2 *Properties & applications*

Poly(VDF-co-HFP) copolymers can be either thermoplastic or elastomers according to the HFP content, and its crosslinking enables to produce various or items bearing hostile environment⁶⁻⁹ such as gaskets, O-rings, diaphragms for aerospace, automotive, or for oil industries. Exotic copolymers also exhibit certain dielectric properties, yet lower than those of poly(VDF-co-TrFE) copolymers. For example, similarly as above, the room temperature terpolymerization of VDF with HFP and methacryloxypropylheptacyclo-pentyl-T8-silsesquioxane (MP-POSS), readily initiated by DTBP under UV radiation, led to polymers having potential applications as high dielectrical constants materials^{162c}.

The effect of introducing a multilayer microstructure on the dielectric properties of polymer materials has been evaluated in 32- and 256-layer films with alternating polycarbonate (PC) and poly(VDF-co-HFP) layers¹⁶³. The permittivity, dielectric loss, dielectric strength, and energy density were measured as a function of the relative PC/copolymer volume concentrations. The permittivity follows an effective medium model while the dielectric strength was typically higher than that predicted by a volume fraction based weighted average of the components. Energy densities as high as approximately 14 J.cm³, about 60 % greater than that of the component polymers, are measured for PC/copolmer films in 50/50 wt. %.

Other areas such as blends have been explored, and Wang and Tang¹⁶⁴ blended poly(VDF-co-HFP) copolymers with poly(vinyl pyridine). They evidenced their miscibility from the assessment of a unique T_g for each composition. In addition, poly(VDF-co-HFP) copolymers/ionomer blends have led to deeper investigations, summarized below.

3.2.3.3. *Poly(VDF-co-HFP) copolymers involved in Energy-Related Applications*

In fact, poly(VDF-co-HFP) copolymers have also found out various applications in the Energy area (membranes for fuel cells, rechargeable lithium ion batteries, dye-sensitized solar cells). Non-exhaustive examples are listed below.

a) Polymer Electrolyte Membrane Fuel Cell (PEMFC)

The advantage to involve these copolymers in fuel cell membranes is mainly because the high molecular weight-poly(VDF-co-HFP) copolymers that supply the mechanical strength and, as mentioned above for PVDF, can also be blended with various proton conducting systems. Fortunately, these membranes strongly resist to acidic media, in which the poly(VDF-co-HFP) copolymers are stable, in contrast to alkaline ones where these copolymers undergo dehydrofluorination¹⁶⁵.

Song *et al.*¹⁶⁶ realized membranes made of Nafion[®] and poly(VDF-co-HFP) copolymers, both these components showing a high miscibility up to 60 % of Nafion[®] fraction. Advantageously, the hydrophobic VDF containing copolymers reduced the water uptake of the resulting membranes, though the conductivity values were lower than that of Nafion[®]115. MAEs were prepared from these membranes (35 μm thick) also doped with sulfuric acid and hot pressed between catalyzed carbon paper ELAT electrodes. A 25 cm^2 single cell was prepared and delivered a maximum power of 440 $\text{mW}\cdot\text{cm}^{-2}$ at 900 $\text{mA}\cdot\text{cm}^{-2}$ under H_2/O_2 flows. It was comparable to the performance of Nafion[®]115 under the same operating conditions.

Cho *et al.*¹⁶⁷ elaborated membranes from miscible poly(VDF-co-HFP) copolymer (containing a 15 mol. % HFP and $M_n=380,000 \text{ g}\cdot\text{mol}^{-1}$) / Nafion[®] 117 blends. A pretreated Nafion[®] 117 membrane was immersed into a poly(VDF-co-HFP) copolymer/Nafion[®] solution in DMF to coat it with that poly(VDF-co-HFP) layer (ca. 1 μm). Both objectives were: i) to enhance the electrode / membrane compatibility of a DMFC, and ii) to reduce the methanol crossover from the anode to the cathode. Interestingly, the coated Nafion[®] exhibited better performances in DMFC than the uncoated one, as evidenced by the polarization curves (Figure 18).

INSERT FIGURE 18

Niepceron *et al.*¹⁶⁸ elaborated composite membranes showing potential applications as PEMFC, composed of a poly(VDF-co-HFP) copolymer (16 wt. % HFP, molecular weight of 350,000 $\text{g}\cdot\text{mol}^{-1}$ and $T_m = 135 \text{ }^\circ\text{C}$) embedded polystyrene sulfonic acid-grafted silica particles (7 nm-diameter and 390 $\text{m}^2\cdot\text{g}^{-1}$ of specific surface). These membranes were prepared in three

steps (Scheme 12): i) the condensation of trimethoxysilyl chloromethyl styryl onto the surface of the silicaparticles *via* the hydroxyl groups leading to original particles containing benzyl chloride end-groups; ii) these latters could initiate the atom transfer radical polymerization (ATRP) of sodium styrene sulfonate *via* the “grafting from” procedure yielding hydrophobic polymer (average particle size of 370 nm, and molecular weight of 54,000 g.mol⁻¹, PDI > 1.5, and ionic exchange capacity of 3.0 ± 0.4 meq.g⁻¹); iii) the resulting membranes were either extruded or cast to favor a homogeneous dispersion of the particles in the fluorinated matrix which brought the mechanical properties. According to the process, the authors observed various morphologies of the membranes, from particle aggregates to co-continuous domains, by confocal fluorescence microscopy. They noted that the percolation threshold was achieved for ca. 30 wt. % loading. Niepceon *et al.*¹⁶⁸ showed that the ohmic resistance *versus* the thickness of the composite membranes was not a linear relationship but sedimentation (inhomogeneous dispersed particles) occurred from 60 µm and the polarization curve gave the best results for a membrane of 30 µm. Finally, a satisfactory balance between the proton conductivity ($\sigma = 95 \pm 6 \text{ mS.cm}^{-1}$ at 20 °C) and reasonable water uptakes was achieved from , a loading of 40 to 60 wt. %.

INSERT SCHEME 12

On the other hand, Scrosati’s team¹⁶⁹ incorporated original ionic liquids (by neutralizing tertiary amines with N,N-bis(trifluoromethanesulfonyl)imide) into poly(VDF-co-HFP) copolymer matrix for high temperature polymer electrolyte fuel cell membrane endowed with an ionic conductivity of 10⁻² S.cm⁻¹ at 140 °C.

b) Rechargeable lithium-ion Batteries

Another type claimed by various authors^{75,161,170-172} concerns the interesting properties of poly(VDF-co-HFP) copolymers as a host for liquid electrolytes for applications in rechargeable lithium batteries and several examples are suggested hereafter. There is an increasing interest and use for ion lithium batteries as evidenced by the linear evolution of the production volume of Li-ion cells *versus* years (Figure 19). In 1975, Feuillade and Perche¹⁷³ pioneered the use of several gelled copolymer electrolytes based on commercially available matrices such as polyacrylonitrile, polyvinyl butyral, polyvinylpyrrolone, and poly(VDF-co-HFP) copolymers as electrolytes of Li/CuS batteries. On the other hand, as the liquid

electrolyte uptake sometimes decreases the mechanical strength of poly(VDF-co-HFP) gelled electrolyte, Wang *et al.*¹⁷⁴ reported the use of a microporous polyolefin to improve the mechanical properties.

INSERT FIGURE 19

This new strategy to increase the ionic conductivity of polymeric gel electrolytes has been proposed, either by embedding the liquid electrolyte in the pores¹⁷⁵ or to insert nanoparticles¹⁷⁶ or ionic liquid¹⁷⁷. Indeed, Tarascon's team^{161,171} showed that poly(VDF-co-HFP) copolymers can uptake more electrolyte solutions than PVDF because of their lower degree of crystallinity. Interestingly, the group of Watanabe^{170b} observed lower conductivity values of PVDF than poly(VDF-co-HFP) copolymer containing 12 mol. % HFP and 6 % head-to-head defects (i.e., -CH₂CF₂-CF₂CH₂- diads) of chaining *versus* the electrolyte uptake (Figure 20).

Further data on the swelling behavior of copolymers based on VDF, their kinetics, safety concerns, electrochemical properties of VDF based-separators and batteries performances have been well documented by Sanchez *et al.*⁷⁵.

More recent investigations¹⁷⁶ on poly(VDF-co-HFP)/silica composites have shown the beneficial effect of SiO₂ i) in providing better mechanical properties to the conducting membranes and ii) in increasing the porosity of the dry copolymers. Consequently, the volume of the liquid phase in the produced gel becomes higher and the conductivity increases. More recently, Ye *et al.*¹⁷⁷ used 1-methyl-3-propyl-pyrrolidinium bis(trifluoromethanesulfonyl)imide (P₁₃TFSI) as ionic liquids and obtained dimensionally stable, elastic, flexible, ion-volatile polymer gel electrolytes with high electrochemical stabilities, high ionic conductivities and other desirable properties. They were synthesized by dissolving Li imide salt (LiTFSI) in P₁₃TFSI ionic liquid and then mixing the electrolyte solution with poly(VDF-co-HFP) copolymer.

INSERT FIGURE 20

In addition, to improve the discharge capacity in lithium ion microbatteries, a thick-film cathode was fabricated by a screen printing using LiCoO₂ pastes¹⁷⁸. An all-solid-state microbattery could be assembled using sputtered LiPON electrolyte, an evaporated Li anode,

and printed LiCoO₂ cathode films without delamination or electrical problems. This problem was improved by using a poly(VDF-co-HFP) gel electrolyte, which enhanced the contact area and adhesion force between the cathode and the electrolyte, and could increase the discharge capacity from 7 $\mu\text{Ah.cm}^{-2}$ to 164 $\mu\text{Ah.cm}^{-2}$ ($\approx 110 \text{ mAh.g}^{-1}$). Interestingly, the authors claimed that the cell can be fabricated in a leakage-free process, hence resolving safety problems for a microbattery.

Another process to improve the efficiency of the Lithium ion batteries in which poly(VDF-co-HFP) copolymers were used as the separator and the binder for electrodes was achieved by crosslinking these copolymers in the presence of an aliphatic diamine as crosslinking agent¹⁷⁹. Such a strategy offered mechanically resistant membranes with improved thermal and chemical stabilities and made the binder insoluble in the electrolyte. Hence, the resulting secondary batteries¹⁷⁹ showed reversible capacity retention higher than 80 % even after 50 cycles.

An interesting approach to obtain an original homogenous blend of polyethylene oxide (PEO) and poly(VDF-co-HFP) copolymer was proposed by Cheng *et al.*¹⁸⁰ who synthesized a semi-IPN by dissolving a poly(VDF-co-HFP) copolymer with an α,ω -dimethacrylate PEO, PEODM, followed by a free-radical copolymerization. The solvent evaporation generated some porosity. The resulting membrane was swollen by 1M LiPF₆ in ethylene carbonate-dimethylcarbonate and the liquid uptake decreased with the content of PEO network, though the conductivities of the swollen membranes reached 1.5 mS.cm^{-1} at 25 °C.

Such a strategy was also investigated by Korean authors¹⁸¹ who noted an enhancement of the thermal stability of poly(VDF-co-HFP) copolymer gel polymer electrolyte (GPE) by crosslinking with α,ω -diacrylate PEO. The resulting semi-IPN structure reduced the crystallization of the fluorinated copolymer and had better affinity with organic liquid electrolyte in a cell composed of LiCoO₂/GPE/Li foil.

Commercially available Nafion[®] 117 membrane was lithiated¹⁸² (after classical treatment, the Nafion[®] grains were immersed into 1 M LiOH solution) and mixed with poly(VDF-co-HFP) copolymer containing 12 wt. % of HFP and fumed nanosilica (12 nm). Afterwards, the mixtures were cast as polymer electrolyte films. The ionic conductivities that rose rapidly to $10^{-4} \text{ S.cm}^{-1}$ depend on the Li⁺ ion content and on the addition of SiO₂. Wang *et al.*¹⁸² suggested that the high conductivity (Figure 21) can be attributed to these nanoparticles which have a drastic influence on the morphology.

INSERT FIGURE 21

In addition, these authors also proposed a model (Figure 22) suggesting the interaction between the ionic groups and the polymer backbone in the Nafion[®]-Li / poly(VDF-co-HFP) copolymer blend electrolyte.

INSERT FIGURE 22

c) Solar Cells

Another original topic related on energy-related application concerns dye-sensitized solar cells (DSSC)¹⁸³. Microporous polymer electrolytes based on poly(VDF-co-HFP) hybrid with different amounts of either silica nanoparticles (to solidify 3-methoxypropionitrile based liquid electrolytes)^{183a} or TiO₂ nanoparticles^{183b} were prepared. The microporous polymer electrolyte with TiO₂ nanoparticles modification exhibited better ionic conductivity compared with the original poly(VDF-co-HFP) copolymer electrolyte with an optimal ionic conductivity of 0.8 mS.cm⁻¹ obtained with 30 wt % TiO₂ nanoparticles modification. When assembled with the 30 wt % TiO₂ nanoparticles modified quasi-solid-state electrolyte, the dye-sensitized TiO₂ nanocrystalline solar cell exhibited the light to electricity conversion efficiency of 2.465 % at light intensity of 42.6 mW.cm⁻², much better than the performance of original poly(VDF-co-HFP) microporous polymer electrolyte DSSC^{183b}.

In conclusion, a wide range of poly(VDF-co-HFP) copolymers are produced, and, according to their HFP percentages, can behave as thermoplastics, elastomers or thermoplastic elastomers. They exhibit a high thermostability and when they are crosslinked show a high insolubility, enhanced mechanical properties, and are resistant to oils, fuels, chemicals, hence they can bear a hostile environment. However, the glass transition temperatures of these crosslinked copolymers is a bit high to find out potential applications at low temperatures or in cryogenic conditions. Nevertheless, these copolymers have already been involved in various applications, and in the last five years an increasing academic and industrial research required them for various items in the field of Energy (PEMFCs, Li ion batteries, solar cells, etc...).

3.2.3.4. Poly(VDF-ter-HFP-ter-comonomer) Terpolymers

Various examples of poly(VDF-ter-HFP-ter-comonomer) terpolymers are given hereafter, the most important in volume and applications is when the comonomer is tetrafluoroethylene

(TFE). According to their contents in VDF, HFP and TFE, poly(VDF-ter-TFE-ter-HFP) terpolymers can be elastomers or thermoplastics or thermoplastic elastomers (marketed by DuPont Performance Elastomers, Solvay Solexis, 3M/Dyneon, or Daikin, under the Viton[®] B, Tecnoflon[®], THV[®] (or Dyneon[®] terpolymers), or Dai-el[®] trademarks, respectively (Table 1). Quasi-exhaustive interesting reviews have been proposed by Hull *et al.*¹¹⁵ or by Moore⁵.

Elastomeric terpolymers of VDF, TFE and HFP provide gum stocks for high performance fluoroelastomers while for various amounts of these three fluorolefins, thermoplastic elastomers can be produced, well-reported by Hull *et al.*¹¹⁵. Indeed, according to the respective amounts of monomers, the elastomeric behavior [the region of the triangle (the summits of which are VDF, HFP and TFE) encompasses a composition of 20 to 70 % of VDF; 20 to 60 % of HFP and 0 up to 40 % of TFE]⁶⁻⁸ may fall into a thermoplastic elastomeric one (composition of 15-20 or 70-80 of VDF ; 13-25 or 80-85 of HFP and 15-30 or 80-85 % of TFE) nicely explained by Logothesis⁶ or Hull *et al.*¹¹⁵ and also by the 3M company¹⁸⁴. Melting points of the thermoplastics range between 170 and 220 °C. For a structural point of view, it is required that the microstructure of the elastomers contains about one HFP unit for every 2-4 of the other monomer units to prevent any crystallization of the terpolymer and to insure an amorphous macromolecule. Although no adjacent HFP units were found in the microstructure (its reactivity ratio worths 0), more recent telomerization of HFP gives evidence to the presence of two consecutive HFP units when the reaction was carried out at higher temperatures¹⁸⁵ in the presence of α,ω -diiodoperfluorobutane. Carefully ¹⁹F NMR spectroscopy of these poly(VDF-ter-HFP-ter-TFE) terpolymers was achieved by Dec *et al.*¹⁸⁶.

THV[®] Medical devices are coated with terpolymers of tetrafluoroethylene, hexafluoropropylene, and vinylidene fluoride (THV[®])¹⁸⁷. The mole fractions of tetrafluoroethylene, HFP and VDF and VDF can be in the ranges from about 0.005 to about 0.85, 0.005-0.85, and in the 0.005-0.990 range, respectively. Elastomers or TPEs have found applications as fuel hoses^{5,115}. The THV[®] coating on the implantable medical devices are advantageously biocompatible¹⁸⁷.

Basic researches have also been published from these terpolymers. A first recent example, reported by Emmons *et al.*¹⁸⁸ deals with the high-pressure Raman spectroscopy and X-ray diffraction of THV[®] 500, for which changes in interatomic spacing and shifts of the vibrational bands were compared to those of PTFE, showing the effects of copolymerization and reduced crystallinity.

A second example, reported by two German laboratories¹⁸⁹, displays designed terpolymerizations of VDF with HFP and TFE to produce various samples of two different morphologies: straight linear topology or model poly(VDF-ter-TFE-ter-HFP) terpolymers with an interesting controlled amount of long chain branching (LCB). The linear THV[®] terpolymers' absolute molar mass distributions were assessed by size exclusion chromatography coupled with multiangle light scattering^{189a}. The presence of the LCB was evidenced by the reduced radius of gyration in the high molar mass region^{188a} and by dynamic-mechanical measurements^{189b}. These branched terpolymers behaved in a complex thermorheological way. Indeed, their zero-shear rate viscosities were significantly higher than those of linear terpolymers with equivalent molecular weights^{189b}. Based on further rheological properties in solution and in the molten state, the authors demonstrated that the linear behavior of the melts can favorably be used to get an insight into the molecular architecture of THV[®] terpolymers.

Several termonomers other than tetrafluoroethylene (TFE) have also been incorporated successfully to lead to poly(VDF-ter-HFP-ter-M) terpolymers where M represents CTFE¹⁹⁰, α -trifluoromethacrylic acid¹⁹¹, hexafluoroacetone¹⁹², $O=C(R_F)_2$ ¹⁹³, $F_2C=CFO-Ar-X$ (where X stands for Br ¹⁹⁴ or SO_2Cl ¹⁹⁵) and methacryloxypropylheptacyclo-pentyl-T8-silsesquioxane (MP-POSS)^{162c} as reported in section 3.2.3.2.

Lannuzel *et al.*¹⁹⁰ inserted CTFE as a termonomer in the suspension radical terpolymerization of VDF with HFP which led to a thermoplastic containing 95.0 mol. % of VDF, 1.6 mol. % of CTFE and 3.4 mol. % of HFP having a melt flow index of 2.26 (21.6 kg) and a melting temperature (T_m) of 141 °C.

The other termonomers behave as HFP or PMVE: they donot homopolymerize under radical conditions copolymerize with HFP (except $F_2C=CFO-Ar-X$)^{194,195} but terpolymerize in the presence of VDF and HFP. This is also the behavior of $Y_2C=CYSF_5$ ¹⁹⁶ reported in the terpolymerization of VDF and HFP with pentafluorosulfanyl derivatives that led to original SF_5 -containing materials. The molar masses and the thermal properties were also assessed¹⁹⁷. The overall structures of the obtained copolymers and the increasing order of reactivity in terpolymerization with VDF and HFP (though the radical copolymerization with VDF was smoother than those involving PMVE, HFP and PPVE) were as in Scheme 13.

INSERT SCHEME 13

3.2.4. Poly(VDF-co-tetrafluoroethylene) copolymers

Poly(VDF-co-TFE) copolymers are statistic, as most VDF-containing copolymers.

Radical copolymerizations of VDF and tetrafluoroethylene (TFE) have been carried out in emulsion¹⁹⁸⁻²⁰¹ or under “exotic” plasma initiation²⁰². Several kinetics of radical copolymerization^{200, 201} have been investigated leading to the reactivity ratios of both comonomers $r_{\text{VDF}} = 0.11$ ²⁰⁰ or 0.32 ²⁰¹ and $r_{\text{TFE}} = 1.06$ ²⁰⁰ or 0.28 ²⁰¹ at 25 °C (Table 2).

Deeper studies on their microstructures from ¹⁹F NMR spectroscopy have also been realized²⁰³ just like the mechanism of this copolymerization. Actually, a Russian team²⁰⁴ which pointed out chain transfer and chain termination of primary and growing macroradicals, along with branched structures linked to their compositions and structures).

Regarding the properties, poly(VDF-co-TFE) copolymers have received increasing attention since the first discovery reported by Lovinger²⁰⁵ in 1983 of these ferroelectric materials and the assessment of their Curie transitions. Lando and Doll²⁰⁶ noted that these copolymers were able to crystallize from the melt with the unit cell of the ferroelectric β phase, provided they contain at least 7 mol.% TFE. Piezoelectricity and pyroelectricity in poly(VDF-co-TFE) copolymers have been investigated by several authors²⁰⁷. Lovinger *et al.*²⁰⁸ synthesized poly(VDF-co-TFE) copolymers over a full compositional range and their crystalline structures have been studied at ambient temperature, as well as during heating to the melting point and subsequent cooling. The room-temperature structure changes from α -PVDF (for compositions with > 93 mol. % VDF) to β -PVDF (for 71-92 mol. % VDF), to β -PVDF and PTFE-like (for 35-71 mol. % VDF) and eventually to PTFE (for < 34 mol. % VDF). Between 72 and 82 mol.% VDF, discrete and reversible Curie transitions have been observed; the same type as these authors already noted in poly(VDF-co-TrFE) copolymers that exhibit the same kind of paraelectric structures. In addition, the authors observed that the ferroelectric-to-paraelectric transition increased linearly with the VDF content up to 81-82 mol. %, where it is aborted by melting.

The maximum remanent polarization attained for a poly(VDF-co-TFE) copolymer containing 80 mol. % VDF (the crystallinity of which was estimated by XRD to be 50 %) was 3.0 mC.cm^{-2} ^{45c}.

Various applications of copolymers based on VDF and TFE and even other comonomers (i.e. vinyl esters²⁰⁹) have been developed by Dupont Performance Elastomers²⁰⁹ which synthesized original elastomers based on VDF and TFE, while transparent films were obtained by the

Kureha Chemical Industry²¹⁰ ($\geq 85\%$ transparency to parallel light for 30- μm films). Further, terpolymers based on VDF, TFE and comonomers have also been synthesized and few examples involving ethylene, propylene, 3-ketofluoroglutaroyl halides, and perfluoromethyl vinyl ether (PMVE) are given hereafter. First, the suspension terpolymerization of VDF with TFE and ethylene (E), carried out by the same Japanese company, led to dielectric materials (dielectric constant ≥ 4.0 and dielectric loss ($\text{tg}\delta < 0.5\%$)) endowed with excellent heat resistance²¹¹.

In poly(VDF-ter-HFP-ter-TrFE) terpolymers, various authors^{6-8,10} claimed that, a HFP unit surrounded by two VDF units or by VDF and TFE units was shown to be a useful structure curable by dinucleophiles, since the $-\text{CF}_2\text{CF}(\text{CF}_3)\text{CH}_2\text{CF}_2-$ diad may be dehydrofluorinated, leading to a reactive inner double bond. This double bond was also created to enable the addition of amino compounds (according to a Michael reaction). Interestingly, an elegant strategy developed at the Asahi Glass Company²¹², to improve the well known Aflas[®] elastomers (based on alternating poly(TFE-alt-P) copolymer) dealt with the replacement of HFP by propylene (P) which made the resulting poly(VDF-ter-TFE-ter-P) terpolymers resistant to dehydrofluorination. This can be explained by the less electron-withdrawing CH_3 group than CF_3 , that contributes to a lower acidity of the adjacent methylene and methine functionality. As a result, this terpolymer has been crosslinked with difficulty in the presence of conventional nucleophilic cure systems²¹².

Such poly(VDF-ter-TFE-ter-P) elastomers have found valuable applications in lithium-ion batteries²¹³ after coupling the electrode particles and crosslinking which improves their mechanical properties. A stable specific capacity of ca. $800 \text{ mAh}\cdot\text{g}^{-1}$ was achieved. Yuan *et al.*^{200a} investigated the emulsion terpolymerization of VDF with TFE and perfluoromethyl vinyl ether (PMVE), and showed that the emulsion terpolymerization rate (R) depends on the stirring rate, on the concentrations of both the surfactant (S) and of the initiator (I), and on the total gaseous pressure (P), as follows:

$$R = 5.78 \times 10^{-3} S^{0.58} I^{0.4067} P^{1.540} \text{ at } 60^\circ\text{C}$$

This group has also brought valuable data on the microstructure of the terpolymers by ¹⁹F NMR and studied interesting kinetics of that terpolymerization^{200b}.

As for industrial topic, Viton GLT marketed by DuPont Performance Elastomers possesses remarkable properties has launched a terpolymer based on VDF, PMVE and traces of TFE. For similar applications, Daikin, 3M/Dyneon and Solvay Solexis have also developed Daiel[®], Dyneon[®], and Tecnoflon[®]PL, respectively (Table 1). In addition, Hung and Tang²⁰⁹

successfully incorporated PMVE and a vinyl ester (which could be further saponified) to produce original F-elastomers more recently.

Finally, the solvent terpolymerization of VDF with TFE and 3-ketotetrafluoroglutaroyl fluoride, initiated by perfluoropropionyl peroxide, was successfully achieved¹⁹³. The resulting terpolymers, showing high molecular weights (the intrinsic viscosity was 2.37 dL.g⁻¹), were pressed at 190 °C to lead to a strong, flexible, cold-drawable film that creased without cracking.

3.2.5. Poly(VDF-co-pentafluoropropene) copolymers

The main target to synthesize copolymers of VDF and 2-hydropentafluoropropene (PFP, CF₃CH=CF₂), produced by 3M²¹⁴ or Montedison²¹⁵ was to compete with poly(VDF-co-HFP) copolymers, leading to original fluoroelastomers. But their lower thermostability could not allow these materials to find effective development. Nevertheless, little basic research has been achieved²¹⁶: the kinetics of copolymerization enabled a Russian team to assess the reactivity ratios of both comonomers (Table 2) showing that VDF is more reactive than its pentafluorinated partner ($r_{\text{VDF}} = 9.0$ and $r_{\text{PFP}} = 0.06$ ²¹⁶). Indeed, quite a few fluorinated comonomers have been successfully used in radical copolymerization with PFP, such as CTFE, HFP, TFP, VDF and perfluoromethyl vinyl ether (PMVE); in the same conditions that last monomer led to higher yields. Recent works in our Laboratory in partnership with the Great Lakes/Chemtura Company²¹⁷ have shown that the decreasing order of reactivity of PFP in copolymers based on various F-alkenes is as follows:



However, the obtained yields had a reversed tendency:



Ter- or tetrapolymers containing 23-65% of VDF, 25-75% of F₂C=CFOR_F, 0.3-0.5% of 2-hydropentafluoropropene and optionally, 0-30% of TFE were prepared by Bowers and Schmiegel²¹⁸. These copolymers exhibit excellent low temperature properties and processability when cured with polyhydroxy compounds or amines. Recent developments involving various M termonomers²¹⁹ (such as CTFE, HFP, *tert*-butyl α -trifluoromethacrylate, (MAF-TBE), and PMVE) have led to original poly(VDF-ter-PFP-ter-M) terpolymers yielding

a new generation of elastomers endowed with low glass transition temperatures (ca. $-45\text{ }^{\circ}\text{C}$). Indeed, the increasing order of yields of these terpolymers is as follows:

Poly(VDF-ter-PFP-ter-HFP) > Poly(VDF-ter-PFP-ter-MAF-TBE) > Poly(VDF-ter-PFP-ter-PMVE) > Poly(VDF-ter-PFP-ter-TFP) terpolymers

Longer 2H-perfluoroalkene such as $\text{F}_2\text{C}=\text{CHC}_6\text{F}_{13}$ ²²⁰ was also synthesized from the dehydroiodination of $\text{ICF}_2\text{CH}_2\text{C}_6\text{F}_{13}$ (this latter being the monoadduct telomer obtained from the radical telomerization of VDF with $\text{C}_6\text{F}_{13}\text{I}$ ²²¹). The kinetics of copolymerization led to the reactivity ratios $r_{\text{VDF}} = 12.0$ and $r_{\text{F}_2\text{C}=\text{CHC}_6\text{F}_{13}} = 0.90$ at $74\text{ }^{\circ}\text{C}$ ²²⁰.

3.2.6. Poly(VDF-co-3,3,3-trifluoropropene) Copolymers

The Shin Etsu Company²²² claimed the suspension copolymerization of VDF and 3,3,3-trifluoropropene (TFP). In both cases, the feed TFP was very low (1-12 mol. %). The resulting copolymers have good flexibility, weather and corrosion resistance, electrical properties, and processability. A 93.2:6.8 VDF:TFP copolymer had torsional rigidity $2900\text{ kg}\cdot\text{cm}^2$, vs. 7000 for VDF homopolymer. Recent investigations²²³ report that TFP copolymerizes with VDF in all proportions. Unexpectedly, TFP is more incorporated in the copolymer than VDF and their reactivity ratios have been assessed: $r_{\text{VDF}} = 0.07$ and $r_{\text{TFP}} = 2.27$ at $75\text{ }^{\circ}\text{C}$ ^{223b} (Table 2). In addition to the above sub-section, poly(VDF-ter-TFP-ter-PFP) terpolymers were also claimed in a patent as original fluoroelastomers²¹⁹.

Recently, the Honeywell International Inc.²²⁴ has successfully produced moisture and oxygen barrier materials from poly(VDF-co-2,3,3,3-tetrafluoropropene) copolymers which have never been reported in the literature.

3.2.7. Poly(VDF-co-bromofluoroalkenes) Copolymers

Comonomers bearing bromine end atom have already been involved in co-, ter- or tetrapolymerization with VDF and have led to interesting crosslinkable copolymers terpolymers or tetrapolymers containing VDF units. Among them, eight have already led to various developments: $\text{H}_2\text{C}=\text{CHCF}_2\text{Br}$ ²²⁵, $\text{H}_2\text{C}=\text{CHC}_2\text{F}_4\text{Br}$ ²²⁶, $\text{H}_2\text{C}=\text{CHC}_6\text{F}_{12}\text{Br}$ ²²⁷, $\text{F}_2\text{C}=\text{CHBr}$ ²²⁸, $\text{F}_2\text{C}=\text{CFBr}$ ²²⁹, $\text{F}_2\text{C}=\text{CFC}_2\text{H}_4\text{Br}$ ²³⁰, $\text{F}_2\text{C}=\text{CFOC}_2\text{F}_4\text{Br}$ ²³¹, and $\text{F}_2\text{C}=\text{CFCF}_2\text{Br}$ ²²⁵. Most of these monomers behave as cure site monomers (CSM) for fluoropolymers capable of giving a vulcanized product with a good compression set or melt-processible thermoplastic fluoropolymers, where only a small amount of halogen-containing CSM was included in the copolymerization through peroxide vulcanization. That procedure induces good mechanical properties for different applications. Several patents described such kind of fluoroelastomers,

process for peroxide vulcanization. Peroxide vulcanization of the compounded rubber (containing triallyl isocyanurate) gave vulcanizates endowed with improved mechanical properties (especially modulus, tensile strength, elongation, and compression set) as in Scheme 14.

INSERT SCHEME 14

Another potential thermoplastic application from graft copolymers containing VDF was to achieve the synthesis of original trifluorovinyl macromonomer containing an oligo(VDF) chain bearing a bromine side group for crosslinking²³², as in Scheme 15.

INSERT SCHEME 15

3.2.8. Poly(VDF-co-Hexafluoroacetone) and poly(VDF-co-3-ketofluoroalkylglutaroyl halides) Copolymers

Copolymers of VDF with hexafluoroacetone^{192a} were first produced by the DuPont Company in the late 60ies. They are crystalline and attractive for their electrical properties, as claimed by Central Glass^{192b}.

Almost 30 years ago, the radical copolymerization of VDF with 3-ketofluoroalkylglutaroyl halides (or terpolymers based on VDF, HFP or VDF, TFE and these carbonyl containing comonomers), initiated by perfluoropropionylperoxide, led to original co- (or ter-) polymers bearing gem-diCF₂COX (with X = F,Cl or even OCH₃ after esterification with methanol)¹⁹³ as shown in Scheme 16.

INSERT SCHEME 16

Advantageously, zinc acetate was added and the mixture was press-heated at 190 °C to give tough, flexible films as memory shape material endowed with no further shrinkage.

3.2.9. Poly(VDF-co-perfluoroalkyl Vinyl Ether (PAVE)) copolymers

3.2.9.1 Introduction

Although perfluoroalkyl vinyl ether are expensive monomers, their use in radical copolymerization with either TFE or VDF enabled to decrease the crystallinity rate of PTFE and PVDF, and even in that latter polymer to obtain elastomers (see section “HFP”). The challenge in that area is still to reach T_{gs} lower than – 40 °C for low resistance temperature-applications. Hence, the synthesis of softer copolymers, e.g. including perfluoroalkoxy alkyl

vinyl ethers (PAAVEs) have been used and exceptional low Tgs were reached. Further, an abundant literature reports that, under radical conditions, functional perfluoroalkyl vinyl ethers (PAVEs) or perfluoroalkoxy alkyl vinyl ethers (PAAVEs) can copolymerize with TFE, leading to proton exchange membrane for fuel cell, PEMFC (Figure 2)²³³. In contrast to these thermoplastic copolymers, those obtained from the copolymerizations of PAVE (or even better in the case of PAAVE) with VDF exhibit interesting elastomeric properties when the mol. Percentage VDF was lower than 85 %, although little development has been achieved. Indeed, the ether group(s) brought by the PAVE (or PAAVE) comonomer enables the macromolecule to exhibit a low glass transition temperature and in certain cases, elastomers resistant to low temperature endowed with good thermal stability have been obtained, summarized below.

3.2.9.2 Copolymerization of VDF with Nonfunctional PAVEs

The first radical copolymerization of VDF with perfluorovinyl methyl ether (PMVE) was pioneered by Albin and Gallagher²³⁴ in the 1960ies from an emulsion process, yielding copolymers containing with a temperature of flexibility ranging from -28 to -24 °C. This reaction evidenced the poor reactivity of PMVE which does not homopolymerize ($r_{\text{PMVE}} = 0$; $r_{\text{VDF}} = 3.4$ at 74 °C²³⁵ or $r_{\text{PMVE}} = 0.11$; $r_{\text{VDF}} = 1.06$ ^{200b} ; Table 2). However, adding traces of TFE led to commercially available Viton[®] GLT (from DuPont Performance Elastomers) endowed with outstanding properties^{4,6-8}. This terpolymer exhibits the following repeating unit structure (Scheme 17):

INSERT SCHEME 17

In 1966, the NASA²³⁶ published a report describing similar interest, dealing with exotic copolymerizations of VDF with $\text{F}_2\text{C}=\text{CFOC}_n\text{F}_{2n+1}$ ($n = 1, 2, 3$) in drastic conditions (initiated by AIBN at high pressure ($P > 1000$ atm)). The authors obtained fluoroelastomers, the Tgs of which ranged from -25 to -20 °C.

PMVE or perfluoro-*n*-propyl vinyl ether (PPVE) was shown to readily copolymerize with VDF in solution, initiated by peroxides yielding poly(VDF-co-PMVE) and poly(VDF-co-PPVE) copolymers with interesting elastomeric behaviors since Tgs were as low as -44 °C^{235,237}.

Perfluoroalkoxy alkyl vinyl ethers (PAAVEs) were also copolymerized with VDF in emulsion leading to poly(VDF-co-PAAVE) fluoroelastomers²³⁸ endowed with T_g s ranging between -36 and -29 °C (Scheme 18).

INSERT SCHEME 18

These copolymers showed excellent low temperature resistance, alcohol resistance and high thermostability (up to 380 °C). In certain cases, these authors carried out ternary polymerization of these above comonomers with either perfluoro-n-propyl vinyl ether or 2-bromo-perfluoroethylvinyl ether which enabled crosslinking in a further step.

The Daikin Company²³⁹ patented a comonomer with three ether bridges such as $F_2C=CF[OCF_2CF(CF_3)]_2OC_3F_7$ and its solution copolymerization (in 1,2,2-trifluoroethane), initiated by a chlorofluorinated perester. The T_g s of the resulting copolymers could reach -44 °C. In addition, the challenge to lower the T_g s (as low as -119 °C) could be reached by the 3M company²⁴⁰ that claimed synthesizing original copolymers based on VDF and PAAVE that contained perfluoropolyethers. More recently, iodine transfer copolymerization of VDF and PMVE was successfully achieved in the presence of 1,4-diiodoperfluorobutane as the chain transfer agent²⁴¹. That radical copolymerization is regarded as controlled (or *pseudoliving*) (section 3.3). The resulting poly(VDF-co-PMVE) copolymers of $M_n < 3,000$ g.mol⁻¹ had T_g values of ca. -60 °C for satisfactory thermal stability. These fluorinated diiodides led to original telechelic dihydroxy, diacrylates, bis(triethoxysilanes) poly(VDF-co-PMVE) copolymers, as precursors of novel crosslinked elastomers²⁴².

A deeper investigation in our group has recently consisted in assessing the reactivity ratio of both comonomers (r_{VDF} and r_{PMVE}) in the radical copolymerization of VDF and PMVE in emulsion. This can be deduced by plotting $\ln[VDF]/[VDF]_0$ versus $\ln[PMVE]/[PMVE]_0$. r_{VDF} can be assessed from the value of the slope of the straight-line of $\ln[VDF]/[VDF]_0$ versus $\ln[PMVE]/[PMVE]_0$ (Figure 23), according to Jaacks' law²⁴³. From the consumption of PMVE and VDF in the course of the reaction, it was possible to assess their reactivity ratios: $r_{VDF} = 2.53$ and $r_{PMVE} = 0$ at 80 °C in aqueous solution²⁴⁴, which are rather close ($r_{VDF} = 3.40$ and $r_{PMVE} = 0$ at 74 °C²³⁵) to those achieved in in organic medium. This shows again that PMVE does not homopropagate, confirming that whatever the feed, the content of VDF in the copolymers is always higher than that in the feed.

INSERT FIGURE 23

3.2.9.3 Radical Copolymerization of VDF with Functional PAVEs or PAAVEs

In contrast to many studies which report the radical copolymerization of TFE with functional perfluoroalkoxyalkyl vinyl ethers (mainly those containing a sulfonyl fluoride useful for fuel cell membrane applications²³³), a few investigations deal with that of VDF²⁴⁵⁻²⁴⁷.

Indeed, the former part concerns the synthesis of novel materials for fuel cell membranes such as Nafion[®], Flemion[®], Hyflon[®] Ion, and Fumion[®] and more recently 3M[®] Membrane²⁴⁸ marketed by DuPont, Ashai Glass Co., Solvay Solexis, Fumatec, and 3M companies, respectively (Scheme 19):

INSERT SCHEME 19

Functional perfluoroalkoxyalkyl vinyl ethers and mainly those containing a sulfonyl fluoride or their derivatives were also successfully copolymerized with VDF in various processes.

First, Ezzel and Carl²⁴⁹ encompassed copolymers of VDF and perfluorovinyl ethoxy sulfonyl fluoride. Then, Connolly and Gresham²⁵⁰ disclosed the copolymerization of VDF with perfluoro(4-methyl-3,6-dioxaoct-7-ene) sulfonyl fluoride (PFSVE) and the terpolymerization involving HFP, in an emulsion process, but using a small amount of functional comonomer so that only 0.2 to 5.0 mol. % was present in the copolymer. Investigations in partnership with Hydro-Quebec led to a wider range of fluorinated copolymers^{246,247} or terpolymers (involving HFP)²⁵¹.

In addition, Feiring *et al.*²⁴⁵ have also investigated the emulsion copolymerization of VDF with various functional comonomers such as $F_2C=CFOCF_2CF(CF_3)OC_2F_4R$ where R represents $NHSO_2CF_3$ (also reported by DesMarteau²⁵²), $SO_2CLi(SO_2CF_3)_2$, $SO_2NLiSO_2CF_3$ and SO_2F (PFSVE)²⁴⁵. In the case of the last system, the copolymers have a Tg of -20 °C and no weight-loss was noted up to 375 °C. These copolymers with pendant groups containing fluorosulfonyl methide or fluorosulfonyl imide derivatives are original fluorinated ionomers that have been claimed to be used in applications such as batteries, fuel cells, electrolysis cells, ion exchange membranes, sensors, electrochromic windows, in electrochemical capacitors and for modified electrodes.

Recently, the radical terpolymerization of VDF with PFSVE and 4-bromo-3,3,4,4-tetrafluorobut-1-ene (BDFO) led to interesting terpolymers which could be crosslinked via the bromine atom in the presence of ROOR peroxides and triallyl isocyanurate (TAIC), as in Scheme 20²⁵³.

INSERT SCHEME 20

3.2.10. Poly(VDF-co-Functional perfluorovinyl monomer) copolymers

In contrast to the above perfluorovinyl ethers that propagate with difficulty in radical homopolymerization (only hydroxy terminated perfluorovinyl ethers homopolymerize under ionic conditions²⁵⁴), several attempts of copolymerizations of VDF with $F_2C=CF-R-G$ (where G and R represent a functional group and a hydrogenated spacer, respectively) have shown that these monomers easily homopolymerize. Such original monomers enable the resulting copolymers to be efficiently crosslinkable with routes different from those usually involved (by means of diamines, bisphenols, peroxides or by radiations¹⁰).

Pioneering work was carried out by the Daikin Company²⁵⁵ from various functional monomers such as: $F_2C=CF(CF_2)_n(CH_2)_mOH$ where $n=0, 1, 2$ and $m=1-3$.

The synthesis of the monomers was described in the same patent, while the optimization of $F_2C=CF(CH_2)_nOR$ (where $n=1$ or 3 and $R=H$ or Ac) was later on achieved²⁵⁶. Other functional trifluorovinyl monomers have also been prepared: either bearing an ω -insaturation²⁵⁷⁻²⁵⁹, or a carboxylic²⁶⁰⁻²⁶¹, a nitrile²⁶², an amide²⁵⁸, a sultone²⁵⁷, an epoxide²⁶³, a hydroxyl^{255, 256, 260, 264}, or a thioacetoxyl group^{265,266}. More exotic routes to trifluorovinyl end-group in metallic complexes have also been reviewed²⁶⁷. Radical copolymerizations of VDF with $F_2C=CF(CH_2)_3OR$ ^{255,264} (according to the nature and the amount of the functional monomer, the T_g values were ranging from -23 to -8 °C²⁵⁵) or with $F_2C=CF(CH_2)_3SCOR$ ^{265,266} were achieved, leading to original copolymers²⁶⁶ which even could be crosslinked in the presence of telechelic diene *via* the “thiol-ene” process, as in Scheme 21.

INSERT SCHEME 21

Another interesting strategy to involve “cure site monomer” in the radical copolymerization in solution was achieved from $F_2C=CF(CH_2)_3Si(OR)_3$ (with $R=Et$ or Me) comonomers²⁶⁸. The resulting copolymers were crosslinked in the presence of acidic water.

As mentioned in the above sub-section, further fluorinated monomers bearing a bromine end-group potentially enable the crosslinking of the resulting copolymers. This is the case of $CF_2=CF-CH_2-CH_2-Br$, C_4Br ^{230c}, the bromine atom of which can also be chemically changed into other functional groups (acetate, thioacetate, phosphonate²⁶⁹, trialkoxysilane²⁶⁸ (Scheme 22), which could be either allow crosslinking or could be hydrolyzed into phosphonic acid). A recent study on the radical copolymerization of VDF with C_4Br , followed by a chemical

modification (via Arbuzov) has led to new poly(VDF-co-C₄P) copolymers (where C₄P stands for CF₂=CF-CH₂-CH₂-P(O)(OH)₂ unit) for which the phosphonic acid enables protonic exchange for PEMFC²⁶⁹.

INSERT SCHEME 22

In the same way, poly(VDF-co-CF₂=CF-CH₂-CH₂-Br) copolymers have been synthesized and could be modified into original copolymers bearing quaternary ammonium function (Scheme 23)²⁷⁰.

INSERT SCHEME 23

3.2.11. Radical copolymerization of VDF with Fluoroacrylates

According to Q and e values (Q_{acrylate} = 0.5-0.9 and e = 0.22-1.1)²⁷¹, the radical copolymerization of VDF with an acrylate does not occur²⁷⁰ since it leads to a homopoly(acrylate). A similar behavior was also noted when VDF reacted with an α -fluoro acrylate. However, a Japanese patent surprisingly claims that such an emulsion copolymerization was possible²⁷².

Amazingly, though the radical copolymerization of VDF with an α,β -difluoroacrylate has not been yet investigated²⁷⁰, it was worth investigating the synthesis of a di-fluoroacrylate which does not possess any fluorine atom in α -position to the ester function. This original monomer (3) or (3') was synthesized by the radical addition of bromotrichloromethane onto VDF leading to 1,1,1-trichloro-3-bromo-3,3-difluoropropane monoadduct (1), the trichloromethyl of which was oxidized into (2) or (2'), followed by a dehydrobromination, as in Scheme 24²⁷³:

INSERT SCHEME 24

Interestingly, the radical copolymerization of VDF with a β,β -difluoroacrylate²⁷⁰ was successfully achieved. For example, starting from a molar feed content (VDF / β,β -difluoroacrylate) of 90/10, the resulting copolymer contained 86 mol.% of VDF. Figure 24 represents the ¹⁹F NMR spectrum of the produced copolymer, showing the characteristic signals of VDF centered at -93, -115 and -117 ppm assigned to -CH₂CF₂-CH₂CF₂, -CH₂CF₂-CF₂CH₂, respectively. More interesting are both AB systems centered at about -110 and -116

ppm, assigned to the difluoromethylene signals in the $-\text{CH}_2\text{CF}_2-\text{CF}_2\text{CH}(\text{CO}_2\text{R})-$ diad arising from the presence of the asymmetric carbon atom and the bulky ester linked to it.

Surprisingly, the macroradical terminated by $\text{CH}_2\text{CF}_2^\circ$ group was also able to react onto the more hindered site of β,β -difluoroacrylate leading to a reversed chaining (Chaining R) (Scheme 25).

INSERT SCHEME 25

The evidence of that mechanism could be highlighted from the presences of complex signal centered at -96.5 ppm assigned to both CF_2 groups in the $-\text{CH}_2\text{CF}_2-\text{CH}(\text{CO}_2\text{R})\text{CF}_2-\text{CH}_2\text{CF}_2-$ triad.

Only two monomers bearing three fluorine atoms linked to the ethylenic carbon atoms of a fluorinated acrylate, α,β,β -trifluoroacrylate and α -trifluoromethacrylate, are known not to homopolymerize²⁷⁴ under radical conditions (when initiated by AIBN or dibenzoyl peroxide). However, both methyl trifluoroacrylate^{275,276} and α -trifluoromethacrylic acid (MAF)¹⁹¹ (Scheme 26) or *tert*-butyl α -trifluoromethacrylate (MAFTBE) led to alternating copolymers successfully.

INSERT FIGURE 24

INSERT SCHEME 26

As in Figure 23, the chemical shift of the central difluoromethyl group adjacent to both methylene groups in the VDF-MAF¹⁹¹ or VDF-MAFTBE- diads show a characteristic signal centered at -95 ppm.

3.2.12. Radical Copolymerization of VDF with Other Monomers

In addition, the radical copolymerization of VDF with α -trifluoromethyl vinyl acetate (TFMVAc) has scarcely been investigated. It was pioneered by the Polaroid Company²⁷⁷ (and then, its kinetic was studied by our team²⁷⁰). Unexpectedly, TFMVAc is more reactive than VDF²⁷⁰ though its radical homopolymerization initiated by dibenzoyl peroxide led to a very low molecular weight in poor yield²⁷⁸ (the limiting parameter arises from the slow propagation rate^{278,279}). This higher reactivity of TFMVAc was evidenced by two statements: i) first, the ¹⁹F NMR spectra of the various poly(VDF-co-TFMVAc) copolymers revealed the presence of three following chemical shifts assigned to CF_3 of TFMVAc in the triads:

-66 to -67 ppm: $-\text{[CH}_2\text{C(CF}_3\text{)OAc]-[CH}_2\text{C(CF}_3\text{)OAc]-[CH}_2\text{C(CF}_3\text{)OAc]-}$

ca. -70 ppm: $-\text{[CH}_2\text{C(CF}_3\text{)OAc]-[CH}_2\text{C(CF}_3\text{)OAc]-CH}_2\text{CF}_2\text{-}$

-72.9 ppm: $-\text{CH}_2\text{CF}_2\text{-[CH}_2\text{C(CF}_3\text{)OAc]-CH}_2\text{CF}_2\text{-}$;

ii) second, assessing the reactivity ratios led to: $r_{\text{VDF}} = 0.16 \pm 0.10$ and $r_{\text{TMFVAc}} = 7.6 \pm 1.2$ at $55\text{ }^\circ\text{C}^{270}$, showing a poor reactivity of VDF.

An atypic radical copolymerization of vinyl acetate (VAc) with VDF has been investigated either in supercritical CO_2^{280} , in suspension²⁸¹, or in solution^{270,282}, showing that VAc is more incorporated than VDF (Table 2). VAc has three limitations: i) it is too reactive and forms PVAc chains; ii) it does not possess any fluorinated atom on the double bond and thus the resulting copolymers cannot have the same thermal stability as that of PVDF; iii) it is known that a proton located in α position of the double bond induces the transfer reaction to polymer²⁸³.

In contrast, the radical copolymerization of VDF with hydrogenated vinyl ethers (VEs) has never been mentioned in the literature, contrarily to the production of alternated copolymers based on CTFE and VE (Lumiflon®) or TFE and VE (Zeffle ®) marketed by Asahi Glass Co and Daikin, respectively⁴.

Furthermore, VDF was also involved in the radical copolymerization with monomers bearing cyano groups²⁸⁴ showing that neither acrylonitrile nor methacrylonitrile nor vinylidene cyanide copolymerized successfully with VDF leading to homopolymers based in these cyanomonomers exclusively.

Quite a few allylic monomers have been incorporated in the copolymerization of VDF. The Kureha²⁸⁵ Company claimed that the allyl glycidyl ether led to copolymers containing few amount of that oxirane and the resulting copolymer (the melting point of which is 160-175 $^\circ\text{C}$) was used for lithium battery applications, after a crosslinking reaction *via* the epoxide side groups.

The same strategy was also attempted by Perillon *et al.*²⁸⁶⁻²⁸⁸ who were able to incorporate more allyl glycidyl ether (ca. 4.3 mol. %) ²⁸⁶ from its radical copolymerizations with VDF or with VDF and TFE. In addition, these authors used other hydrogenated functional allylic comonomers such as monoallyl-1,2-cyclohexanedicarboxylate²⁸⁸, allyl diol²⁸⁹, ω -functionalized $\text{C}_n\text{F}_{2n+1}$ end-group²⁹⁰). The three former produced terpolymers ($M_n=7,800\text{-}9,000\text{ g.mol}^{-1}$) were crosslinked either with N,N,N',N'-tetrakis(2-hydroxyethyl)adipamide (for a CO_2H content of 0.67 meq.g^{-1} ²⁸⁸), melamine²⁹¹, *via* Lewis acid (such as $\text{Ph}_3\text{S}^+\text{SbF}_6^-$

²⁸⁶), isophorone diisocyanate²⁹⁰, or *via* HDI-based polyisocyanate ^{289a}). These crosslinking steps were required to induce a high solvent resistance (especially to MEK) and the main application of these materials was for formulations of original coatings (CX 2000[®] from Elf Atochem) to compete with Lumiflon[®] paints from the Asahi Glass Chemical Company. To complete that area, Tournut^{292,293} published two very interesting reviews on the radical copolymerizations of VDF with functional hydrogenated comonomers for paints applications. Another exotic and surprising copolymerization of VDF was that involving vinyl monomer bearing a fluorinated substituent $H_2C=CHC_nF_{2n+1}$ ($n>4$) as claimed in Shin Etsu's patents ²²². More recently, the Solvay Company²⁹⁴ has developed new maleimized PVDF copolymers containing a few amounts (< 1 mol. %) of maleic anhydride comonomer, under the Priex[®] trademark. Recently, that company has transferred the Priex[®] technology to Addcomp Company. Similar copolymers based on VDF (or containing various other fluoroalkenes (FA)) have also been achieved by Arkema²⁹⁵ under the Kynar[®] ADX tradename, by extrusion of PVDF or poly(VDF-co-FA) copolymers in the presence of a few amount of maleic anhydride. These resins preserve the same excellent melt and solvent processability, and features equivalent thermal, UV and chemical resistance, high mechanical performance and high permeation barrier properties as Kynar[®] and Kynar[®] Flex resin do. Their applications are in diverse fields as transport fuel lines, battery binders, and rubber and metal coatings.

Interestingly, the radical copolymerization of VDF with hexafluoroisobutylene (HFIB) led to an alternating poly(VDF-alt-HFIB) copolymer, commercially available by the Allied Company (nowadays by Honeywell International Inc.)^{296,297}. This only industrial alternating copolymer based on VDF has exceptional properties (high crystallinity, melting ($T_m = 327$ °C) and glass transition ($T_g = 132$ °C) temperatures, arising from both CF_3 side groups ensuring a good protection of the backbone. A summary on the history of that product has been reviewed²⁹⁸.

INSERT FIGURE 25

3.2.13. Kinetics of Radical Copolymerization

The radical copolymerization enables to classify the comonomers according to their reactivities, and it is worth investigating the kinetics of copolymerization of VDF with various comonomers (Table 2) to compare their reactivities about VDF.

Usually, four main equations of propagation of macroradicals onto either VDF or onto the comonomer are under competition (Scheme 27):

INSERT SCHEME 27

The intrinsic reactivity of both comonomers can be obtained from the assessment of their reactivity ratios which worth the ratio of the propagation rates (Scheme 28).

INSERT SCHEME 28

INSERT TABLE 2

Concerning a theoretical point of view, the kinetics of radical copolymerizations of various (VDF, M monomer) couples have also been studied, showing that the reactivity ratio of VDF could be lower than those of certain functional comonomers^{201,224,230,264,270,299-304} (Table 2). The reactivity ratios r measured in the copolymerizations of VDF with monomers bearing various substituents are gathered in Table 2. Value of r less than 1 indicates a tendency of the radicals to crosspropagate rather than to homopolymerize. Figure 25 represents the monomer-polymer composition curve for the radical copolymerization of VDF with various comonomers and shows different profiles ranging from random to alternating copolymerizations.

Indeed, a reactivity series of fluorinated monomers about VDF can be supplied using the traditional method for the determination of relative reactivity of a macroradical to several monomers. It is common to compare the values $1/r_A = k_{AB}/k_{AA}$ as the ratio of rate constants of crossed propagation to that of propagation (k_{AA}). Thus, the higher the $1/r$ value, the more able the radical is to react with the second monomer. Table 2 allows one to suggest the following series of relative reactivities of monomers to $\sim\sim\sim\sim\sim$ VDF \bullet radicals^{235,264,265,276,299-311}:

$F_2C=CHC_6F_{13} < F_2C=CHCF_3 < F_2C=C(CF_3)COF < HFP < PMVE < BDFE < PPVE < VDF < TrFE < F_2C=CFCH_2CH_2Br < F_2C=CFCH_2OH < F_2C=C(CF_3)OCOC_6H_5 < F_2C=CFO(HFP)OC_2F_4SO_2F < CTFE$ (recent value) $< TrFE < BrTFE < H_2C=CF CF_2OR_F < H_2C=C(CF_3)CO_2H < F_2C=CF CO_2CH_3 < TFE < F_2C=CFC_3H_6SCOCH_3 < F_2C=CFC_3H_6OAc < H_2C=CHF \approx CTFE$ (old value) $< TFP < ethylene$, although numerous kinetics still deserve to be investigated as that involving VDF.

3.2.14. Radical copolymerization of VDF with aromatic monomers

To the best of our knowledge, the radical copolymerization of VDF with aromatic monomers has scarcely been reported. This is mainly due to the lack of copolymerizability since the Q value of aromatics ($Q_{\text{styrene}}=1$) are higher than that of VDF ($Q_{\text{VDF}}=0.036^{293}$, 0.008^{201} , or 0.015^{271}). However, few aromatic terpolymers based on VDF have been synthesized. Trifluorovinyloxy aromatic brominated¹⁹⁴ or sulfonyl chloride¹⁹⁵ were chosen as monomeric precursors of copolymers electrolyte for fuel cell membranes but the poor reactivity of these aromatic monomers (sometimes leading to a certain inhibition) and the β -scission that occurred from the trifluorovinyloxy end-radical in the course of the polymerization thus led to low ionic exchange capacities and poor conductivities. The straightforward synthesis of the preparation of terpolymers bearing sulfonic acid for fuel cell membranes is in Scheme 29.

INSERT SCHEME 29

3.2.15. Conclusion

Random copolymers containing VDF units and aliphatic comonomers are numerous while those based on aromatic comonomers are scarce. The nature and the number of substituents born by the ethylenic carbon atoms induce great polar and steric effects on their reactivity towards VDF. The use of cure site monomer is original and obviously various companies have taken advantage to produce new generations of fluorinated copolymers with improved performances. Although increasing number of studies on the upstream preparation of functional fluoromonomers for fuel cell membranes has been noted, it is understood that few of them report membranes for alkaline fuel cells because of dehydrofluorination reaction of VDF-containing copolymers in basic media. Indeed, many efforts have been made in the last decade to find out suitable functional comonomers.

3.3 Random Copolymers Synthesized by Controlled Radical Polymerization (CRP)^{47-51,312}

3.3.1 Introduction

The controlled radical (co)polymerization has drawn much interest since mid-90ies⁴⁷⁻⁵¹ and this development has also involved fluoroalkenes⁴ or pentafluorostyrene³¹³. In contrast to many surveys dealing with the CRP from nitroxide mediated polymerization (NMP), atom

transfer radical polymerization (ATRP), reversible addition fragmentation transfer (RAFT) which have not been reported for fluoroalkenes (except for the ATR copolymerization of 1H, 1H, 2H-perfluorooct-1-ene with methyl acrylate³¹⁴) the use of borinate^{51,78,125,128,138} or the macromolecular design by interchange of xanthate^{5,49,50} (MADIX), and the iodine transfer polymerization^{4,48,312} have been the most suitable methods. This last pioneered method of CRP was developed by Tatemoto in the late 70ies^{4,48}.

3.3.2. Controlled Poly(VDF-co- α -trifluoromethacrylic acid) Copolymers

Few examples in these three latter systems are given hereafter, starting from the iodine transfer copolymerization of VDF with α -trifluoromethacrylic acid (MAF) that was successfully achieved in emulsion³¹⁵, initiated by a persulfate, in the presence of C₆F₁₃I or IC_nF_{2n}I (n= 4 or 6) as the chain transfer agents (CTAs) but without any surfactant³¹⁵, the carboxylic acid enabling the self-emulsion of the process (Scheme 30).

INSERT SCHEME 30

The molecular weights of the resulting copolymers could be targeted from the ([VDF]₀ + [MAF]₀) / [(I)R_FI]₀ initial molar ratios. They reached values up to 220,000 g.mol⁻¹ from IC₆F₁₂I as the CTA. As an example, the ¹⁹F NMR spectrum (Figure 26) enables to assess the mol. % of both comonomers and the molecular weights from the integrals of the characteristic signals centered at -92, -95, -115, -118 ppm assigned to VDF and at -69 ppm for MAF, and thanks to the eight fluorine atoms of the CTA centered in the -122 to -125 ppm range.

INSERT FIGURE 26

3.3.3. Controlled Poly(VDF-co-Perfluoromethylvinylether) Copolymers

A recent investigation deals with the iodine transfer copolymerization of VDF and PMVE achieved in emulsion, in the presence of C₆F₁₃I or 1,4-diiodoperfluorobutane as the chain transfer agent²⁴¹ but in the absence of surfactant (Scheme 31).

That radical copolymerization is regarded as controlled or *pseudoliving*. The microstructure of these α,ω -diiodopoly(VDF-co-PMVE) copolymers well evidenced by ¹⁹F NMR spectroscopy (Figure 26), revealed VDF-I end-groups, and the absence of VDF reversed chaining. For average molar masses lower than 2,500 g/mol, 100 % CH₂CF₂I extremities were observed while some -CF₂CH₂-I end groups were noted for M_n > 2600 g.mol⁻¹. The nature of

the CTA ($C_6F_{13}I$ or $IC_nF_{2n}I$) did not affect the yield of the copolymerization *versus* the PMVE feed mol. % (Figure 27). As expected, the T_g values were low (ca. -60 °C) for satisfactory thermal stability. These fluorinated diiodides derivatives led to original telechelic dihydroxy, diacrylates, bis(trialkoxysilanes) poly(VDF-co-PMVE) copolymers, as precursors of novel crosslinked elastomers²⁴².

INSERT SCHEME 31

INSERT FIGURE 27

In addition, the reactivity ratios of both comonomers have been assessed ($r_{VDF} = 2.53$ and $r_{PMVE} = 0$ at 80 °C²⁴⁴ in emulsion copolymerization).

INSERT FIGURE 28

3.3.4 Controlled Poly(VDF-ter-HFP-ter- $F_2C=CFSF_5$) Terpolymers

A similar strategy was also achieved for the terpolymerization of VDF with HFP and 1,1,2-trifluoro-2-pentafluorosulfanylethylene (Scheme 32 where Y represents a fluorine atom) with $C_6F_{13}I$ as the CTA, and initiated by *tert*-butyl peroxyvalate (TBPPI)¹⁹⁷. Original terpolymers were produced, and the concentration of the CTA influences their molar masses (narrow polydispersity indices were obtained, Figure 29A) and the thermal properties of the resulting terpolymers¹⁹⁷. The controlled of that reaction was evidenced by the linear dependence of the average molar masses *versus* the monomer conversion (Figure 29B).

INSERT FIGURE 29

INSERT SCHEME 32

3.3.5. Poly(VDF-co-comonomer) Copolymers Controlled by Borinates

A more recent technique, developed at the Penn State University^{51,78,128,138} and involving a borinate as the counter radical, already used for hydrogenated monomers (e.g., acrylics), was successfully applied for the controlled radical copolymerization of VDF with vinyl silanes or fluoroalkenes such as CTFE, HFP or TrFE (Scheme 33):

INSERT SCHEME 33

BR_3 borane reacts with oxygen to generate RO-OBR_2 in which the oxygen-oxygen bond undergoes a homolytic cleavage to produce RO° and $^\circ\text{OBR}_2$ borinate. In fact, RO° is an efficient oxygen centered radical able to initiate the homopolymerization of VDF (or the copolymerization of VDF with various other co-monomers). In contrast, $^\circ\text{OBR}_2$ radical is too stabilized and is not able to initiate any polymerization. This stability arises from the backdonating effect of the free electron born by the oxygen atom to the empty orbital of boron atom. However, $^\circ\text{OBR}_2$, as a counter radical, traps (or quenches) any radical by recombination and controls the polymerization *via* a fast equilibrium between the active species and the dormant ones.

Original poly(VDF-co-CTFE) copolymers and also poly(VDF-ter-CTFE-ter- $\text{F}_2\text{C}=\text{CF-R-Si}(\text{OR})_2\text{CH}_3$) terpolymers (Scheme 8) were first synthesized in a controlled manner in solution or in bulk at ambient temperature though the yield were lower than 65%^{125,128}.

3.3.6. Poly(VDF-co-comonomer) Copolymers Controlled *via* Xanthates

Besides ITP and radical copolymerizations controlled by borinates, the controlled radical copolymerizations of VDF with other F-comonomers such as HFP, TFP, and PFSVE were successfully carried out in the presence of xanthate.

After being created, the macromolecular chains (P_n) subsequently undergo a transfer to the xanthate⁴⁹. Finally, the main reversible addition fragmentation transfer (RAFT) occurs, thus inducing a fast equilibrium between the active and the dormant species (Scheme 34). Then, P_m° macroradical reacts onto the carbon atom of the $\text{C}=\text{S}$ group which rearranges into $\text{P}_m\text{-S-C(S)OZ}'$ and then generates P_n° radical able to further propagates.

INSERT SCHEME 34

A first interesting example was reported by Severac³¹⁶ who realized the controlled radical copolymerization of VDF with HFP in the presence of $\text{CH}_3\text{OCOCH}(\text{CH}_3)\text{SC(S)OEt}$ xanthate (Scheme 35). The intermediate poly(VDF-co-HFP) copolymer bearing a xanthate end-group is able to reinitiate further poly(VDF-co-HFP) or poly(VAc) chains *via* the cleavage of the C-S bond (where VAc stands for vinyl acetate).

INSERT SCHEME 35

Molar masses and polydispersity indices for the intermediate copolymer was 6,500 g.mol⁻¹ (eq. PMMA standards) and 1.47, respectively, while those of poly(VDF-co-HFP)-b-poly(VDF-co-HFP) and poly(VDF-co-HFP)-b-PVAc block copolymers were 10,600 g.mol⁻¹ and 1.48, and 9,400 g.mol⁻¹ and 1.59, respectively. These results indicate an interesting control of that copolymerization with an increase of the molar masses and reasonable narrow polydispersities.

An original fluorinated xanthate was also synthesized³¹⁷ in two steps (Scheme 35).

INSERT SCHEME 36

First, a radical copolymerization of VDF and HFP controlled by such a fluorinated xanthate was carried out and led to molar masses of 13,000 g.mol⁻¹. Then, the resulting poly(VDF-co-HFP)-xanthate was involved into two reactions: i) first, the radical polymerization of VDF (reaction REMX2-1) to achieve the synthesis of poly(VDF-co-HFP)-b-PVDF block copolymers, the SEC chromatogram of which showed a shift toward lower elution time (Figure 30; i.e., higher MW of ca. 20,000 g.mol⁻¹ assessed by ¹⁹F NMR spectroscopy);

ii) the second reaction (REMX2-2) reported the radical copolymerization of HFP and VDF in feed ratio VDF/HFP= 70 / 30 mol. % / mol. % to lead to poly(VDF-co-HFP)-b-poly(VDF-co-HFP) block copolymers.

A similar strategy was also successfully applied for the synthesis of poly(VDF-co-PFSVE)-b-poly(VDF-co-HFP) block copolymers from poly(VDF-ter-HFP-ter-PFSVE) sequence (Scheme 37)³¹⁷. The searched application for these copolymers was to supply original fuel cell membranes, though the hydrolysis of SO₂F into SO₃H was not carried out and the conductivities have not yet been assessed.

INSERT SCHEME 37

INSERT FIGURE 30

More recently, original poly(VDF-co-TFP)-b-poly(vinyl acetate) diblock copolymers have been synthesized³¹⁸ by the control of fluorinated xanthates *via* the MADIX process (Scheme 38).

INSERT SCHEME 38

The acidic hydrolysis of the poly(VAc) block led to a hydrophilic sequence making the resulting poly(VDF-co-TFP)-b-Poly(vinyl alcohol) diblock copolymers amphiphilic, and able to be used as novel surfactants. Interestingly, low critical micellar concentrations (cmcs) and surface tensions ($17 \text{ mN}\cdot\text{m}^{-1}$ for 0.5 % of copolymer) were obtained (Figure 31) almost as low as those of perfluorooctanoic acid (PFOA) or perfluorooctane sulfonic acid (PFOS)).

INSERT FIGURE 31

According to the initial molar ratios of the different reactants, of a wide range of surfactants³¹⁸ of various molar masses were prepared ranging from 600 to 5,000 $\text{g}\cdot\text{mol}^{-1}$. Although the bioaccumulation has not been investigated yet, it can be advantageously assumed that the hydrophobic poly(VDF-co-TFP) block should undergo metabolic or enzymatic decomposition arising from the methylene or methyne weak points of VDF or TFP. These block cooligomers are potential alternatives to non-bioaccumulable surfactants in contrast to PFOA or PFOS.

3.3.7 Conclusion

Only three efficient methods dealing with the controlled radical copolymerizations (CRcoP) of VDF have been achieved so far: ITP, Madix and the copolymerization in the presence of borane agents. Though these methods have not been systematically applied on each (VDF, M) couple, various products have already been developed industrially. Daiel® and Tecnoflon® copolymers, marketed by the Daikin and Solvay Solexis companies, are the first industrial products obtained by CRcoP (see section 4.1.2). In addition to well-established thermoplastic elastomers for O-rings, sealants and gaskets, further promising applications can also be deduced from that technology (fuel cell membranes, or surfactants for which it is urgent to find out alternatives regarding the cost, methanol crossover, and environment or health concerns, respectively).

4. WELL-DEFINED COPOLYMERS BASED on VINYLIDENE FLUORIDE

As mentioned above, most fluorinated copolymers are statistical. But, original well-architected containing-VDF copolymers have already been synthesized such as block, graft, alternated, or telechelic fluorocopolymers and non-exhaustive examples are supplied below.

4.1. Fluorinated Block Copolymers Based on VDF

Macromolecular engineering has become a powerful tool to design controlled architected polymers^{4,47,319}: cycles, networks, dendrimers, block, graft or alternated copolymers, star-shaped polymers, and telechelic⁴. Among them, block copolymers have received much attention as “novel polymeric materials” with multicomponents since they are made of different polymeric sequences linked together. The reason for their importance arises from their unique chemical structure that brings new physical and thermodynamical properties related to their solid-state and solution morphologies. Frequently, these copolymers exhibit phase separation producing a dispersed phase consisting of one block type in a continuous matrix of the second type. Their unusual colloidal and mechanical properties allow modification of solution viscosity, surface activity or elasticity, and impact resistance. Thus, several block^{47,319} (and even graft) copolymers have produced a wide range of materials with tailorable properties depending on the nature and the length of the sequences (or of grafts^{4,47}). They have found significant applications such as adhesives, sealants, surface modifiers for fillers and fibres, crosslinking agents for elastomers, additives for resin gelification and hardening, and compatibilizing agents or stable emulsion of homopolymer blends. Most important properties for these well-designed fluoropolymers are thermoplastic elastomers (for O-rings, shafts, diaphragms, sealants, gaskets), fuel cell membranes, surfacants, and various items (lenses, dental materials, etc...).

In this section, two ways of synthesis are considered from the traditional and controlled radical polymerizations.

4.1.1. From Traditional (or Conventional) Radical Polymerization

Several examples are given below.

By an adequate chain transfer agent involving a C-Br cleavage, Moggi *et al.*³²⁰ reacted VDF with ω -bromoperfluorinated polyethers (PFPEs) (Scheme 39) in a non-controlled process, under telomerization conditions⁴.

INSERT SCHEME 39

These PFPE-b-PVDF diblock copolymers exhibit a heterogeneous morphology with two amorphous zones assigned to both fluorinated blocks. The one attributed to the PFPE had a Tg of $-143\text{ }^{\circ}\text{C}$ in all the cases, while that of the second one depended upon the chain length of VDF blocks, hence varying from -82 to $-52\text{ }^{\circ}\text{C}$ for a number of VDF units ranging from 13 to 71.

In addition, the DuPont company develops Krytox[®] products as PFPEs and, among them, a series possesses an iodo end-group (PFPE-I). A similar investigation³¹⁸ as above was achieved leading to original PFPE-b-poly(VDF-co-HFP) diblock copolymers under telomerization conditions (Scheme 40):

INSERT SCHEME 40

According to the nature of the initiator and to the stoichiometry of the reaction, these obtained PFPE-b-poly(VDF-co-HFP) block copolymers exhibit molecular weights ranging between 1,900 and 30,000 (starting from a PFPE-I with an $\overline{M}_n = 1,300$).

Another route to synthesize block copolymers containing PVDF was proposed by Holdcroft's group³²² who prepared poly(arylene ether sulfone)-b-PVDF block copolymers from the condensation of α,ω -bis(dihydroxy)poly(arylene ether sulfone), PAES, of molecular weights 1800, 4900, and 9500 daltons with telechelic dibromooligo(VDF). That latter was achieved by well-known radical telomerization of vinylidene fluoride with 1,2-dibromo tetrafluoroethane³²³ (reaching molecular weight of ca. 1200 daltons). The structure of the block copolymer is as in Scheme 41.

INSERT SCHEME 41

Surprisingly, the authors did not mention any dehydrofluorination of the oligo(VDF) since the above condensation occurs with the presence of NaH. These Canadian authors noted that when observable, the T_g of PAES domains with the block copolymers occurred at a temperature lower than the corresponding PAES homopolymer due to the flexible nature of the surrounding PVDF regions. Block copolymers exhibited a similar thermal stability as the corresponding PAES homopolymer but a higher stability than the PVDF homopolymer.

Sulfonation of bisphenol A polysulfone-b-PVDF block copolymer (M_n of PSU was 9,500 Da) was successfully achieved³²⁴, their water uptakes were varying from 14 to 77 %, and their average number of water molecules to sulfonic acid groups, $[H_2O]/[SO_3H] = \lambda$, were 10-20, while their conductivity values were ranging from 4 to 55 $mS.cm^{-1}$, according to the sulfonic acid content.

4.1.2. From Controlled Radical Copolymerization

Though several examples of block copolymers achieved by controlled radical copolymerization have been reported in section 3.3.5, this subsection describes strategies to prepare fluorinated block copolymers by group transfer: for example those prepared by degenerative transfer involving macrotransfer agents which possess a C-X (X designates a halogen) cleavable bond. Three examples are given below where various initiators have been used.

Regarding the *C-I cleavage*, the pioneered work on ITP was realized by Tatemoto *et al.*^{48,325} in the late 70ies and these Japanese researchers synthesized poly(VDF-co-HFP)-b-PVDF block copolymers by controlled (or *pseudoliving*) iodine transfer polymerization^{48,312} using an α,ω -diiodoperfluoroalkanes ($\text{IR}_\text{F}\text{I}$ such as $\text{IC}_4\text{F}_8\text{I}$ or $\text{IC}_6\text{F}_{12}\text{I}$) which generated a first elastomeric block 1. This latter was then able to initiate the polymerization of VDF or other comonomers as in Scheme 42.

INSERT SCHEME 42

These special fluoropolymers, called thermoplastic elastomers (TPEs), launched by the Daikin Company in 1984, under the Daiel[®] trademark, are composed of soft segments (containing the poly(VDF-co-HFP) elastomeric blocks) and hard ones composed of various sequences (PVDF, PTFE, or poly(ethylene-alt-tetrafluoroethylene))³²⁶. Similar TPEs, but based on poly(VDF-co-CTFE) central copolymeric block¹⁴¹, have also been mentioned in section 3.2.1. In the first step, iodine terminated poly(TFE-ter-VDF-ter-HFP) terpolymers were synthesized by emulsion polymerization leading to α,ω -diiodopolymeric soft segments. In the second step, another emulsion polymerization (of VDF or TFE) to produce the hard segment took place in the presence of the iodine-terminated soft terpolymer to yield a Hard-Soft-Hard triblock copolymer. Daikin commercializes several grades, for example composed of one type that contains a poly(E-ter-TFE-ter-HFP) block (Dai-el[®] T530) while, the other one is based on PVDF blocks (Dai-el[®] T-630)³²⁷. A similar strategy has also been proposed by Ausimont (nowadays Solvay-Solexis) which markets Tecnoflon[®] block copolymers (Table 1) under a *pseudo*-living branching technology. Other fluorinated sequenced copolymers and TPEs using that process were reviewed a few years ago^{4,48}.

As a matter of fact, various models of multiblock copolymers containing VDF, trifluoroethylene and HFP were proposed from controlled step-wise (co)telomerization of fluoroolefins²²¹.

In addition, the synthesis of PVDF-b-polystyrene block copolymer³²⁸ was achieved by stepwise iodine transfer polymerization of VDF^{48,312,329} followed by that of styrene in the presence of PVDF-I. The thermal stabilities of these block copolymers were intermediate between those of polystyrene and of PVDF obtained under similar conditions.

On the other hand, various block copolymers have also been prepared from a pathway involving the *cleavage of the C-Br bond* (regarded stronger than the C-I one), and two processes have been used to prepare di- or triblock copolymers. The first one lies on the ATRP of styrene (Sty) *via* the bromine transfer³³⁰ from α,ω - \square -dibrominated intermediates 2 regarded as “macroinitiators”. Surprisingly, the authors claimed narrow polydispersity of 1.1 while previous similar investigations³²⁰ evidenced the presence of PVDF oligomers obtained by direct initiation from the radicals (generated from the initiator such as *ditert*-butyl peroxide) onto VDF. The dihalogenated compounds were prepared by telomerization of vinylidene fluoride with 1,2-dibromotetrafluoroethane³²³, as in Scheme 43.

INSERT SCHEME 43

Another example of synthesis³³¹ of diblock copolymers (4) deals with the *chlorine transfer* radical polymerization (*via* a CCl₃ end-group) of various M monomers (styrene, MMA, methyl acrylate and butyl acrylate) initiated by VDF telomers (3) with \overline{DP}_n ranging between 5 and 16, summarized in Scheme 44.

INSERT SCHEME 44

Interestingly, whatever the (VDF telomer; M) couple, the average molecular weights in number (\overline{M}_n) of 4 increased linearly with the monomer conversions and experimental values were close to the theoretical ones. In addition, narrow polydispersities ($\overline{M}_w / \overline{M}_n < 1.2$) were obtained. These statements are clear evidences of a controlled radical polymerization. Similarly, Shi and Holcroft³³² could prepare poly(VDF-co-HFP)-b-PS block copolymers by a first cotelomerization of VDF and HFP with chloroform followed by a similar ATRP of styrene. The sulfonation of these block copolymers led to poly(VDF-co-HFP)-b-PSSA block copolymers³³³ for fuel cell membranes. Small-angle neutron scattering and transmission electron microscopy were interesting tools for Rubatat *et al.*³³⁴ to study the correlation between the nanostructures and the transport properties of films cast from these diblock copolymers. Noteworthy, these membranes possess structures at two length scales: phase separation at length scale of ca, 40 nm arising from the immiscibility of both blocks and

substructure within the sulfonated polystyrene domains due to segregation of the hydrated ionic groups and the hydrophobic polystyrene chains.

More recently, that process was even successfully applied for the preparation of PVDF-*b*-poly(pentafluorostyrene)³³⁵ block copolymers by ATRP in the presence of CCl₃-PVDF. These original block copolymers are endowed with satisfactory thermostabilities. This survey completes an extensive review of the ATRP of pentafluorostyrene by Jankova and Hvilsted³¹³. (section 4.1.2). The nanostructure of film cast from these diblock copolymers was shown by the same group³³³ from small-angle neutron scattering and transmission electron microscopy.

More recently, PSSA-*b*-PVDF-*b*-PSSA and PSSA-*b*-poly(VDF-co-HFP)-*b*-PSSA triblock copolymers with various degrees of sulfonation (DS) have been synthesized by Xu *et al.*³³⁶ via a different approach. These A-B-A triblock copolymers were claimed to be obtained from telechelic PVDF (Mn = 56,000 g.mol⁻¹) or poly(VDF-co-HFP) copolymers (Mn= 32,000 g.mol⁻¹) as macroinitiators (see section 4.4), followed by ATRP of styrene, and finally after sulfonation (Scheme 45). However, no evidence of the end-group functionalities in R-PVDF-R or R-poly(VDF-co-HFP)-R intermediates worthing 2.00 was given. However, targeted molecular weights higher than 47,000 g.mol⁻¹ for PSSA-*b*-poly(VDF-co-HFP)-*b*-PSSA triblock copolymers were obtained enabling them to ensure essential mechanical properties for “durable and ductile films”.

These authors also noted that the Tg of the PS-*b*-PVDF-*b*-PS was 92 °C while it reached 134 °C when the PS blocks were sulfonated linked to the bulkyness of the sulfonate groups and the ionomer effect. Spectroscopic and thermal characterizations of the polymers were carried out just like tapping mode AFM and TEM which revealed self-assembled microstructures with tunable ionic domains or a microphase separation and ionic aggregates that depend strongly on the DS value³³⁶.

INSERT SCHEME 45

The hydrophilic ionic clusters coalesced into larger channel structures when DS > 23 %, coinciding with sharp increases of water uptake and proton conductivity. As expected, different DS ranging from 13 to 49 %) led to various ratios of average number of water molecules to sulfonic acid groups ($\lambda= 4-68$). The proton conductivity increased significantly when the ion-exchange capacity (IEC) increased from 0.5 to 1.5 mmol.g⁻¹ (Figure 32) and an optimal conductivity value of 0.091 S.cm⁻¹ was observed at 95 % RH and 30 °C for the membrane with a DS of 49 % (Figure 33). In addition, the copolymer membrane also showed

a maximum proton conductivity between 60 and 70 °C (Figure 34). Interestingly, the conductivities of the block copolymers are considerably higher than the random copolymers of polystyrene and sulfonated polystyrene possessing similar IEC³²⁶.

INSERT FIGURES 32-34

4.1.3. Conclusion

There are several pathways to prepare block copolymers based on PVDF (or poly(VDF-co-M) copolymer) sequences. The first series concerns the conventional radical polymerization including various alternatives from the radical telomerization to the condensation of phenate to Br-PVDF-Br. However, more opportunities can be offered by controlled radical copolymerizations of VDF with other fluorinated comonomers or with various M monomers (especially styrene) that have already led to interesting PVDF-b-poly(M) or polyM-b-PVDF-b-Poly(M) block copolymers. Suitable cleavable C-X bond can also be used in group or atom transfer. Indeed, two main industrial products have been already produced (Daiel® and Tecnoflon® marketed by Daikin and Solexis, respectively) for original thermoplastic elastomers, offering various products for many applications (gaskets, sealants, or medical items). A wide range of other block copolymers are recently potential candidates for fuel cell membranes. Nevertheless, the nowadays trends shows that there is an increasing interest on the controlled radical copolymerization of fluoroalkenes.

4.2. Fluorinated Graft Copolymers

4.2.1. Introduction

Five main synthetic ways of graft fluorinated copolymers are possible. They can be generated from i) the direct (co)polymerization of *macromonomers*, ii) from the *transfer to the polymer*, iii) from the *grafting of various polymers onto* a polymeric backbone, iv) from the *telomerization* of monomer(s) in the presence of *macrotelogen*, and finally v) from a macroinitiator or a macroradical (generated from an activated polymer) via the “*grafting from*” procedure (Scheme 46).

INSERT SCHEME 46

4.2.2. From Conventional Radical Copolymerization

The last pathway has already led to various investigations regarding the grafting (produced by the polymerization of various monomers such as acrylates or styrenics) onto activated fluoropolymers, as illustrated by Scheme 47. For example, activation onto PVDF can be realized by ozonization³³⁷⁻³³⁹, by high energy technologies such as gamma rays³⁴⁰, swift heavy ions³⁴¹, electron beam (EB)³⁴²⁻³⁴⁴, or plasma³⁴⁵.

Recently, an extensive review on the synthesis of fluorinated graft copolymers from radiografting of F-polymers has been reported³⁴⁶.

Hence, the activation of the polymer (in various states such as powders or films) leads either to trapped radicals or to macroinitiators, or, in certain cases, is accompanied by a simultaneous grafting of the monomer (Scheme 47).

INSERT SCHEME 47

Ozonization, which has been extensively summarized³³⁹, is an original means for activating polymers, though it has encountered slight difficulties when applied to PVDF. However, although under hard conditions, a few degradation was noted³³⁸. Nevertheless, the ozone pre-activated PVDF backbone led to macroinitiators containing mainly peroxides (90%) (titrated by diphenyl picryl hydrazyl or by iodometry³³⁸, and hydroperoxides (10%)³⁴⁷. The content of hydroperoxides was noted to decrease as the ozonization temperature was increased while the latter species were evidenced according to the method of Zeppenfeld³⁴⁸.

The second step concerns the grafting, in bulk, leading to a higher degree of grafting or in solution, of an oligomer or polymer based on MMA, styrene, glycidyl methacrylate (GMA), and acrylic acid (AAc). Kang's team³⁴⁹ also used that concept to prepare PVDF-g-PAAc graft copolymers (even achieving 100 % AAc grafting!)^{349b} for original microfiltration membranes with well-controlled pore sizes, uniform surface composition, and pH sensitive properties.

Nevertheless, in all cases, adapted experimental recipes were proposed to remove the corresponding homopolymers (that were obtained in ca. 40 % yield)³⁵⁰.

These produced PVDF-g-Poly(M) graft copolymers were tested in various applications. First, the mechanical behavior of the PVDF /PS blend was greatly improved by adding PVDF-g-PS copolymer, leading to a 2.5 fold increase in the break-stress for a 50/50 wt. % blend³⁵⁰. Second, the adhesion of PVDF to a glassy-epoxy composite was achieved by using PVDF-g-PAAc and PVDF-g-PGMA copolymers. In both cases, a great increase of the peeling strength was noted. Third, the introduction of hydrophilic groups (brought by acrylic acid, MMA, or GMA) enabled PVDF to be less hydrophobic³⁵⁰. Indeed, to improve surface hydrophilicity of PVDF, a large amount of work has been devoted to the surface modification of

fluoropolymers by chemical³⁵¹, plasma³⁵², irradiation³⁵³, corona discharge,³⁵⁴ flame,³⁵⁵ and vacuum ultraviolet radiation³⁵⁶. For example, the synthesis of PVDF-g-PMAAc (where MAAc stands for methacrylic acid) was reported in 1998 by Mascia and Hashim³⁵⁷ according to a two step-procedure, as in Scheme 48.

INSERT SCHEME 48

Furthermore, Liu *et al.*³⁵⁸ also used that strategy to synthesize PVDF-g-PEOMA graft copolymer, where PEOMA stands for polyethyleneglycol methacrylate. By phase inversion method, this group obtained nanoporous membranes endowed with interesting electrochemical properties for potential applications for Lithium ion rechargeable batteries: high liquid electrolyte uptake capacity, high conductivity ($1.6 \times 10^{-3} \text{ S.cm}^{-1}$ at 30 °C), a satisfactory transference number (0.15), and an electrochemical stability.

More recently, Danks *et al.*³⁵⁹ synthesized PVDF-g-PVBC graft copolymers from the activation of two grades of PVDF by γ -rays ^{60}Co followed by the grafting of vinyl benzyl chloride (VBC or chloromethylstyrene). According to the grade, the degree of grafting was either 38 or 54%, while the average thickness was 54 μm . Then, the chloromethyl end groups of the grafts underwent an amination reaction into benzyl trimethylammonium (BTMA) hydroxide³⁵⁹ or BTMA chloride (BTMAc)³⁶⁰ (Scheme 49) for anion exchange membrane applications.

INSERT SCHEME 49

The originality of the work lies on the ability of these quaternary ammonium side groups to conduct hydroxide ions in order to use this graft copolymer as novel membranes for alkaline fuel cells for portable applications. Unfortunately, this last step led to too brittle PVDF-g-PBTMAc graft copolymers because of degradation of the polymer backbone by the expected dehydrofluorination. Hence, the resulting materials which possessed lowered ion exchange capacity (IEC = 0.31 and 0.71 meq.g^{-1}) was unsuitable for use as membranes for fuel cells or electrochemical devices. Hence, these British authors decided to apply the same strategy from a perfluorinated copolymer, such as poly(TFE-co-HFP) or FEP copolymer which is not base-sensitive and they could obtain a membrane endowed with an IEC of 1.0 meq.g^{-1} .

Softer strategies were utilized in our Laboratory to graft phosphonated (meth)acrylates onto ozonized PVDF³⁶¹. Interestingly, phosphorous containing-(co)polymers³⁶² are endowed with

interesting properties such as fire proofing³⁶³, complexation, anticorrosion, and adhesion (especially from phosphonic acid function³⁶¹). Adhesion was advantageously taken into account for realizing a graft copolymer able to be applied onto galvanized steel³⁶¹. Indeed, these experiments show a neat improvement of the adhesive behavior of the PVDF coating compared to a similar copolymer containing carboxylic acid functions. Another property brought by the phosphonic acid function is the protonic conductivity and the resulting copolymers can be used in proton exchange membranes well-summarized in the excellent review of Lafitte and Jannasch³⁶². Such a growing interest-application has also attracted many scientists who have designed original graft copolymers for PEMFCs³⁶⁴. Indeed, various attempts of grafted PVDFs have also been investigated in that area to substitute perfluorosulfonic polymeric ones to compete with Nafion®. Among them, PVDF-g-PSSA graft copolymers has the advantages to be cheaper and less permeable to methanol than Nafion®, hence making better chances to provide a direct methanol fuel cell (DMFC) as shown by Saarinen *et al.*³⁶⁵.

The same group³⁶⁶ carried out the activation of PVDF (with doses of 25, 50, 100 and 200 kGy), the membranes were immediately immersed into neat styrene and kept for 0.5, 1, 2 and 4 h at room temperature under nitrogen³⁶⁶. As expected, it was observed that the higher the dose-rate and the longer the grafting-time, the higher the degree of grafting (d.o.g.).

Interestingly, the authors claimed that no homopolystyrene was formed. Then, the sulfonation of PVDF-g-PS membranes (in chlorosulfonic acid) led to degrees of sulfonation of 11-71%³⁶⁶. In these conditions, the authors did not observe any trace of chlorine atom in the polyvinylidene fluoride-graft-poly(styrene sulfonic acid) (PVDF-g-PSSA) membrane. This procedure is summarized by Scheme 50.

INSERT SCHEME 50

Further, Shen *et al.*³⁶⁷ used Al₂O₃ to produce a PVDF-g-PSSA composite with satisfactory conductivities while Horsfall's³⁶⁸ group used PVDF-g-PSSA graft copolymers for direct methanol fuel cells.

PVDF and poly(VDF-co-HFP) copolymers (which are hydrophobic) have been structurally modified by radiation grafting with styrene comonomers, and enable to link sulfonic groups. Copolymers were obtained by Soresi *et al.*³⁶⁹ who optimized the conditions of process, the energy of the radiation field (electrons, γ -rays), the absorbed dose, and the physico-chemical properties of the starting polymer (crystallinity degree, porosity, etc.). These Italian

researchers³⁶⁹ have reported the synthesis and the thermal, morphological, and electrochemical characterizations of proton-conducting polymers. Membranes obtained from the poly(VDF-co-HFP) copolymers (containing 5 mol. % HFP) and from common porous and dense PVDF homopolymer films were compared. High grafting degrees and water uptakes have been reached depending on the nature of the polymer matrix. Room temperature conductivities exceeding 60 mS.cm^{-1} at 90 % RH were observed in the case of the sulfonated membrane obtained from the PVDF-based copolymer.

A similar process was realized by Nasef *et al.*³⁷⁰ who prepared two classes of composite polymer electrolyte membranes, one conducting lithium ions (Li^+) and the other conducting protons H^+ . Porous PVDF films were impregnated with styrene and subjected to EB irradiation to obtain PS filled PVDF precursor films that were subsequently treated with either chlorosulfonic acid to obtain H^+ -conducting composite membranes or $\text{LiPH}_6/\text{EC}/\text{DEC}$ liquid electrolyte to obtain Li^+ -conducting composite membranes. The properties of the obtained membranes were found to achieve grafting content up to 46 % with superior Li^+ - and H^+ -conductivities of $1.91 \times 10^{-3} \text{ S.cm}^{-1}$ and $5.95 \times 10^{-2} \text{ S.cm}^{-1}$, respectively.

Chen *et al.*³⁷¹ synthesized and compared several electrolytes from radiografting process of different fluoropolymers (PTFE, ETFE, poly(tetrafluoroethylene-co-hexafluoropropene) copolymers (FEP), poly(vinyl fluoride) (PVF), and PVDF). First, they noted that PTFE and PVF were not suitable for the preparation of PEMFCs. In addition, membranes prepared from PVDF could not reach the same success as FEP or ETFE could since the resulting hydrogenated membranes were not chemically stable. Indeed, authors supplied the following decreasing order of the radiation degradation caused in the films:

PTFE > FEP > PFA > crosslinked PTFE > ETFE > PVDF > PVF.

Furthermore, PVDF had the best grafting ability among other fluoropolymers, for which the decreasing order was:

PVDF > PVF > ETFE > FEP > crosslinked PTFE > PFA > PTFE

These authors also showed that irradiated PVDF swelled easier in the monomer solution. PVDF-g-PSSA copolymers were achieved by grafting styrene onto a preirradiated PVDF membrane with a degree of grafting up to 87 %, followed by immersion into a chlorosulfonic acid solution, leading to a tough and flexible electrolyte. Maximum IEC value was 2.65 mmol.g^{-1} while the proton conductivity of the membrane was 0.085 S.cm^{-1} , though lower than those achieved from FEP ($\sigma = 0.117 \text{ S.cm}^{-1}$) or PFA ($\sigma = 0.095 \text{ S.cm}^{-1}$). Interestingly, comparing both conductivities from PVDF and ETFE isomers, the authors noted that the

membrane prepared from PDVF has a higher conductivity than that achieved from ETFE over the entire ion exchange capacity range. This arises from the higher crystallinity of PVDF arising from a higher sulfonic acid density in the amorphous region.

Though many surveys to synthesize graft copolymers containing PVDF from the above high energy beam method have been investigated, the presence of homopolymer and the control of the degree of grafting are still issues to overcome³⁷²⁻³⁷⁴.

Another alternative of synthesis of fluorinated graft copolymers (5) concerns the direct radical terpolymerization of VDF, HFP and an allylamido perfluoropolyethers (PFPE), as in Scheme 51³⁷⁵:

INSERT SCHEME 51

An interesting VDF-containing graft copolymer regarded as thermoplastic elastomer was discovered by the Central Glass Company¹⁴², and it is named Cefral Soft[®]. Its synthesis first involves the radical terpolymerization of VDF and CTFE with an olefinic peroxy carbonate (see section 3.2.1, Scheme 11), further leading to poly(VDF-co-CTFE)-g-PVDF graft copolymers via a “grafting from” procedure. Interestingly, Katoh *et al.*³⁷⁶ characterized the ¹⁹F NMR spectroscopy of these commercially available Cefral Soft[®] original graft copolymers.

4.2.3. From Controlled Radical Polymerization

Few fluorinated graft copolymers synthesized by controlled radical copolymerization have been reported in the literature, especially by the “grafting from” approach. To the best of our knowledge, nitroxide-mediated living free radical polymerization (NMP), reversible addition-fragmentation chain transfer (RAFT) polymerization, and ATRP are key strategies to prepare them.

The first one was successfully used by Holmberg *et al.*³⁷⁷ who prepared original PVDF membranes first irradiated by EB and then the free radicals formed were immediately quenched with 2,2,6,6-tetramethylpiperidinyl-1-oxy (TEMPO). In the second step, the produced TEMPO-capped macroinitiator sites were utilized in the controlled graft copolymerization of styrene *via* NMP. After sulfonation of the PS grafts, the resulting PVDF-g-PSSA membranes were compared to those obtained from the conventional preirradiation grafting method. Noteworthy is the fact that the membranes using the controlled grafting

technique are grafted through the membrane already at a degree of grafting of 14 %, whereas the penetration limit for the membranes prepared by conventional radiation-induced grafting is ca. 30%. Preliminary H₂/O₂ fuel cell tests showed promise results from PVDF membrane grafted by means of NMP in contrast to those obtained by conventional preirradiation grafting. Indeed, the former one could be used in a fuel cell for 930 hrs at 70 °C without any drop in current density while the latter ones failed within 150 to 200 hrs under similar conditions.

Another “controlled” strategy was claimed by Chen et al.³⁷⁸ for the synthesis of original PVDF-g-PMMA and PVDF-g-PPEGMA graft copolymers (where PEGMA stands for poly(ethylene glycol) monomethacrylate) from the RAFT polymerization of MMA and PEGMA at the PVDF surfaces. First, PVDF surfaces were exposed to aqueous LiOH, followed by successive reduction with NaBH₄ and DIBAL-H to obtain hydroxyl functionality. Azo-functionalities, as surface initiators for grafting, were further immobilized on the PVDF surfaces by esterification of 4,4'-azobis(4-cyanopentanoic acid) and the surface hydroxyl groups. The chemical composition and surface topography of the surface of these graft copolymers were characterized by XPS, FTIR spectroscopy, and AFM. The authors noted a linear increase in the graft concentration of PMMA and PPEGMA with time, indicating that the chain growth from the surface was consistent with a "controlled" process.

Kang's team³⁷⁹ also used that strategy from ozone-pretreated PVDF which further could react with 1-phenylethyl dithiobenzoate enabling to get PVDF bearing various pending dithioester side groups. These latter allowed the controlled radical polymerization of acrylic acid (AAc) to obtain PVDF-g-PAAc (claiming “living PAAc graft chains on the surface”) for the preparation of microfiltration membranes. Furthermore, the PVDF-g-PAA membrane was functionalized in a subsequent surface-initiated block copolymerization with N-isopropylacrylamide (NIPAAM) and the resulting PVDF-g-PAA-b-PNIPAAM membranes exhibited both pH- and temperature-dependant permeability for aqueous solutions.

The “grafting from” method based on ATRP technique has also been widely used as an efficient polymerization for preparing well-defined graft copolymers³⁸⁰⁻³⁸⁴. Several non-exhaustive examples of F-graft copolymers designed from the specific cleavage of C-X bond (where X represents a halogen) *via* ATRP are given below. Indeed, various investigations dealing with ATRP to introduce PS, further sulfonated into PSSA, have been successfully achieved and various authors have been inspired to prepare PVDF-g-PSSA from that strategy.

4.2.3.1. from the C-Cl cleavage

As mentioned above, Sundholm's group³⁸⁰ performed the synthesis of PVDF-g-PVBC graft copolymers where VBC stands for vinyl benzyl chloride according to the same strategy (Scheme 52).

INSERT SCHEME 52

These PVDF-g-PVBC copolymers acted as suitable macroinitiators via their chloromethyl side groups in the ATRP of styrene with the copper bromide/bipyridine catalytic system leading to controlled PVDF-g-[PVBC-g-PS] graft copolymers, as in Scheme 53.

INSERT SCHEME 53

The degree of styrene grafting increased linearly with time, hence indicating first-order kinetics, regardless of the polymerization temperature, and it reached 400% after 3 hr at 120°C³⁸⁰. As a matter of fact, such a high degree of grafting (d.o.g.) could not be possible with conventional uncontrolled radiation-induced grafting methods because of termination reactions. The polystyrene grafts were sulfonated hence leading to well-architected PVDF-g-[PVBC-g-PSSA] graft copolymers for designing of proton-exchange membranes for fuel cells applications with highest conductivity of 70 mS.cm⁻¹.

In another approach and surprisingly, Zhang and Russell³⁸¹ prepared PVDF-g-PS and PVDF-g-PBuA graft copolymers (where BuA means butyl acrylate) from ATRP of styrene (or BuA) when a poly(VDF-co-CTFE) random copolymers was used as the initiator. The authors claimed that the grafting was achieved from the cleavage of the C-Cl bond of CTFE, though regarded as quite stable! They could obtain poly(VDF-co-CTFE)-g-PS and poly(VDF-co-CTFE)-g-Poly(*t*BuA) graft copolymers that had molecular weights up to 250,000 g/mol. Surprisingly, no spectroscopic evidence was supplied in that article.

This was also claimed by Kim's group³⁸² which synthesized proton conducting poly(VDF-co-CTFE)-g-PSSA graft copolymers in a similar "grafting from" method using an ATRP process. Unfortunately, the ¹H NMR spectra of poly(VDF-co-CTFE)-g-PSSNa were not convincing and the publication lacks of both the SEC chromatograms and of ¹⁹F NMR spectra; in addition, the controlled of the polymerization was not evidenced. Nevertheless, these Korean authors characterized the microphase-separated structure of the polymer electrolyte membranes and showed that the ion exchange capacity, the water uptake and the proton conductivity of the resulting membranes continuously increased with the increased of the

PSSA content. These membranes were advantageously UV crosslinked after the chlorine dangling atoms were converted into azido group and hence could exhibit a reduced water uptake from 300 % to 83 % but better mechanical properties but the conductivity values slightly decreased from 0.074 to 0.068 S.cm⁻¹ at room temperature.

In addition, Holdcroft's team³³³ synthesized PVDF-g-PSSA and poly(VDF-co-HFP)-b-PSSA copolymers of different molecular and equivalent weights, and compared the morphologies (i.e., the nanoarchitectures) and the electrochemical properties of the resulting membranes prepared therefrom. TEM pictures revealed different morphologies between both structures playing a major role for the understanding of the swelling, conductivities, and effective proton mobility through the membrane *versus* IEC. These authors noted that the graft membranes possess a significant higher percolation threshold than the diblock membranes (*ca.* 1.0-1.2 mmol.g⁻¹ for grafts, and *ca.* 0.6 mmol.g⁻¹ for diblocks) which correlate with water uptakes. Comparing the “in-plane” to “through-plane” proton conductivities (the latter is relevant to proton conduction in fuel cells) show different results for the obtained membranes produced from both these types of designed structures: i) the proton conductivity assessed from the first method for the diblock membrane was found to be *ca.* 2.4 times greater than “through-plane” conductivity indicating a mild degree of anisotropy; ii) in contrast, the graft membranes had very similar “in-plane” and “through-plane” proton conductivity (anisotropy = 0.95). As a reference, these Canadian authors determined the conductivity anisotropy of Nafion®112 membrane of *ca.* 1.4.

4.2.3.2. from the C-Br cleavage

To our knowledge, only one survey reports the synthesis of graft copolymers from an initiator that contains a C-Br cleavable bond. Actually, the chemical modification of poly(VDF-co-BDFO) copolymers³⁸³, synthesized by conventional radical copolymerization of VDF with 4-bromo-3,3,4,4-tetrafluorobut-1-ene (BDFO)²²⁷, was successfully achieved by ATRP of styrene catalyzed by CuBr and 1,1,4,7,10,10-hexamethyltriethylenetetramine (HMTETA) as the ligand (Scheme 54).

INSERT SCHEME 54

Interestingly, the linear molar masses of the produced PVDF-g-PS graft copolymers *versus* the styrene conversion relationship (Figure 35) and narrow polydispersity indices (starting from 1.8 for poly(VDF-co-BDFO) random copolymers) evidence a controlled behavior of that graft copolymerization³⁸³.

INSERT FIGURE 35

4.2.3.3. from the C-F cleavage

Surprisingly, ATRP of methacrylates was reported to be successful from the cleavage of the C-F bond in PVDF to produce PVDF-g-poly(methacrylates)³⁸⁴ graft copolymers, though no significant spectroscopic evidences have been brought by the authors. Indeed, if that grafting occurs, it can be anticipated that it arises rather from the cleavage of the less stable C-H in methylene and not in the more stable difluoromethylene of VDF as claimed by these authors. Indeed, it is well-known that the chemical resistance of PVDF is not as broad as that exhibited by perfluoropolymers because the somewhat acidic hydrogen atoms along the chain are reactive in strongly basic media, leading to the formation of fluoride salts by-products.

Mayes *et al.*³⁸⁵ claimed the synthesis PVDF-g-PPEOMA graft copolymers by ATRP of poly(ethylene oxide) monomethacrylate from PVDF. Although this synthesis is quite surprising for the same reasons as above, the authors mentioned that these comb polymers were used for water filtration in which the hydrophilic domains could provide a pathway for water transport.

Nevertheless, this above strategy was also used recently by a Korean group³⁸⁶ which synthesized PVDF-g-PSSA and PVDF-g-PSPMA graft copolymers (where PSPMA stands for poly(sulfopropylmethacrylate) after 48 hrs at 120 °C with maximum successful degrees of grafting of 25 wt. % and 35 wt. %, respectively. The ionic exchange capacity values, water uptakes and proton conductivities were 0.45 and 0.63 meq.g⁻¹, 33.4 and 46.8 wt. %, and 0.007 and 0.015 mS.cm⁻¹, respectively. However, neither the ¹⁹F NMR spectra nor the SEC chromatograms were provided, and the ¹H NMR spectra were not convincing especially because of the intense signals assigned to the high amount of solvent and an unexpected broad signal was observed instead of characteristic quintet centered at 2.9 ppm assigned to methylenes of VDF.

4.3. Fluorinated Alternating Copolymers

Although VDF does not copolymerize with vinyl ethers as CTFE, 1,1-dichlorodifluoroethylene, perfluoroacrylonitrile or TFE do, it is able to produce alternating copolymers, with hexafluoroisobutylene^{296,297}, hexafluoroacetone¹⁹², methyl trifluoroacrylate^{275,276} or α -trifluoromethacrylic acid^{191,315}. The first one is produced by the

Allied Company under the CM1[®] trade name, nowadays marketed by Honeywell International Ltd..

4.4. Telechelics containing VDF base-units

4.4.1. *Telechelics from functional initiators*

More than 35 years ago, fluorinated telechelic peresters³⁸⁷⁻³⁸⁹, synthesized by the oxidation of fluorinated acid chlorides or by the direct addition of acid fluorides to hydrogen peroxide, were successfully used by Rice and Sandberg for initiating the copolymerization of VDF and HFP under dead end copolymerization (DEP) leading to original fluoroelastomers³⁸⁹ (Scheme 55).

INSERT SCHEME 55

The average molecular weight determined by vapor pressure osmometry was ca. 4,000 g.mol⁻¹. While propagation of monomers occurs in a classical way, termination step proceeds by recombination, only.

More recently, in a similar DEP strategy, original telechelic poly(VDF-co-CTFE) copolymers were synthesized by the radical copolymerization of VDF and CTFE initiated by various aroyl peroxides³⁹⁰ (Scheme 56).

INSERT SCHEME 56

Molecular weights were 48,000 or 56,000 g.mol⁻¹ and PDI = 1.5-1.6. However, no evidence of a functionality of 2.00 was supplied.

Hybrid materials from these telechelic copolymers³⁹⁰ and oleic acid-capped titanium oxide (TiO₂) nanoparticles were prepared into uniform films which showed a good thermal stability (withstanding 200 °C for 14 hrs without any significant changes).

Hydrogen peroxide was also used to prepare novel α,ω -dihydroxylated poly(VDF-co-HFP) cooligomers of low molecular-weights (800-3,000 g.mol⁻¹) in a two step-procedure³⁹¹ (Scheme 57 where G designates CH₂OH or CO₂H).

INSERT SCHEME 57

A similar strategy was used for the preparation of telechelic oligoVDFs from the photo-induced dead end polymerization of VDF in the presence of hydrogen peroxide³⁹².

4.4.2 Telechelics from Fluorinated Telomers Based on VDF

Obviously, the use of chain transfer agent enables one to obtain lower molecular weights and, according to the nature of this reactant, functional compounds can be produced or a better control of the copolymerization can be achieved. According to the amount and of the transfer-efficiency of such a reagent, conditions of telomerization⁴ can be achieved. Such a reaction represents a very interesting model of (co)polymerization since it leads to low-molecular weight polymers with well-defined end-groups. A quasi-exhaustive list of chain transfer agents used in the telomerization of main fluoroalkenes was previously reported⁴. α,ω -Diiodo $I(TFE)_x(VDF)_y(HFP)_zI$ telomers were synthesized and then functionalized into telechelic non-conjugated dienes³⁹³. These latters were hydrosilylated with fluorohydrogenosilanes to produce fluorinated dichlorosilanes, hydrolyzed into disilanol. The condensation of these disilanol or their copolycondensation with the dichlorosilanes led to hybrid fluorosilicones endowed with improved thermostability, and exhibit the structures³⁹⁴⁻³⁹⁶ (Scheme 58).

INSERT SCHEME 58

A first series was achieved by researchers at the Dow Corning Corp.³⁹⁴, from TFE telomers, while later, our Laboratory supplied novel hybrid fluorosilicones based on fluorinated telomers containing VDF, TFE and HFP base units³⁹⁵⁻³⁹⁷. The fluoropolymers are rather stable in a wide range of temperatures, interesting low T_g s were reached ($T_g \sim -40$ °C) and satisfactory thermal stability ($T_{dec} = 400$ °C). Their structures are similar to that above with $n = 2$ or 3 ; $R_1, R_2 : CH_3, C_2H_4CF_3$ or $C_2H_4C_4F_9$ and $R_F : (VDF)_a (TFE)_b (HFP)_c$ with $a = 0,1$; $b = 2,3$; $c = 0,1$. More information on these hybrid F-silicones has been reviewed^{398,399}.

4.5. Chemical Modification of PVDF and VDF-Containing Copolymers

Although mentioned in section 4.2, the chemical modification of PVDF or of VDF-containing copolymers have already led to numerous grafted copolymers bearing long chain grafts *via* the “grafting from” route. This section considers only slight chemical modifications with short chain length-groups.

Another survey related to fuel cell membranes was suggested by Chung *et al.*¹³⁸. The strategy to obtain poly(VDF-co-CTFE) copolymers was mentioned in section 3.2.1 (Scheme 8) from the radical terpolymerization of VDF with $F_2C=CF-R-Si(CH_3)_2OR$ (R being an alkyl group)

and CTFE in the presence of borinate. Then, the grafting of an aryl trialkoxysilane containing a sulfonyl chloride occurred via the hydrolysis condensation between both trialkoxysilane of the poly(VDF-co-CTFE) copolymer and the aryl sulfonyl chloride reactant (Scheme 9).

Another investigation involving the chemical modification of VDF-containing copolymers (produced from the radical terpolymerization of VDF with HFP and α -trifluoromethacrylic acid (MAF)^{191,400}) yielded original materials bearing para-benzene sulfonic acid side groups, as potential fuel cell membranes (the conductivities of which were ca. 0.020 S.cm^{-1})⁴⁰¹, as depicted in Scheme 59. Prior to chemical modification it was noted that the higher the MAF contents in the poly(VDF-ter-HFP-ter-MAF) terpolymers (ranging from 1 to 44 mol. %)⁴⁰⁰, the worse the thermal stability due to the decarboxylation of CO_2H functions.

INSERT SCHEME 59

More attractive membranes have been obtained from route 2 to avoid the presence of ester group as weak point.

In addition, another original procedure to prepare fuel cell membranes consists in grafting an amino sulfonated synthon (prepared by radical addition of a mercaptoethylamine hydrochloride onto styrene sodium sulfonate in water)⁴⁰² onto commercially available poly(VDF-co-HFP) copolymers. Such a grafting shows the classic mechanism of grafting of amines onto VDF-HFP diad¹⁰ in three steps (Scheme 60) and confirmed model reactions⁴⁰³. Molar percentages of grafted telomer were assessed by ^1H NMR spectroscopy and by elemental analysis, hence leading to the ionic exchange capacity. Though the conductivities were lower than that of Nafion117[®], they increased with the IEC. The produced membranes started to decompose from $170 \text{ }^\circ\text{C}$ under severe conditions⁴⁰².

Another alternative to modify poly(VDF-co-HFP) copolymers lies on the grafting of parasulfonic phenolate leading to original modified copolymers bearing sulfonic acid group also showing some protonic conductivity⁴⁰⁴.

INSERT SCHEME 60

The Arkema company⁴⁰⁵ has recently claimed the grafting of 2 wt. % maleic anhydride onto a poly(VDF-co-HFP) copolymer (containing 16 wt.% HFP) by radiation-grafting, leading to an original copolymer with the following characteristics: a crystallization temperature of $103 \text{ }^\circ\text{C}$;

a threshold strength of 18 MPa and a viscosity in the molten state of 900 Pa.s. Such modified fluoropolymers exhibit improved adhesion to thermoplastics, elastomers or inorganic materials in multilayer systems.

4.6. Conclusion

There are many strategies to synthesize well-designed fluoropolymers, either by conventional or controlled radical (co)polymerization. Though VDF-copolymers have not found potential applications in optics (because of the presence of both hydrogen atoms in VDF units) such well-architected copolymers containing VDF can be used in many other fields. For compared applications, six main types can be distinguished:

i) for *thermoplastic elastomers* involved in seals, gaskets, and O-rings applications, Cefral® and Dai-el® (just like Tecnoflon®) are three commercially available products marketed by Central Glass and Daikin (and Solvay Solexis), exhibiting graft and block structures, respectively;

ii) for *surfactant* applications, though few designed molecules have already been obtained, it is expected that more and more compounds can be synthesized since the methylene groups of VDF units in the oligo(VDF) groups or microblock can be either metabolized or enzymatically cleaved, hence leading to non-biodegradable products as interesting alternatives to PFOA and PFOS surfactants;

iii) in the field of *membranes*, various approaches have led to different types of membranes (mainly for microfiltration³⁷⁹ or for fuel cell) from block or graft copolymers. First, Xu *et al.*³³⁶ noted that the conductivities of the block copolymers are considerably higher than the random copolymers of polystyrene and sulfonated polystyrene possessing similar IEC. In addition, the membranes obtained from preirradiated PVDF or poly(VDF-co-HFP) copolymers followed by grafting PS (further sulfonated into PSSA) were not chemically stable. However, under NMP of styrene of irradiated PVDF membranes quenched with TEMPO, better electrochemical properties³⁷⁷ and thermal stability were noted. Holdcroft's team³³³ compared the potential of PVDF-g-PSSA and poly(VDF-co-HFP)-b-PSSA copolymers and the electrochemical properties of the resulting membranes. These authors noted that the graft membranes possess a significant higher percolation threshold than the diblock membranes and this statement correlates with water uptake values. This is in good agreement with specific micro- or nanostructures such as lamellae or, better, in giroids as reported in a review⁴⁰⁶.

iv) for *rechargeable lithium ion batteries*, quite a few works have been proposed, besides Liu *et al.*³⁵⁸ who prepared nanoporous membranes endowed with satisfactory electrochemical properties from PVDF-g-PEOMA graft copolymers.

v) for *coatings*, to our knowledge, almost neither block nor graft copolymers containing VDF have already been achieved but random and PVDF/PMMA blends are well-established products, Kynar® being a valuable example;

vi) from *telechelics* containing VDF for possible thermostable polymers, except few hybrid fluorosilicones, neither polycondensates (polyesters, polyamides, and polyimides) nor polymers resulting from polyaddition have ever been synthesized;

5. APPLICATIONS OF FLUOROPOLYMERS BASED ON VINYLIDENE FLUORIDE

The above sections have already mentioned that PVDF and poly(VDF-co-M) copolymers find extensive use in a wide range of products. PVDF homopolymers can find many applications which are well-documented in various reviews^{5,9}. Among them, can be found:

1) Paints and coatings: for example, binders for long lasting weather resistant finishes for metals; decorative films for lamination to surfaces; automotive trim applications; aircraft interior surface in-mold lining processing; resistance to weather and chemicals (chlorine and bromine for example⁴⁰⁷); primer coating; and corrosion resistant coatings tank liners;

2) Chemical processing equipment: flexible tubings for deep sea oil transport, packing for distillation towers; high purity water systems; piping for chemicals; pumps and instrument parts; fuel handling systems including underground storage tank systems and automotive fuel lines;

3) electrical and electronic devices: jacketing of cables for plenum areas including signaling, communication, and power lines; insulating compounds for jacketing wires and cable assemblies; cathodic protection; industrial power control systems; high temperature wiring; wires and cables sheathing;

4) specialty applications: microporous membranes, toners (PVDF is an essential ingredient at low levels in almost all commercially available toners for photocopiers and many laser printers); fishing lines and nets; musical strings; processing aid for polyolefins; monofilament and fabrics used in filtering wood pulp during bleaching; lithium ion batteries; electrodes binders; piezo and pyroelectric transducers for motion sensors; hydrophones, audio

devices, supercapacitors, electrolytic capacitors, aircraft interior sound control; jet engine fan blades, or biomedical applications such as suture wires.

Thermoplastics poly(VDF-co-M) copolymers have found applications in coatings and membranes while fluoroelastomers are developed for use as fuel tank hatch and joint sealants, fuel vapour seals, and O-rings for hydraulic systems in aircraft and aerospace applications. Fluoroelastomers are now widely used in the industry as O-rings, V-rings, gaskets and other types of static and dynamic seals, as diaphragms, valve seals, hoses, coated cloth, shaft seals^{5-8,11}, expansion joints, etc. They are also used in cars as O-rings for fuel and shaft seals and other components of fuel and transmission systems^{5-8,11}.

Commercial applications of fluoroelastomers reflect their rather special combination of properties: excellent resistance to heat, fluids, oxidizing media combined with good physical properties.

Energy-consuming industries, automotive, military aircraft and petrochemical industries require fluoropolymers for sealants, gaskets, O-rings, and lining resistant to corrosive materials.

Aerospace propellant systems often utilize very aggressive fuels and oxidizers, which are incompatible with all currently available elastomers, including fluoroelastomers. FFKM[®] are often used in these systems due to their oxidative stability and compatibility with both oxidizers and hydrazine-type fuels.

Fire-resistant lubricants containing phosphate esters and lubrication oils-containing amines are both interesting applications where the use of FFKM[®] greatly extends seal life.

FFKM[®] are the most suitable materials available for use in semiconductor processing equipment. In these applications, the elastomer comes in direct contact with dry process chemicals and reactive plasmas. The elastomer is typically exposed to aggressive wet chemical environments such as sulfuric acid / hydrogen peroxide or ammonium hydroxide / hydrogen peroxide / ultra pure deionized water mixtures.

Although discovered more than 35 years ago, perfluoroelastomers represent a production of several tons a year. However, they are growing at a fast pace in terms of applications and introduction of new composition to meet industrial needs. Perfluoroelastomers represent less than 1% of the total fluoroelastomers field, dominated by VDF-base copolymers.

It is expected that new fluoropolymeric materials and new curing chemistry will be developed in the future, due to continued escalation at severe service conditions and improvements in broad temperature damping characteristics and low temperature resilience. Blends of

fluoropolymers with other polymers, and recyclability features will also contribute to their continuing success in many engineering and aggressive service environments.

6. CONCLUSION

Vinylidene fluoride is a versatile, non-toxic, environmental friendly gaseous monomer that can be easily homopolymerized (its propagation rate to the square root of termination rate is $0.14 \text{ L}^{0.5} \cdot \text{mol}^{-0.5} \cdot \text{s}^{-0.5}$ at $74 \text{ }^\circ\text{C}$ in solution and $1.3\text{-}2.23 \text{ L}^{0.5} \cdot \text{mol}^{-0.5} \cdot \text{s}^{-0.5}$ at $120 \text{ }^\circ\text{C}$ in sc CO_2 , and can also (co)polymerized in the presence of radicals leading to thermoplastics, elastomers or thermoplastic elastomers. PVDF and poly(VDF-co-M) copolymers can find many applications in a wide range of areas such as energy (fuel cell membranes, lithium ion batteries, dye sensitized solar cells, actuators); aerospace, aeronautics and automotive industries (e.g., elastomeric sealants, O-rings, gaskets which are resistant to low and high temperature and in aggressive media), microfiltration and ultrafiltration membranes, blends, composites (even with nanofillers). Hence, a wide variety of (co)polymers can be prepared, most of them being random (except for VDF/hexafluoroisobutylene, VDF/methyl trifluoroacrylate and VDF/ α -trifluoromethacrylic acid that are alternating). Conventional radical copolymerization has traditionally led to a wide variety of poly(VDF-co-M) copolymers while academic investigations led to the kinetics of copolymerization of VDF with M monomers. More recently, iodine transfer copolymerization or other controlled radical copolymerization VDF M monomers and in the presence of fluoriodides or xanthates chain transfer agents. Moreover, certain VDF-containing polymers can be regarded as well-architected polymers. Among them, and besides the above alternating copolymers, three categories can be proposed: i) block copolymers are prepared under conventional or more recent controlled radical polymerization methods. In these last cases, PVDF-X acts as original initiator especially in halogen (X stands for chlorine, bromine, and iodine atom) transfer radical polymerization; ii) graft copolymers can be achieved from direct co-(or ter-) polymerization or from the polymerization of monomers in the presence of macroinitiators produced from the activation of fluoropolymers (e.g., from ozone, electron-beam, swift heavy ions or gamma rays) ; iii) telechelics are obtained either from the radical (co)polymerization of fluoroalkenes (including VDF) in the presence of functional initiators (telechelic preesters or hydrogen peroxide), or from telomerization of fluoroalkenes with adequate chain transfer agents.

In addition, thermoplastic elastomers are easily made and are versatile materials containing both soft and hard segments. Interestingly, various combinations of synthetic block microstructures are possible based on the comonomers involved in the different blocks to

achieve both thermoplastic or elastomeric segments, and hence to reach suitable T_g s and T_m s. Various strategies applied by Daikin, Dupont Performance Elastomers and Solvay Solexis have led to commercially available block copolymers, regarded as the first ones produced in an industrial scale. However, lowering their T_g s is still a challenge, which is inherent to the T_g of the elastomeric block always higher than $-33\text{ }^\circ\text{C}$ (although the 3M company recently produced an original statistic cross-linkable terpolymer endowed with a T_g of $-40\text{ }^\circ\text{C}$ ⁴⁰⁸). Nevertheless, many applications of these TPEs have been found in civil and engineering materials such as hot melts, gaskets, O-rings, diaphragms of pumps, pressure sensitive additives, medical contact lenses, electronic chemical items, coatings for food industries, and other devices involved in high-tech industries. More recently, block and graft copolymers based on VDF have been designed as membranes for fuel cells.

However, limitations still exist. Adequate cure site comonomers for the copolymerization of VDF are still searched and should be expected to enable one to go to a further generation of crosslinked thermoplastic or fluoroelastomers. In addition, VDF-containing polymers stable to bases or alkalis are scarce and claimed in a few patents. This offers additional chances to a technology that already forms the basis of the commercial production of classes of chemicals, which are among the most advanced and successful products in fluorine chemistry.

Hence, further challenges deserve to be explored and should attract the interest of industrial or academic researchers.

7. LIST of SYMBOLS and ABBREVIATIONS

AIBN	α,α' -Azobisisobutyronitrile
ATRP	<i>Atom transfer radical polymerization</i>
BPO	<i>Dibenzoyl peroxide</i>
C_{ex}	<i>Exchange constant</i>
CTA	<i>Chain transfer agent</i>
CRP	<i>Controlled radical polymerization</i>
CSM	<i>Cured site monomer</i>
CTFE	<i>Chlorotrifluoroethylene</i>
DMF	<i>Dimethyl formamide</i>

DMFC	<i>Direct methanol fuel cell</i>
DP_n	<i>Number average degree of polymerization</i>
DS	<i>Degree of sulfonation</i>
DSC	<i>Differential scanning calorimetry</i>
DSSC	<i>Dye Sensitive Solar Cell</i>
DT	<i>Degenerative transfer</i>
DTBP	<i>Ditert-butyl peroxide</i>
E	<i>Ethylene</i>
EB	<i>Electron Beam</i>
GPC	<i>Gel permeation chromatography</i>
HFIB	<i>Hexafluoroisobutylene</i>
HFP	<i>Hexafluoropropylene</i>
IR_FI	<i>α, ω-Diodoperfluoroalkane</i>
ITP	<i>Iodine transfer polymerization</i>
CRP	<i>Controlled radical polymerization</i>
M	<i>Monomer (or comonomer)</i>
MADIX	<i>Macromolecular design through interchange of Xanthates</i>
MAF	<i>α-trifluoromethacrylic acid</i>
MEA	<i>Membrane electrode assembly</i>
M_n	<i>Number average molecular weight</i>
M_w	<i>Weight average molecular weight</i>
LCB	<i>Long chain branching</i>
NMP	<i>Nitroxide-mediated polymerization</i>
NMR	<i>Nuclear magnetic resonance</i>
P	<i>Propylene</i>

PAAVE	<i>Perfluoroalkoxyalkyl vinyl ether</i>
PAVE	<i>Perfluoroalkyl vinyl ether</i>
PDI	<i>Polydispersity index</i>
PEMFC	<i>Proton exchange membrane fuel cell</i>
PEO	<i>Polyethylene oxide</i>
PFOA	<i>Perfluorooctanoic acid</i>
PFOS	<i>Perfluorooctane sulfonic acid</i>
PFPP	<i>Pentafluoropropylene</i>
PMMA	<i>Poly(methyl methacrylate)</i>
PMVE	<i>Perfluoromethyl vinyl ether</i>
PSSA	<i>Poly(styrene sulfonic acid)</i>
PTFE	<i>Poly(tetrafluoroethylene)</i>
PVDF	<i>Poly(vinylidene fluoride)</i>
R	<i>Alkyl group</i>
RH	<i>Relative humidity</i>
RAFT	<i>Reversible addition-fragmentation chain transfer polymerization</i>
R_F	<i>Perfluorinated group</i>
R_FI	<i>Perfluoroalkyl iodide</i>
SEC	<i>Size exclusion chromatography</i>
SEM	<i>Scanning electron microscopy</i>
Semi-IPN	<i>Semi-interpenetrated polymer network</i>
S	<i>Styrene</i>
TEM	<i>Transmission electron microscopy</i>
TFE	<i>Tetrafluoroethylene</i>
TFP	<i>3,3,3-Trifluoropropene</i>

T_g	<i>Glass transition temperature</i>
TPE	<i>Thermoplastic elastomer</i>
TrFE	<i>Trifluoroethylene</i>
VAc	<i>Vinyl Acetate</i>
VDF	<i>Vinylidene fluoride (or 1,1-difluoroethylene)</i>
Δ	<i>Heating</i>

8. ACKNOWLEDGEMENTS

The author thanks Professors Boutevin and Kostov for their stimulating inputs. Post-doc researchers and PhD students (mentioned as co-authors in the list of references, and who are now doctors!) are thanked for their contributions. Industrial colleagues are also granted for fruitful discussions and their companies (Arkema, CEA, DuPont Performance Elastomers, Dyneon, Great Lakes-Chemtura, Hydro-Quebec, Solvay, and Tosoh F-Tech) are acknowledged too for sponsoring various studies and/or supplying free samples, and also the European Commission (European Programme Portapower ENK5-2002-00669). The author also thanks Dr Ph. Wormald for supplying the ¹⁹F solid state NMR of PVDF (Figure 1).

9. REFERENCES and NOTES

- 1 a) Wall, L.A.; *Fluoropolymers*, **1972**, Wiley Interscience, New-York; b) Feiring, A.E. *Fluoroplastics* in : *Organofluorine Chemistry : Principles and Commercial Applications* (Banks, R.E.; Smart, B.E.; Tatlow, J.C. eds), **1994**, Plenum Press, New-York, Chapt. 15, 339-372.; c) Willoughby, B.G.; Banks, R.E. “ *Fluoropolymers* ” in : *Encycl. Adv. Materials*, (Bloor, B.G.; Brook, R.J.; Flemings, M.C.; Mahajan, S.; Cahn, R.W., eds), **1994**, Pergamon, Oxford, 887-895.
- 2 Scheirs, J.; *Modern Fluoropolymers*, **1997**, Wiley, New-York.
- 3 Hougham, G.; Cassidy, P.E.; Johns, K.; Davidson, J.; *Fluoropolymers : Synthesis and Applications*, **1999**; Vol. 1 and 2, Plenum Publish., New-York.
- 4 Ameduri, B.; Boutevin, B.; *Well Architected Fluoropolymers: Synthesis, Properties and Applications*; **2004**, Elsevier, Amsterdam.

- 5 Moore A. L.; *Fluoroelastomers Handbook; the Definitive User's Guide and Data Book*; **2006**; Plastic Design Library; William Andrew Publishing, Norwich (New York, USA).
- 6 Logothetis, A.L.; *Prog. Polym. Sc.*, **1989**, *14*, 251.
- 7 a) Lynn, M.M.; Worm, A.T.; *Rapra Review Reports*, **1995**, *Vol. 3*, Report 32, 1-27, Shrewsbury; b) Sokolov, S. V.; Kolokol'tseva, I.G.; *Polym. Sci. Ser. A*, **1996**, *38*, 225 (translated from *Vysokomol. Soedin*, **1996**, *38*, 400).
- 8 Ameduri, B.; Boutevin, B.; Kostov, G.; *Prog. Polym. Sc.*, **2001**, *26*, 105.
- 9 a) Seiler, D.A.; "PVDF in the Chemical Process Industry" in *Modern Fluoropolymers* (Scheirs, J. ed.), **1997**, Chapter 25, 487-506, Wiley New-York; b) Humphrey, J. S.; Amin-Sanayei, R.; "Vinylidene Fluoride Polymers"; In Mark, H. F., Ed.; *Encyclop. Polym. Sci. Techn.*, 3rd ed.; **2004**, Wiley; New York, Vol. 4, pp 510–533.
- 10 Taguet, A.; Ameduri, B.; Boutevin, B.; *Adv. Polym. Sci.* **2005**, *184*, 127.
- 11 a) Van Cleeff, A.; *Kautsch Gummi Kunstst*, **1986**, *39*, 196; b) Van Cleeff, A.; Fluoroelastomers in *Modern Fluoropolymers* (Scheirs, J. Ed.); **1997**; Chapter 13, pp.257-270 Wiley, New-York.
- 12 Ford, T. A.; US patent 2,468,054 **1948** (assigned to DuPont).
- 13 a) Dohany, J.E.; Humphrey, J.S.; *Vinylidene Fluoride Polymers* in : *Encycl. Polym. Sci. Eng.* (Mark, H.F.; Bikales, N.M.; Overberger, C.G.; Menges, G., eds.), **1989**, *17*, 532-548, Wiley, New-York; b) Dohany, J.E.; Poly(vinylidene Fluoride) in : *Fluorine Chemistry: A comprehensive Treatment*; (Howe-Grant, M.; eds.), **1995**, Wiley, New-York, pp 454-472; c) Dohany, J. E., Poly(Vinylidene Fluoride). In *Kirk-Othmer Encyclopedia of Chemical Technology*, 4th ed.; Kirk, R.E.; Othmer, D.; Ed. **1998**, John Wiley and Sons; New York.
- 14 Carpenter, C.P.; Pozzani, U.C.; Smith H.F., *J. Ind. Hyg. Toxicol.*, **1949**, *31*, 343.
- 15 Bio/Dynamics, Inc., *Project # 87-8022, CMA Reference # FIG-3.3.-ONCO-BIO*, **1991**.
- 16 a) Litton Bionetics, Inc., *LBI Project # 12199-02, National Toxicology Program*, Contract # NO1-ES-28, **1984**; b) Litton Bionetics, Inc., *LBI Project # 12199-03, National Toxicology Program*, Contract # NO1-ES-2, **1984**.
- 17 TNO Nutrition and Food Research *Project # B 84-1408, Report #91.039*, **1991** Netherlands Institute for Applied Scientific Research, Delft, the Netherlands.
- 18 Calfee, J.D.; Florio, P.A.; *U.S. Patent 2,499,129* **1950** (assigned to Allied Chemical).
- 19 Schultz, N.; Martens, P.; Vahlensieck, H.J.; *Ger. Pat. 2,659,712*, **1976** (assigned to Dynamit Nobel AG).
- 20 a) Kaess, F.; Michaud; H.; U.S. Pat. 3,600,450, **1971** (assigned to Sueddeutsche Kalkstickstoff-Werke AG); b) Kaess, F.; Lienhard, K.; Michaud, H.; *Eur. Pat. 3,723,549*, **1973**

(assigned to Sued-deutsche Kalkstickstoff-Werke AG); c) Franklin, J.; Janssens, F.; Eur. Pat. Appl. 361,578, **1990** (assigned to Solvay & Cie).

21 a) Jap. Pat. 58 217,403, **1983** (assigned to Pennwalt Corp.); b) Cheminal, B.; Lantz, A.; Eur. Pat. Appl. 297,947, **1989** (assigned to Elf Atochem SA); c) Bergougnan, M.; Galland, J.M.; Perdieux, S.; Eur. Pat. Appl. 421,830 **1991** (assigned to Elf Atochem SA).

22 Feasley, C.F. ; Stover, W.H.; *U.S. Patent* 2,627,529 **1953** (assigned to Mobil).

23 Barnhart, W.S.; Mantell, R.M.; *U.S. Patent* 2,774,799 **1956** (assigned to Kellogg).

24 Meussdoerffer, J.N.; Niederpruem, H. *Ger. Pat.* 2,044,370 **1972** (assigned to Farbenfab Bayer AG (Chem. Abstr. 77, 20345 (**1972**))).

25 Hauptschein, M.; Fainberg, A.H.; *U.S. Patent* 3,188,356 **1965** (assigned to Pennsalt).

26. Fr. Pat. 1,337,360 **1963** (assigned to Produits Chimiques Pechiney Saint-Gobain).

27 a) Calfee, J.D.; Miller, C.B.; *U.S. Patent* 2,734,090 **1956** (assigned to Allied Chemical); b) Farlow, M.W.; Muetterties, E.L.; *U.S. Patent* 2,894,996 **1959** (assigned to DuPont); c) Miville, M.E.; Early, J.J.; *U.S. Patent* 3,246,041 **1966** (assigned to Pennsalt).

28 Edgel, W.F.; Ultef, C.J. ; *J. Chem. Phys.* **1954**, 22, 1983.

29 Cais, R.E., Kometani, J.M.; *Macromolecules*, **1984**, 17, 1887.

30 a) Blaise, J.; Grimaud, E.; U.S.Pat. 4,025,709 **1977** (assigned to Elf Atochem S.A.); b) Bacque, X.; Lasson, P.; Eur. Pat. Appl. 387,938 **1990** (assigned to Solvay S.A.).

31 Iseron, H.; U.S.Pat. 3,245,971 **1966** (assigned to Pennwalt Corp.).

32 Baxter, J.A.; Eddy, C.O.; Stevens, H.C.; U.S.Pat. 3,642,755 **1972** (assigned to PPG Industries, Inc).

33 a) Kureha Chem. Ind. Co. Ltd, French Patent 1,566,920 **1969** (*Chem Abstr.* 71;125237); b) Amagi, Y.; Bannai, N.; U.S. Pat. 3,553,785 **1971** (assigned to Kureha Chemical Co); c) Dohany, J.E.; U.S.Pat.3,781,265 **1973** (assigned to Pennwalt Corp.); d) Dumoulin, J.; U.S.Pat. 4,542,194 **1985** (assigned to Solvay & Cie); e) Ihara, K.; Noda, Y.; Amano, T.; Jap. Pat. 01,129,005 **1989** (assigned to Daikin Industries, Ltd.); f) Watanabe, J.; Jap. Pat. 02,029,402 **1990** (assigned to Shin-Etsu Chemical Industry Co., Ltd); g) Lasson, P.; Eur. Patent 0,417,585 **1990** (assigned to Solvay S.A.); h) Abusleme, J. A.; Gavezotti, P.; US Patent 5,569,728, **1995** (assigned to Ausimont S.p.A.); g) Brinati, G.; Arcella, V.; Albano, M.; US Patent 5,583,190 **1996** (assigned to Ausimont S.p.A.).

34 a) Carlson, D.P.; Ger. Pat. 1,806,426 **1969** ; Fr. Pat. 1 590 301 **1970** (assigned to E.I. du Pont de Nemours & Co., Inc.); b) Moggi, G.; Caratto, A.; Bonardelli, P.; Monti, C.; US Patent 4,739,024 **1988** (assigned to Montefluos S.p.A.).

35 Guiot, J.; Ameduri, B.; Boutevin, B.; *Macromolecules*, **2002**, 35, 8694.

- 36 Doll, W.W.; Lando, J.B.; *J. Appl. Polym. Sci.* **1970**, *14*, 1767.
- 37 Golub, M.A.; Wydeven, T.; *Plasmas & Polymers*, **1998**, *3*, 35.
- 38 Kammermaier, J.; Rittmayer, G.; Eur. Pat. Appl. 403,915 **1990** (assigned to Siemens AG).
- 39 Ahmed, T.S.; DeSimone, J.M.; Roberts, G.W.; *Macromolecules*, **2007**, *40*, 9322.
- 40 a) Ahmed, T.S.; DeSimone, J.M.; Roberts, G.W.; *Polym. Prepr.* **2007**, *48*, 194; b) Kennedy, K.A.; Roberts, G. W.; DeSimone, J.M.; *Adv. Polym. Sc.*, **2005**, *175*, 329.
- 41 Tai, H.; Wang, W.; Howdle, S.M.; *Macromolecules*, **2005**, *38*, 9135.
- 42 a) Beuermann, S.; Imran-ul-Haq, M; *J. Polym. Sci. Part A: Polym. Chem.*; **2007**, *45*, 5626; b) Beuermann, S.; Imran-ul-Haq, M; *Macromol. Symp.*; **2007**, *259*, 210.
- 43 Saraf, M. K.; Gerard, S.; Wojcinski, L.M.; Charpentier, P. A.; DeSimone, J. M.; Roberts, G. W.; *Macromolecules*, **2002**, *35*, 7976.
- 44 Boyer, C.; Valade, D.; Ameduri, B.; Lacroix Desmazes, P.; Boutevin, B.; *J. Polym. Sc. Part A, Polym. Chem.*, **2006**, *44*, 5763.
- 45 a) Ferguson, R.C.; *J. Amer. Chem. Soc.*; **1960**, *82*, 2416; b) Gorlitz, M.; Minke, R.; Trautvet, W.; Weisgerb, G.; *Angew. Makromol. Chem.*; **1973**, *29*, 137; c) Ferguson, R.C.; Brame Jr, E.G.; *J. Phys. Chem.*; **1979**, *83*, 1397; d) Harris, R.K.; Monti, G.A.; Holstein, P.; in Ando, I.; Asakura, T.; ed.; *Solid State NMR of Polymers; Studies in Physical and Theoretical Chemistry*, **1998**, Chapter 18; pp 667-712, Elsevier, Amsterdam; e) Macheteau, J.P.; Oulyadi, H.; van Hemelryck, B.; Bourdonneau, M.; Davoust, D.; *J. Fluorine Chem.*, **2000**; *104*, 149; f) Battiste, J.L.; Jing, N.Y.; Newmark, P.A.; *J. Fluorine Chem.* **2004**, *125*, 1331; g) Battiste, J.; Newmark, R. A.; *Prog NMR Spectr* **2006**; *48*, 1; h) Wormald, P.; Ameduri, B.; Harris, R.K.; Hazendonk, P.; *Polymer*, **2008**; *49*; 3629.
- 46 Bovey, FA; Jelinski, L.W.; *Chain Structure and Conformation of Macromolecules*, **1982**, Academic Press, New-York.
- 47 a) Matyjaszewski, K.; Davis, T. P. *Handbook of Radical Polymerization*; **2002**, Wiley-Interscience; New York; b) Matyjaszewski, K.; *Controlled/Living Radical Polymerization: from Synthesis to Materials*, ACS Symposium Series **2006**, *944*; Am. Chem. Soc.; Washington; c) Matyjaszewski, K.; Gnanou, Y.; Liebler L.; *Macromolecular Engineering*, **2007**, Vol.1 Synthetic aspects; pp 171-204; Wiley, VCH; Weiheim, Germany.
- 48 a) Oka, M.; Tatemoto, M.; "Vinylidene fluoride-hexafluoropropylene copolymer having terminal iodines" in *Contemporary Topics in Polymer Science*, (Bailey, W.J.; Tsuruta, T.; Eds) **1984**, *4*, pp.763-781, Plenum Press, New-York; b) M. Tatemoto, *Int. Poly. Sc. Tech.*; **1985**, *12*, 85-98; translated in english from *Nippon Gomu Kyokaishi*, **1985**, *57*, 761; c)

- Tatemoto, M.; Shimizu, T.; “*Thermoplastic Elastomers*” in *Modern Fluoropolymers* (Scheirs, J.; ed), **1997**, Chapt. 30, pp 565-576, Wiley, New-York.
- 49 a) Charmot, D.; Corpart, P.; Adam, H.; Zard, S.Z.; Biadatti, T.; Bouhadir, G.; *Macromol. Symp.*, **2000**, *150*, 23; b) Destarac, M.; Charmot, D.; Franck, X.; Zard, S.Z.; *Macromol. Rapid Commun.*, **2000**, *21*, 1035.
- 50 Marie, A.; PhD dissertation, University of Paris, **2002**.
- 51 a) Chung, T.C.; Hong, H.; Oka, M.; Kubo, K., USP 6,911,509 **2005** (assigned to Penn State Research Foundation/Dai-Act); b) Zhang, Z.-C.; Chung, T.C.; *Macromolecules*, **2006**, *39*, 5187.
- 52 Timmerman, R.; *J. Appl. Polym. Sci.* **1962**, *6*, 456.
- 53 Cais, R.E.; U.S. Pat. 4,438,247 **1984** (assigned to AT&T Technologies).
- 54 Ameduri, B.; Ladavière, C.; Delholme, F.; Boutevin, B.; *Macromolecules* **2004**, *37*, 7602.
- 55 Cais, R.E., Kometani, J.M.; *Org. Coating Appl. Sci. Proc.*, **1983**, *48*, 216.
- 56 Cais, R.E., Kometani, J.M.; *Macromolecules*, **1987**, *20*, 2318.
- 57 Liepins, R.; Surles, J.R.; Morosoff, N.; Stannett, V.T.; Timmons, M.L.; Wortman, J.J.; *J. Polym. Sci. Part A-1* **1978**, *16*, 3039.
- 58 British Pat. 1,004,172 **1965** (assigned to Deutsche Solvay-Werke GmbH).
- 59 Natta, G. ; Allegra, G. ; Bassi, I.W. ; Sianesi, F.; Caporiccio, G.; Torti, T.; *J. Polym. Sci. Part A*, **1965**, *3*, 4263.
- 60 Kawai, N. ; *Jap. J. Appl. Phys.* **1969**, *8*, 1975
- 61 Bergman, J.G.; McFee, J. H.; Crane, G.R.; *Appl. Phys. Lett.* **1971**, *18*, 203.
- 62 Nakamura, K.; Wada, Y.; *J. Polym. Sci. A-2*, **1971**, *9*, 161.
- 63 a) Lovinger, A.; *Developments in Crystalline Polymers* 1; Bassets, D.C.; **1982**; Applied Science Publishers, London; b) Lovinger, A.; *Science*, **1983**, *220*, 1115; c) Betz, R.; *Ferroelectrics*, **1987**, *75*, 397; d) Nalwa, H.S.; Ed *Ferroelectric Polymers*, **1995**, Marcel Dekker, New-York; e) Nalwa, H.S.; Ed *Handbook of Low and High Dielectric Constant Materials and their Applications*, **1999**; Academic Press, London; f) Muller, K.; Paloumpa, I.; Henkel, K.; Schmeisser, D.; *J. Appl. Phys.*, **2005**, *98*, 056104; g) Naber, R.C.G.; Tanase, C.; Blom, P.W.M.; Gelinck, G.H.; Marsman, A.W.; Touwslager, F.J.; Setayesh, S.; deLeeuw, D.M.; *Nature Mat.*, **2005**, *4*, 245.
- 64 Dillon, D.R.; Tenneti, K.K.; Li, C.Y.; Ko, F.K.; Sics, I.; Hsiao, B.S.; *Polymer*, **2006**, *47*, 1678 and references cited therein.
- 65 Bachman, M.A.; Lando, J.B.; *Macromolecules*, **1981**, *14*, 40.
- 66 Nasef, M. M.; Saidi, H.; Dahlan, K. Z. M.; *Polym. Degr. Stab.*, **2002**, *75*, 85.

- 67 Hasegawa, R.; Takahashi, Y.; Chatani, Y.; *Polym. J.*, **1972**, *3*, 600.
- 68 Kobayashi, M.; Tashiro, K.; Tadokoro, H.; *Macromolecules*, **1975**, *8*, 158.
- 69 Abbrent, S.; Plestil, J.; Hlavata, D.; Lindgren, J.; Tegenfeldt, J.; Wendsjo, A.; *Polymer*, **2001**, *42*, 1407.
- 70 Murata, Y.; Koizumi, N.; *Polym. J.*; **1985**, *17*, 1071.
- 71 Lovinger, A.J.; Davis, D.D.; Cais, R.E.; Kometani, J.M.; *Macromolecules*, **1986**, *19*, 1492.
- 72 Hedhli, L.; Mekhilef, N.; Moyses, S.; Lewis, R.H.; *Macromolecules* **2008**, *41*, 2011.
- 73 Hedhli, L.; Mekhilef, N.; US Pat.Appl. 0106010 **2007** (assigned to Arkema).
- 74 a) Jian, K.; Pintauro, P.N.; *J. Membrane Sci.*, **1993**, *85*, 301; b) Jian, K.; Pintauro, P.N.; Ponangi, R.; *J. Membrane Sci.*, **1996**, *117*, 117; c) Jian, K.; Pintauro, P.N.; *J. Membrane Sci.*, **1997**, *135*, 41.
- 75 Sanchez, J.Y.; Alloin, F.; Saunier, J.; “PVDF based polymers for Lithium batteries” in Nakajima T., Groult H., *Fluorinated Materials for Energy Conversion*, **2005**, Elsevier, Amsterdam, Chapt 14; 305-333.
- 76 Saunier, J.; Alloin, F.; Sanchez, J. Y.; Maniguet, L ; *J. Polym. Sci., Part B: Polym. Phys.*; **2004**, *42*, 2308.
- 77 Andrieu, X.; Jehoulet, C.; Boudin, F.; Olsen, I.I.; *Proceedings of 38th Power Source Conference*, June **1998**, p. 266.
- 78 Zhang, Z.-C.; Wang, Z.; Chung, T.C.; *Macromolecules*, **2007**, *40*, 5235.
- 79 a) Priya, L.; Jog, J.P.; *J. Polym. Sci., Part B: Polym. Phys.* **2002**, *40*, 1682; b) Priya, L.; Jog, J.P.; *J. Polym. Sci., Part B: Polym. Phys.* **2003**, *41*, 31; c) Priya, L.; Jog, J.P.; *J. Appl. Polym. Sci.*, **2003**, *89*, 2036.
- 80 Liu, H.J.; Hwang, J.J.; Chen-Yang, Y.W.; *J. Polym. Sci., Part B: Polym. Chem.* **2002**, *40*, 3873.
- 81 a) Paul, D.R.; Newman, S.; *Polymer Blend II*, **1978**, Academic Press, New-York; b) Olabisi, O.; Robeson, L.M.; Show, M.T.; *Polymer-Polymer Miscibility*, **1979**, Academic Press, New-York; c) Solc, K.; *Polymer Compatibility Incompatibility; Principles and Practice*; **1982**, MMI Press Symposium Series, Vol. 2.
- 82 a) Paul, D.R.; Barlow, J.W.; *J. Macromol. Sci. Rev. Macromol. Chem.*; **1980**, *C18*, 109; b) Lin, S.-C.; Argasinski, K.; “Fluoropolymer alloys: performance optimization of PVDF alloys”; in Hougham, G.; Cassidy, P.E.; Johns, K.; Davidson, J., eds; *Fluoropolymers : Synthesis and Applications*, **1999**, Vol. 2, Plenum Publish., New-York.
- 83 Soria, V.; Gomez, C. M.; Rodriguez, P.; Parets, M. J.; Campos, A.; *Colloid Polym. Sci.*, **1994**, *272*, 497.

- 84 a) Mijovic, J.; Luo, H.-L.; Han, C.D.; *Polym. Eng. Sci.* **1982**, 22, 234; b) Yoshida, H.; *J. Therm. Anal.*; **1997**, 49, 101.
- 85 a) Roerdink, E.; Challa, G.; *Polymer* **1978**, 19, 173; b) Eijkelenboom, A.P.A.M. ; Maas, W. E. J. R.; Veeman, W. S.; Buning, G. H. W.; Vankan, J. M. J.; *Macromolecules*, **1992**, 25, 4511.
- 86 a) Leonard, C.; Halary, J.L.; Monnerie, L.; *Polymer*, **1985**, 26, 1507; b) Schneider, S.; Drujon, X.; Wittmann, J. C.; Lotz, B.; *Polymer*; **2001**, 42, 8799; c) Pimbert, S.; Avignon-Poquillon, L.; Levesque, G.; *Polymer*, **2002**, 43, 3295.
- 87 Ma, W.; Zhang, J.; Chen, S.; Wang, X.; *Appl. Surf. Sci.*, **2008**, 254, 5635.
- 88 Ma, H.; Yang, Y.; *Polym. Test.*; **2008**, 27, 441.
- 89 Li, Y.; Iwakura, Y.; Shimizu, H.; *J. Nanosci. Nanotechn.*; **2008**, 8, 1714.
- 90 a) Vo, L.T.; Giannelis, E. P.; *Macromolecules*, **2007**, 40, 8271; b) Giannelis, E. P.; proceedings of the Fluoropolymer Conference, Charleston, S.C., 2008, Oct. 19-22..
- 91 Olkhov, Yu. A.; Allayarov, S.R.; Konovalova, T.A.; Kispert, L.D.; Nikles, L.E.; *J. Appl. Polym. Sci.*, **2008**; 108, 2085.
- 92 a) Navarra, M.A.; Panero, S.; Scrosati, B.; *J. Solid State Electrochem.*, **2004**, 8, 804; b) Martinelli, A.; Navarra, M.A.; Matic, A.; Panero, S.; Jacobsson, P.; Scrosati, B.; *Electrochim. Acta*, **2005**, 50, 3992.
- 93 a) Mokrini, A.; Huneault, M.A.; *J. Power Sources*, **2006**, 154, 51; b) Mokrini, A.; Huneault, M.A.; Gerald, P.J.; *J. Membr. Sci.*, **2006**, 283, 74.
- 94 Piboonsatsanasakul, P.; Wootthikanokkhan, J.; Thanawan, S.; *J. Appl. Polym. Sci.* **2008**, 107, 1325.
- 95 a) Buchi, F.N.; Gupta, B.; Haas, O.; Scherer, G.G.; *Electrochim. Acta*, **1995**, 40, 345; b) Becker, W.; Schmidt Haake, G.; *Chem. Eng. Technol.* **2002**, 25, 4.
- 96 Nasef, M.; Zubir, N. A.; Ismail, A. F.; Khayet, M. ; *Desalination*, **2006**, 200, 35.
- 97 Moszczynski, P.; Kalita, M.; Parzuchowski, P.; Siekierski, M.; Wieczorek, W.; *J. Power Sources*, **2007**, 173, 648.
- 98 Prakash, G.K.S.; Smart, M. C.; Wang, Q.-J.; Atti, A.; Pleyne, V.; Yang, B.; McGrath, K.; Olah, G. A.; Narayanan, S. R.; Chun, W.; Valdez, T.; Surampudi, S.; *J. Fluorine Chem.* **2004**, 125, 1217.
- 99 Prakash, G. K. S.; Olah, G. A.; Smart, M. C.; Narayanan, S. R.; Wang, Q.S.; Surampudi, S.; Halpert, G. PCT Int. Appl. WO 9822989 **1998** (assigned to University of Southern California).
- 100 McGrath, K.M.; Prakash, G. K. S.; Olah, G. A.; *J. Ind. Eng. Chem.* **2004**, 10, 1063.

- 101 Goldbach, J.T.; More, K.L.; Gaboury, S.R.; Foure, M.; Mountz, D.A.; Manheim, A.L. assigned to Arkema Inc., AIChE Spring National Meeting, Conference Proceedings, Orlando, FL, United States, Apr. 23-27, **2006**, P42709/1.
- 102 Goldbach, J. T.; Gaboury, S.; Umpleby, R. J.; Parvole, J.; Mountz, D.A.; PCT Int. Appl. US 0269815 **2006** (assigned to Arkema Inc.).
- 103 a) Wootthikanokkhan, J.; Seeponkai, N.J.; *J. Appl. Polym. Sci.* **2006**, *102*, 5941; b) Ren, S.; Sun, G.; Li., C.; Wu, Z.; Jin, W.; Chen, W.; Xin, Q.; Yang, X.; *Mater. Lett.*, **2006**, *60*, 44; c) Jung, H.J.; Park, J.K.; *Electrochim. Acta*, **2007**, *52*, 7464.
- 104 Arunbabu, D. ; Sannigrahi, A.; Jana, T; *J. Phys. Chem. B* **2008**, *112*, 5305.
- 105 Jeong, M. A.; Yu, D. H.; Koh, M.J.; Rhim, J. W.; Byun, H. S.; Seo, M. S.; Nam, S. Y. *Membrane J.* ; **2008**, *18*, 84.
- 106 Yang, Y.; Zhang, J.; Zhou, C.; Wu, S.; Xu, S.; Liu, W.; Han, H.; Chen, B.; Zhao, X.-Z.; *J. Phys. Chem. B*; **2008**, *112*, 6594.
- 107 a) Herbert, J.M.; Glass, A.M.; Wang, T.T.; *The Applications of Ferroelectric Polymers*, **1988**, Chapman & Hall, New-York; b) Zhang, Q.M.; Bharti, V.; Zhao, X.; *Science*, **1998**, *280*, 2101; c) Pelrine, R.; Kornbluh, R.; Pei, Q.; Joseph, J.; *Science*, **2000**, *287*, 836; d) Bar-Cohen, Y. ; *Electroactive Polymer (EAP) Actuators as Artificial Muscles - Reality, Potential and Challenges*; **2001**; SPIE, Bellingham, Wa, USA; e) Zhang, Q.M.; Li, H.F.; Poh, M.; Xu H.S.; Cheng Z.-Y.; Xia, F.; Huang, C.; *Nature*, **2002**, *419*, 248.
- 108 Lu, J.; Kim, S.-G.; Lee, S.; Oh, I.-K.; Proceedings of SPIE; **2008**, 6927 (Electroactive Polymer Actuators and Devices (EAPAD)); b) Lu, J.; Kim, S.-G.; Lee, S.; Oh, I.-K.; *Adv. Function. Mat.* **2008**, *18*, 1290.
- 109 a) Ebnesajjad, S.; Ed.; *Fluoroplastics*, **2003**, Plastic Design Library Series, Norwich, New-York ; b) Ebnesajjad, S.; Ed.; *Fluoroplastics , Volume 2: Melt Processible Fluoropolymers ; The Definitive User's Guide and Databook* **2003**, William Andrew Publishing, Norwich, New-York.
- 110 Zimbo, M.; Theodore, A.N.; *Ind. Eng. Chem. Res.*, **1994**, *33*, 1017.
- 111 Maccone, P.; Apostolo, M.; Ajroldi, G. ; *Macromolecules* **2000**, *33*, 1656.
- 112 Welch, G.J.; *Polymer*, **1974**, *15*, 429.
- 113 Ali, S.; Raina, A.K.; *Makromol. Chem.*, **1978**, *179*, 2925.
- 114 Lutinger, G.; Weill, G.; *Polymer*, **1991**, *32*, 877.
- 115 Hull, E.; Johnson, B.V.; Rodricks, I.P.; Staley, J.B.; “ *THV Fluoroplastic* ” in “ *Modern Fluoropolymers* ” (Scheirs, J.; ed), **1997**, Chapter 13, pp.257-270 Wiley, New-York.
- 116 Conroy, M.E.; *Rubber Age*, **1955**, *76*, 543.

- 117 Mandelkern, L.; Martin, G.M.; Quinn, F.A.; *J. Research Nat. Bureau Stand.*; **1957**, 58, 137.
- 118 Kalfoglo, J.; Williams, H.L.; *J. Appl. Polym. Sci.* **1973**, 17, 3367.
- 119 Wang, Z.M.; Zhang, Z.C.; Chung, T.C.; *Macromolecules*; **2006**, 39, 4268.
- 120 Latour, M.; Dorra, H.A.; *Ferroelect. Lett*; **1982**, 44, 197.
- 121 Solef[®] <http://www.solvaysolexis.com/products/bybrand/brand/0.,15939-2-0.00.htm>, consulted on Sept 4th, 2008 b) KynarFlex[®] <http://www.arkema-inc.com/index.cfm?pag=102> consulted on Sept 4th, 2008; c) Dyneon[®] Fluoroelastomers copolymers http://solutions.3m.com/wps/portal/3M/en_US/dyneon_fluoropolymers/Home/Products_and_Solutions/Products/Fluoroelastomers-FKMs/Fluoroelastomers/Fluoroelastomer_Copolymers.
- 122 Blaise, J.; Kappler, P.; Eur. Pat. 0,280,591 **1988** (assigned to Atochem).
- 123 Andrus, Jr M.H.; Olsen, R.J.; Eian, G.L.; Allen, R.C.; *Chlorotrifluoroethylene suspension polymerization*; in Hougham, G.; Cassidy, P.; Johns, K.; Davidson, T.; eds; *Fluoropolymers*; **1999**, 1, pp 81-90; Kluver Academic, New-York.
- 124 a) Murasheva, Y. M.; Shashkov, A. S.; Galil-Ogly, F. A.; *Vysokomol. Soedin., Ser. A* **1979**, 21, 882; b) Murasheva, E. M.; Shashkov, A. S.; Galil-Ogly, F. A.; *Polym. Sci. U.S.S.R.*, **1979**, 21, 968.
- 125 a) Chung, T.C.; Petchsuk, A.; *Macromolecules*, **2002**, 35, 7678; b) Chung, T.C.; Petchsuk, A.; US Patent 6,355,749 **2002** (assigned to Dai-Act).
- 126 a) Lu, Y.; Claude, J.; Neese, B.; Zhang, Q.M.; Wang, Q.; *J. Amer. Chem. Soc.*, **2006**, 128, 8120; b) Lu, Y.; Claude, J.; Neese, B.; Zhang, Q.M.; Wang, Q.; *Macromolecules*, **2006**, 39, 6962.
- 127 Chu, B.; Zhan, X.; Ren, K.; Neese, B.; Lin, M.; Wang, Q.; Bauer, F.; Zhang, Q.M.; *Science* **2006**, 313, 334.
- 128 Zhang, Z.C.; Chung, T.C.; *Macromolecules* **2007**, 40, 783.
- 129 Li, Z.; Wang, Y.; Cheng, Z.-Y.; *Appl. Phys. Lett.* **2006**, 88, 062904-1.
- 130 Shan, X.; Li, S.; Yang, X.; Cheng, Z.; *Mater. Res. Soc. Symp. Proc.*: **2007**; 949; *Proceedings of the Materials Research Society 0949-C03-19*.
- 131 a) Cais, R. E.; Kometani, J. M.; *Macromolecules*, **1984**, 17, 1932; b) Cais, R. E.; Kometani, J. M.; *Macromolecules*, **1985**, 18, 1354.
- 132 Lovinger, A.J.; Davis, D.D.; Cais, R.E.; Kometani, J.M.; *Polymer* **1987**, 28, 617.
- 133 Feiring, A.E.; Hulburt, J. D.; *Chem. Eng. News*; **1997**, 75, 6.

134 a) Honn, F.; Hoyt, J.M.; US Pat. 3,053,818 **1962** (assigned to Minnesota Mining and Manufacturing Co.); b) Sakagami, T.; Arakawa, N.; Teramoto, Y.; Nakamura, K.; US Pat 4,554,335 **1985** (assigned to Kureha Chemical Industry, Co.).

135 Inukai, H., Kawai, N.; Kitahara, T.; Kai, S. Kubo, M.; US Pat 5,087, 679 **1992** (assigned to Daikin).

136 Claude, J.; Lu, Y.; Li, K.; Wang, Q.; *Chem. Mat.* **2008**, *20*, 2078.

137 Xu, H. ; Cheng, Z. ; Olson, D.; Mai, T.; Zhang, Q.M.; Kavarnos, G.; *Appl. Phys. Lett.* **2001**, *78*, 2360.

138 Chung, M.; Zhang, Z.; Chalkova, E.; Wang, C.; Fedkin, M.; Komarneni, S.; Sharma, S.; Lvov, S.; *Electr. Chem. Soc. Trans.*, **2007**, *11*, 35; proceedings of the 212th Meeting of the Electr. Chem. Soc., Washington (USA), Oct. 7-12, **2007**.

139 a) Zhang, Q.M.; Chu, B.; Zhou, X.; Lu, Y.; Wang, Q.; Neese, B.; PCT WO 078916 **2007** (assigned to Penn State University); b) Claude, J.; Lu, Y.; Wang, Q.; *Appl. Phys. Lett.*; **2007**, *91*, 212904.

140 Chen, Q.; Lin, M.; Lee, J.E.; Zhang, Q.; Yin, S.; *Mater. Res. Soc. Symp. Proc.*; **2007**; *949*; *Materials Research Society*; 0949-C02-04.

141 Yagi, T.; Tsuda, N.; Noguchi, T.; Sakaguchi, K.; Tanaka, Y.; Tatemoto, M.; Eur. Pat. Appl. 0,422,644 **1990** (assigned to Daikin).

142 Kawashima, C.; Yasamura, T.; *Japanese Patent* JP 59 30,847 **1984** (Chem. Abstr. 101 : 73689); US patent 4,472,557 **1984**; British patents 2,161,816 **1987** and 2,180,544 **1987** (assigned to Central Glass).

143 Yagi, T.; Tatemoto, M.; *Polym. J.*, **1979**; *11*, 429.

144 Aimi, K.; Ando, S., Avalle, P.; Harris, R.K.; *Polymer*, **2004**, *45*, 2281.

145 a) Furukawa, T.; Date, M.; Fukada, E.; Tajitsu, Y.; *Jpn. J. Appl. Phys.*; **1980**, *19*, 109; b) Higashihata, Y.; Sako, J.L.; Yagi, T.; *Ferroelectrics*, **1981**, *32*, 85; c) Lovinger, A.J.; Davis, G.T.; Furukawa, T.; Broadhurst, M.G.; *Macromolecules* **1982**, *15*, 323; d) Nalwa, H.S.; *J. Macromol. Sci. Rev. Macromol. Chem. Phys.* **1991**, *C31*, 341 ; e) Teysedre, G.; Lacabanne, C.; *Polymer*, **1995**, *36*, 3641.

146 a) Yagi, T.; Tatemoto, M.; Sako, J.; *Polymer J.*; **1980**, *12*, 209 ; b) Furukawa, T.; Johnson, G.E.; Bair, H.E.; Tajitsu, Y.; Chiba, A.; Furukawa, E.; *Ferroelectrics*; **1981**, *32*, 61; c) Tashiro, K. ; Tadokoro, H. ; Kobayashi, M.; *Ferroelectrics*, **1981**, *32*, 167 ; d) Tashiro, K., in *Ferroelectric Polymers*, Nalwa H.S.; ed.; **1995**, p. 63, Marcel Dekker, New-York.

147 Xu, T.B.; Cheng, Z.Y.; Zhang Q.M.; Baugham R.H.; Cui, C.; Zakhidov A.A.; Su J.; *J. Appl. Phys.*; **2000**, *88*, 405.

- 148 Ohigashi H., Omote K., Gomyo T., *Appl. Phys. Lett.*, **1995**, *66*, 3281.
- 149 Fang, F.; Yang, W.; Jia, C.; Luo, X. ; *Appl. Phys. Lett.*; **2008**, *92*, 222906.
- 150 a) Noda, K. ; Ishida, K.; Kubono, A.; Horiuchi, T.; Yamada, H.; Matsushige, K.; *J. Jap. Appl. Phys.*; **2001**, *40*, 4361; b) Takashima, K.; Horie, S.; Mukai, T.; Ishida, K.; Matsushige, K.; *Sensors Act., A: Physical*, **2008**, *A144*, 90.
- 151 Yu, Z.; Ang, C.; Cross, L.E.; Petschuk, A.; Chung, T.C.; *Appl. Phys. Lett.*, **2004**, *84*, 1737.
- 152 Wang, C.C.; Song, J.F.; Bao, H.F.; Shen, Q.D.; Yang, C.Z.; *Adv. Funct. Mater.* **2008**, *18*, 1299.
- 153 Poulsen, M.; Sorokin, A.V.; Adenwalla, S.; Ducharme, S.; Fridkin V.M.; *J. Appl. Phys.*, **2008**, *103*, 034116.
- 154 Dixon, S; Rexford, D.R.; Rugg, J.S.; *Ind. Eng. Chem.***1957**, *49*, 1687.
- 155 Lo, E.S.; *US Pat.* 3,178,399 (**1965**) assigned to 3M.
- 156 Ahmed, T. S.; DeSimone, J.M.; Roberts, G.W.; *Macromolecules*, **2006**, *39*, 15.
- 157 Ajroldi, G.; Pianca, M.; Fumagalli, M.; Moggi, G.; *Polymer* **1989**, *30*, 2180.
- 158 Apostolo, M.; Arcella, V.; Sorti, M.; Morbidelli, M.; *Macromolecules*, **1999**, *32*, 989.
- 159 Pianca, M.; Bonardelli, P.; Tato, M.; Cirillo, G.; Moggi, G.; *Polymer*, **1987**, *28*, 224.
- 160 Moggi, G.; Bonardelli, P.; Bart C.J.; *Polym. Bull.* **1982**, *7*, 115.
- 161 Tarascon, J.M.; Gozdz, A.S.; Schmutz, C.N.; Shukoki, F.; Warren, P.C.; *Solid State Ionics*, **1996**, *86-88*, 49.
- 162 a) Asandei, A.D.; Chen, Y.; Abstracts of Papers, **2008**; 235th ACS National Meeting, New Orleans, LA, United States, April 6-10, **2008**, *Polym. Mat. Sci. Eng.*-223; b) Asandei, A.D.; Chen, Y.; Abstracts of Papers, **2005** ; 230th ACS National Meeting, Washington, DC, United States, Aug. 28-Sept. 1, **2005**, POLY-569 (*Polym. Prepr. Amer. Chem. Soc. Polym. Div.*); c) Asandei, A.D.; Chen, Y.; Abstracts of Papers, **2007**; 234th ACS National Meeting, Boston, MA, United States, August 19-23, **2007**, POLY-127 (*Polym. Prepr. Amer. Chem. Soc. Polym. Div.*).
- 163 Wolak, M.A.; Pan, M.-J.; Wan, A.; Shirk, J. S.; Mackey, M.; Hiltner, A.; Baer, E.; Flandin, L.; *Appl. Phys. Lett.*, **2008**, *92*, 113301/1.
- 164 Wang, Z.; Tang, Z.; *Mater. Chem. Phys.*; **2003**, *82*, 16.
- 165 a) Brewis, D.M.; Mathieson, I.; Sutherland, I.; Cayless, R.A.; Dahn, R.H.; *Intern. J. Adhes.* **1996**, *16*, 87; b) Hinskman, P.; Isaac, D.H.; Morrissey, P.; *Polym. Degrad. Stab.*, **2000**; *68*, 299; c) Ross, G.J.; Watts, J.F.; Hill, M.P.; Morrissey, P.; *Polymer*, **2000**, *41*, 1685; d) Mitra, S.; Ghanbari-Siahkali, A.; Kingshott, P.; Hvilsted, S.; Almdal, K.; *J. Polym. Sci.*,

Part A: Polym. Chem., **2004**, *42*, 6216; e) Mitra, S.; Ghanbari-Siahkali, A.; Kingshott, P.; Almdal, K.; Helle, K. R., Christensen, A.G.; *Polym. Degr. Stab.*; **2004**, *83*, 195.

166 Song, M.-K.; Kim, Y.-T.; Fenton J. M.; *J. Power Source*; **2003**, *117*, 14.

167 Cho, K.Y.; Jung, H.Y.; Sung, K.A.; Kim, W. K.; Sung, S.J.; Park, J.K.; Choi, J.H.; Sung, Y. E.; *J. Power Sources*, **2006**, *159*, 524.

168 a) Niepceron, F. ; Galiano, G.; Tassin, J.F.; French Patent FR 55957, **2007** (assigned to CEA); b) Niepceron, F; Ph D dissertation, Universite du Maine (Le Mans), France, **2008**.

169 Fernicoal, A.; Panero, S.; Scrosati, B.; Tamada, M.; Ohno,H.; *Chem. Phys. Chem.*, **2007**, *8*, 1103.

170 a) Watanabe, M.; Kanaba, M.; Matsuda, H.; Mizo'gusbi, K.; Shinoshara, I.; Tsuchida, E.; Tsunemi, K.; *Makromol. Chem. Rapid Comm.* **1981**, *2*, 741; b) Michot, T.; Nishimoto, A.; Watanabe, M.; *Electrochim. Acta*, **2000**, *45*, 1347.

171 Gozdz, A.S.; Schmutz, C.N.; Tarascon, J.M.; US Patent 5,296,318 **1994** (assigned to Bellcore).

172 Song, J.Y.; Wang, Y.Y.; Wan, C.C.; *J. Power Sources*, **1999**, *77*, 183.

173 Feuillade, G.; Perche, P.; *J. Appl. Electrochem.*, **1975**, *5*, 63.

174 Wang, Y.; Travas-Sejdic, J.; Steiner, R.; *Solid State Ionics*, **2002**, *148*, 443.

175 Song, J.Y.; Wang, Y.Y.; Wan, C.C.; *Electrochem. Soc.*, **2000**, *147*, 3219.

176 a) Caillon-Caravanier, M.; Claude-Montigny, B.; Lemordant, D.; Bosser, G.; *J. Power Sources*; **2002**, *107*, 125 ; b) Lemordant, D.; Blanchard, F.; Bosser, G.; Caillon-Caravanier, M.; Carre, B.; Chagnes, A.; Montigny, B.; Naejus, R.; (in Nakajima, T.; Groult, H.; Ed), *Fluorinated Materials for Energy Conversion* ; **2005**, Chapt. 7, Elsevier, Amsterdam; pp 137-171.

177 Ye, H.; Huang, J.; Xu, J. J.; Khalfan, A.; Greenbaum, S.G; *J. Electrochem. Soc.*, **2007**; *154*, A1048.

178 Park, M.-S.; Hyun, S.-H.; Nam, S.C.; Cho, S. B; *Electrochim. Acta*, **2008**, *53*, 5523.

179 Coulon, M.; Silvert, P.-Y.; Irissin-Mangata, J.; Ameduri, B. ; PCT WO 082571 **2002** (assigned to Carbone Lorraine).

180 Cheng, C.L.; Wan, C.C.; Wang, Y.Y.; *Electrochem. Comm.*, **2004**, *6*, 53.

181 Kim, Y.-T.; Song, M.K.; Cho, B. W.; Rhee, H.-W; *Mol. Cryst. Liq. Cryst. Sci. Tech., A: Mol. Cryst. Liq. Cryst.*, **2002**, *377*, 349.

182 Wang, M.; Zhao, F.; Dong, S.; *J. Phys. Chem. B* **2004**, *108*, 1365.

- 183 a) Wang, P.; Zakeerudin, S.M.; Grätzel, M.; *J. Fluorine Chem.* **2004**, *125*, 1241; b) Zhang, J. H.; Han H.; Xu, S.; Wu, S.; Zhou, C.; Yang, Y.; Zhao, X.; *J. Appl. Polym. Sci.*, **2008**, *109*, 1369.
- 184 a) Pellerite, M.; 230th ACS National Meeting, Washington, D.C., United States, August 28-September 1, 2005, *Polym. Prepr.*, **2005**, *46*, 741; *Amer. Chem. Soc. Polym. Div.*; b) Dams, R.; “Fluorine & Silicones in Coatings” Conference, **2005**, Manchester, December, 6-7, 2005; c) Dyneon™ Fluoroelastomer Terpolymers
http://solutions.3m.com/wps/portal/3M/en_US/dyneon_fluoropolymers/Home/Products_and_Solutions/Products/Fluoroelastomers-FKMs/Fluoroelastomers/ consulted on September 12th, 2008.
- 185 Boulahia, D.; Manseri, A.; Ameduri, B.; Boutevin, B.; Caporiccio, G.; *J. Fluorine Chem.* **1999**, *94*, 175.
- 186 Dec, S.F.; Wing, R.A.; Maciel, G.E.; *Macromolecules*, **1987**, *20*, 2754.
- 187 Pacetti, S.; PCT Int. Appl. WO 064058 A2 **2008** (assigned to Abbott Laboratories).
- 188 Emmons, E. D.; Velisavljevic, N.; Schoonover, J. R.; Dattelbaum, D. M., *Appl. Spectr.*, **2008**, *62*, 142.
- 189 a) Auhl, D.; Kaschta, J.; Münstedt, H.; Kaspar, H.; *Macromolecules*, **2006**, *39*, 2316; b) Stange, J.; Wächter, S.; Münstedt, H.; Kaspar, H.; *Macromolecules*, **2007**, *40*, 2409.
- 190 Lannuzel, T.; Meunier, V.; Faig, R.; Vidberg, O. ; PCT Int. Appl. 010233 **2002** (assigned to Solvay).
- 191 Souzy, R.; Ameduri, B.; Boutevin, B.; *Macromol. Chem. Phys.*, **2004**, *205*, 476.
- 192 a) Howard, E.G.; US Pat 3,334,777 **1967** (assigned to DuPont); b) Miyata, S.; Kobayashi, S.; *US patent* 4,591,616 **1986** (assigned to Central Glass).
- 193 England, D.C.; Howard, E.G.; US Pat 4,299,949 **1981** (assigned to DuPont)
- 194 Souzy, R.; Ameduri, B.; Boutevin, B.; *J. Polym. Sci. Part A, Polym. Chem.*, **2004**; *42*, 5077.
- 195 Souzy, R.; Ameduri, B.; Boutevin, B.; Capron, P.; Marsacq, D.; Gebel, G.; *Fuel Cell*, **2004**, *5*, 383.
- 196 Kostov, G.; Ameduri, B.; Sergeeva, T.; Dolbier Jr, W. R.; Winter, R.; Gard, G. *Macromolecules*, **2005**; *38*, 8316.
- 197 Boyer C., Ameduri B., Boutevin B., Dolbier Jr, W.R., Winter R., Gard G., *Macromolecules*, **2008**, *41*, 1254.

- 198 a) Cais, R.E. ; Kometani, J.M. ; *Anal. Chim. Acta*; **1968**, 189, 101; b) Madorskaya, L. Ya.; Budtov, V. P.; Otradina, G. A.; Makeenko, T. G.; Kharcheva, E. Yu.; Loginova, N. N.; *Vysokomol. Soedin., Ser. A*, **1986**, 28, 952 (Chem. Abstr. 106:156898).
- 199 Loginova, N. N.; Podlesskaya, N. K.; Berezina, G. G. USSR. *Plast. Massy*, **1990**, 19 (Chem. Abstr.114:102888).
- 200 a) Yuan, C.-G.; Hu, C.-P.; Xu, X.; Zhang, Q.-L.; Hu, Q.H.; *Huadong Ligong Daxue Xuebao*, **2001**, 27, 265 (Chem. Abstr. 135:331716); b) Yuan, C.; Hu, C.; Xu, X.; Zhang, Q.; Hu, Q.; *Gaofenzi Xuebao*, **2001**, 316 (Chem. Abstr. 135:167079).
- 201 Naberezhnykh, R. A.; Sorokin, A.D.; Volkova, E.V.; Fokin, A.V.; *Izv. Akad. Nauk SSSR, Ser. Khim.*, **1974**, 1, 232.
- 202 Golub, M. A.; Wydeven, T., *Polym. Prepr.; Polym. Div.; Amer. Chem. Soc.* **1997**,38, 1035.
- 203 Zhou, R.; Wu, W.; Lu, M.; Zu, Z.; *Gaofenzi Xuebao*, **1987**, 56 (Chem. Abstr.107:78324); b) Kochervinskii, V.V.; Murasheva, Y.M.; *Vysokomol. Soed.*, **1991**, A33, 2096.
- 204 Loginova, N. N.; Madorskaya, L. Y.; Agapitov, A. P.; Samoilov, V. M.; Navrotskii, V. A.; Podlesskaya, N. K.; Ivanchev, S. S; *Vysokomol. Soedin., Ser. A*; 1990, 32, 2367 (Chem. Abstr. 115:29997).
- 205 Lovinger, A. J.; *Macromolecules*, **1983**, 16, 1529.
- 206 Lando, J.B.; Doll, W.W.; *J. Macromol. Sci. Phys.*, **1968**, B2, 205.
- 207 a) Baise, A.I. ; Lee, H. ; Oh, B. ; Salomon, R.E.; Labes, M.M. ; *Appl. Phys. Lett.* **1975**, 26, 428; b) Latour, M.; *Polymer*, **1977**, 18, 278; c) Stefanou, H.J.; *J. Appl. Phys.*, **1979**, 50, 1486.
- 208 Lovinger, A.J.; Davis, D.D., Cais, R.E. ; Kometani, J.M. ; *Macromolecules*, **1988**, 21, 78.
- 209 Hung, M.-H.; Tang, P. L., U.S. Pat. Appl.100101, **2007** (assigned to DuPont performance Elastomers).
- 210 Sakagami, T.; Arakawa, N.; Murayama, N.; Ger. Pat. DE 3,429,767 A1, **1985** (assigned to Kureha Chemical Industry Co., Ltd.). (Chem. Abstr. 102:221650).
- 211 Sakagami, T.; Arakawa, N.; Kakutani, H.; Eur. Pat. Appl EP 130,700 A1 **1985** (assigned to Kureha Chemical Industry Co., Ltd.).
- 212 Yasumichi, I.; Wachi, H.; *US Patent* 4,758,618 **1988** (assigned to Asahi Glass).
- 213 Chen, Z.; Christensen, L.; Dahn, J.R.; *Electrochem. Comm.*; **2003**, 5, 919.
- 214 Bolstad, A. N.; *US Pat.* 3,163,628 **1964** (assigned to 3M Co).
- 215 Sianesi, D.; Bernardi G.C.; Regio, A.; *US patent* 3,331,823 **1967** (assigned to Montedison).

- 216 Usmanov, K. U.; Yul'Chibaev, A.A.; Mukhamadaliyev, N.; Sarros, T.K.; *Izv. Vys. Zhim. Khim. Tekhnol.* ; **1975** ; 18, 464 (Chem. Abstr. 83, 28687)
- 217 Ameduri, B.; Brandstadter, S.M.; Kostov, G.K.; US Appl.11/888,694 **2006** and PCT/US 017350 **2007** (assigned to Great Lakes Chem. Co.).
- 218 Bowers, S.; Schmiegel, W.W.; *Internation. Pat.* WO 11,050 **2000** (assigned to DuPont).
- 219 Ameduri, B.; Brandstadter, S.M.; Kostov, G. K.; PCT WO 019,068 **2008** (assigned to Great Lakes Chem. Co.).
- 220 Otazaghine, B.; Sauguet, L.; Ameduri, B.; *J. Fluorine Chem.*, **2005**, 126, 1009.
- 221 Balague, J.; Ameduri, B.; Boutevin, B.; Caporiccio, G.; *J. Fluorine Chem.*, **2000**,102, 253.
- 222 a) Watanabe, J.; Fujiwara, M.; Eur. Pat. 0,302,784 **1990** (assigned to Shin Etsu); b) Watanabe, J.; Fujiwara, M.; Eur. Pat. 0,388,202 **1990** (assigned to Shin Etsu).
- 223 a) Kostov, G. K.; Ameduri, B.; Brandstadter, S.M.; PCT/US 017422 **2007** (assigned to Great Lakes-Chemtura); b) Kostov, G. K.; Ameduri, B.; Boschet, F.; Brandstadter, S. (in preparation).
- 224 Samuels, G.J.; Shafer, G.J.; Li, T.; Threlfall, C. A.; Iwamoto, N.; Rainal, E.J.; PCT Int. Appl. WO 079,986 A1 **2008** (assigned to Honeywell International Inc., USA).
- 225 a) Apotheker, D.; Finlay, J. B.; Krusic, P. J.; Logothetis, A. L.; *Rubber Chem. Techn.*, **1982**, 55, 1004; b) Apotheker, D.; Krusic, P.J.; US Patent 4,214,060 **1988** (assigned to Dupont).
- 226 a) Kaneko, T.; Sugitani, K.; Saito, M.; Hirai, H.; Jap. Pat. 0632 9861 **1994** (assigned to Asahi Glass); b) Kawasaki, K.; Enokida, T.; Tatsu, H.; Jap. Pat 09,255,732 **1997** (assigned to Nippon Mektron) ; c) Anolick, C.; Petrov, V.A.; Smart, B.E.; Stewart, C.W.; Whealand, R.C.; Farnham, W.; Feiring, A.; Qui, W.; WO 9,641,823 **1998** (assigned to Dupont); d) Duvalsaint, F.; Moore, A.L.; US Pat. 6,277,937 **1998** (assigned to Dupont Dow Elastomers); e) Kaspar, H.; Hintzer, K.; Van Gool, G.; Maiz, F.; WO 024,786 **2004** (assigned to 3M Innovative Properties Co.); f) Kaspar, H.; Hintzer, K.; US Pat 052,557 **2006** (assigned to 3M Innovative Properties Co.); g) Hintzer, K.; Jurgens, M.; Kaspar, H.; Lochhass, K.H.; Schwertferger, W.; US Pat 135,717 **2006** (assigned to 3M Innovative Properties Co.).
- 227 Sauguet, L.; Ameduri, B.; Boutevin, B.; *Macromol. Chem. Phys.* **2007**, 208, 1061.
- 228 a) West, A.C.; WO 00,573 **1981** (assigned to 3M); b) Krueger, R.; Woeste, G.; Filchakova, T.; Kollar, A.N.; Sokolov, S. V.; Greenblat, M. P.; Veretennikov, N. V.; Eur Pat 774,472 **1997** (assigned to Bayer A.-G); c) Akimoto, H.; Saito, S.; Tatsu, H.; Jap. Pat. 07,732 **2000** (assigned to Nippon Mektron Co Ltd); d) Shimizu, T.; Enokida, T.; Naraki, A.; Tatsu,

H.; Jap. Pat. 230,096 **2000** (assigned to Nippon Mektron Co Ltd) ; e) Enokida, T.; Yamada, O.; US Pat. 6,281,312 **2001** (assigned to Nippon Mektron Co Ltd); f) Saito, S.; Kanega, A.; Horie, S.; Kudo, S.; US 181,022 **2004** (assigned to Unimatec Co, Ltd); g) Kaspar, H.; Hintzer, K.; Eur Pat 1,634,895 **2006** (assigned to 3M); h) Kostov, G.; Sauguet, L.; Ameduri, B.; Kaspar, H.; Zipples, T.; Hinzer, K.; submitted to *Macromolecules*.

229 a) Moggi, G.; Bonardelli, P.; Bart, J.C.; *J. Polym. Sci, Part A, Polym. Chem.* **1984**, 22, 2441; b) Udagawa, R.; Eur Pat 081,391 **2001**; c) Stacionne, A.; Albano, M.; Eur. Pat. 1,347,012 **2003** (assigned to Ausimont).

230 a) Brodoway, N.; US patent 3,987,126 **1999** (assigned to DuPont); b) Ameduri, B.; Armand, M.; Manseri, A.; Boucher, M.; WO 096,268 **2001** and US demand 0,181,615 **2003** (assigned to Hydro-Quebec); c) Guiot, J.; Neouze, M.A.; Sauguet, L.; Ameduri, B.; Boutevin, B.; *J. Polym. Sci, Part A, Polym. Chem.* **2005**, 43, 917.

231 a) Kojima, G.; Kodama, S.; Yamabe, M.; Kaneko, I.; Eur. Pat. Appl. 0,079,555 **1988** (assigned to Asahi Glass); b) Arcella, V.; Ferro, R.; Albano, M.; Minutillo, A.; *Kautschuck Gummi Kunst.*, **1991**, 44, 833; c) Wlassics, I.; Tortelli, V.; Navarrini, W.; Albano, M.; Eur. Pat. Appl. EP 0,769,521 **1992** (assigned to Ausimont); d) Arcella, V.; Albano, M.; Barchiesi, E.; Brinati, G.; Chiodini, G.; *Rubber World* **1993**, 207, 18; e) Funaki, A.; Kato, K.; Takakura, T.; Miyake, H.; Jap. Pat. 06306196 **1996** (assigned to Asahi Glass, Co.); f) Wlassics, I.; Giannetti, E.; Canadian patent CA 2,182,328 **1997** (assigned to Ausimont); g) Tamura, M.; Miyake, H.; Jap Pat 1,0158,376 **1998**.

232 Ameduri, B.; Kostov, K.; Boutevin, B.; *Macromol. Chem. Phys.*, **2002**, 203, 1763.

233 a) Doyle, M.; Rajendram, G., In *Handbook of Fuel Cells- Fundamentals, Technology, and Applications*, Vielstich, W.; Gasteiger, H.; Lamm, A.; Eds. **2003**; Wiley, New York; Chap. 30, Vol. 3, 351-369; b) Arcella, V.; Ghielmi, A.; Tommasi, G.; *Ann. New-York Acad. Sci*; **2003**, 984, 226; c) Mauritz, K. A.; Moore, R. B. *Chemical Reviews*, **2004**, 104, 4535; d) Hickner, M. A.; Ghassemi, H.; Kim, Y. S.; Einsla, B. R.; McGrath, J. E.; *Chemical Reviews*, **2004**, 104, 4587; e) Souzy, R.; Ameduri, B.; *Prog. Polym. Sc.* **2005**, 30, 644; f) Groult, H.; Nakajima, T.; *Fluorinated Materials for Energy Conversion*, **2005**, Elsevier, Amsterdam; h) Yoshitake, M.; Watakabe, A.; *Prog. Polym. Sci.*, **2008**, 215, 127.

234 Albin, J. R.; Gallagher, G.A.; *US Patent* 3,136,745 **1964** (assigned to DuPont).

235 Otazaghine, B., Sauguet, L.; Boucher, M. ; Ameduri, B.; *Eur. Polym. J*, **2005**, 41, 1747.

236 Schuman, P.D.; *NASA contract Reports – 93172 (1966)* (Chem. Abstr. 71,92434m).

237 Ameduri, B.; Boutevin, B.; Armand, M.; Boucher, M.; Eur. Pat. 1,242,485 **2004**; (assigned to Hydro-Quebec).

238 Yamabe, M.; Kojima, G.; Wachi, H.; Kodama, S.; *US Patent*, 4,418,186 **1983** (assigned to Asahi Glass Co.).

239 Tatemoto, M.; Amano, T.; *Eur. Patent* 77,998 **1982** (assigned to Daikin).

240 Worm, A.T.; Veretennikov, N.V.; Sokolov, S.V.; *US Patent* 6,294,627 1999 (assigned to 3M).

241 Hung, M.H., Ameduri, B.; Boyer C.; US Previsional Patent DWO 0,139 USNA **2008**, (assigned to DuPont Performnace Elastomers)

242 Kostov, G.; Seabrook, S.; Hung, M. H.; Ameduri, B.; US Previsional Patent DWO 0,256 USNA **2008**, (assigned to DuPont Performance Elastomers)

243 Jaacks, A; *Makromol. Chem.*, **1972**, 161, 161.

244 Boyer C.; Ameduri, B.; Hung, M.H. (in preparation)

245 a) Feiring, A.E.; Doyle, C.M.; Roelofs, M.G.; Farnham, W.B.; Bekiaran, P.G.; Blair, H.A.K.; PCT WO 45,048 **1999** and US 6,667,377 **2003** (assigned to DuPont); b) Bekiaran, P.G.; Doyle, C.M.; Farnham, W.B.; Feiring, A.E.; Morken, P.A.; Roelofs, M.G.; Marshall, W.J.; *J. Fluorine Chem.* **2004**, 125, 1187.

246 B. Ameduri, M. Armand, A. Manseri, and M. Boucher, *Eur. Pat.*1,252,205 **2005** and US 014,889 **2006** (assigned to Hydro-Quebec).

247 Sauguet, L.; Ameduri, B.; Boutevin, B.; *J. Polym. Sc., Part A, Polym. Chem.*; **2007**, 45, 1814.

248 Emery, M.; Frey, M.; Hamrock, S.; Haugen, G.; Lochhaas, K.; Pierpont, D.; Schaberg, M.; Yandrasits, M.; *Electr. Chem. Soc. Trans.* **2007**, 11, 3; proceedings of the 212th Meeting of the Electr. Chem. Soc., Washington, Oct 7-12, **2007**.

249 Ezzel, B. R.; Carl, W.P.; *Eur. Pat.* EP 289,869 **1988** (assigned to Dow Chemical Corp.).

250 Connolly, D.J.; Gresham, W.F.; *US Patent* 3,282,875 **1966** (assigned to DuPont).

251 Ameduri, B.; Armand, M; Manseri, A.; Boucher, M. *Eur. Pat.* 1,242,486 **2004** (assigned to Hydro-Quebec).

252 DesMarteau, D.D.; *US Patent* 5,463,005 **1995** (assigned to Gas Research Institute).

253 Sauguet, L.; Ameduri, B.; Boutevin, B.; *J. Polym. Sc. Part A, Polym. Chem.* **2006**, 44, 4566.

254 Hung, M.-H.; Farnham, W.B.; Feiring, A.E.; Rozen, S.; “ *Functional Fluoromonomers and Fluoropolymers* ”, In : *Fluoropolymers : Synthesis*, 1, (Cassidy, P.E.; Hougham, G.; Johns, K.; Davidson, T.; eds); **1999**, chapter 4, pp. 51-66, Kluvert, New-York.

255 Ohmori, A.; Tomihashi, N.; Inukai, H.; Shimizu, Y. ; *Eur. Pat. Appl.* 0,138,091 **1984** (assigned to the Daikin Kogyo Co. Ltd.).

- 256 Ameduri, B.; Boutevin, B.; Kostov, G.; Petrova, P.; *J. Fluorine Chem.*, **1998**, 92, 69.
- 257 Mohtasham, J.; Cox, D.G.; Burton, D.J.; Gard, G.L.; *J. Fluorine Chem.*, **1989**, 42, 119.
- 258 Burton, D.J.; Tarumi, Y.; Heinze, P.L.; *J. Fluorine Chem.*, **1990**, 50, 257.
- 259 Ameduri, B.; Boutevin, B.; Petrova, P.; Fruchier, A.; Kostov, G.; *J. Fluorine Chem.*, **1998**, 89, 167.
- 260 Dolbier Jr, W. R.; Rong, X.X.; Barberger, M.D.; Koroniak, H.; Smart, B.E.; Yang, Z.Y.; *J. Chem. Soc., Perkin Trans.*, **1998**, 2, 219.
- 261 a) Hu, C.M.; Hu, G.S.; Qiu, Y.L.; Chen, J.; *J. Fluorine Chem.*, **1994**, 66, 171; b) Ameduri, B.; Boutevin, B.; Kostov, G.; Petrova, P.; *J. Fluorine Chem.*, **1998**, 92, 77.
- 262 a) Procida, F.P.; Pedersen, S.S.; Carstensen, P. US patent 4,138,462 **1979**, (assigned to Aktieselskabet Nordiske Kabel- Traadfabriker); b) Breazeale, A.F., Eur. Pat 11853, **1988** (assigned to (du Pont de Nemours)); c) Hung, M.-H.; Subramanyam, V.; Eur. Pat. Appl. 729,940 **1996** (assigned to du Pont Dow Elastomers); d) Sugiyama, N.; Watakabe, A.; Yokostuka S.; Hiroi, A.; Naritomi, M.; Shirota, N.; Aosaki, K.; Nakamura, M.; US patent RE37,022 **2001** (assigned to Asahi Glass Ltd.); e) Ameduri, B.; Manseri, A.; Boucher, M.; US 0,097,675 A1 **2004** (assigned to Hydro-Quebec).
- 263 Ameduri, B.; Boutevin, B.; Petrova, P.; Kostov, G.; *J. Fluorine Chem.*, **1999**, 93, 139.
- 264 Ameduri, B.; Boutevin, B.; Bauduin, G.; Petrova, P.; Kostov, G., *Macromolecules*, **1999**, 32, 4544.
- 265 Ameduri, B.; Boutevin, B.; Petrova, P.; Kostov, G.; *Design. Monomers Polym.* **1999**, 2, 267.
- 266 Petrova, P.; Ameduri, B.; Boutevin, B.; Kostov, G.; *US Patent* 6,753,392 **2004** (assigned to Solvay).
- 267 Brisdon, A., Banger, K.K.; *J. Fluorine Chem.*, **1999**, 100, 35.
- 268 a) Lannuzel, T; Guiot, J.; Ameduri, B.; Boutevin, B.; US Patent 0,160,972 A2 **2006** (assigned to Solvay S.A.); b) Guiot, J.; Ameduri, B.; Boutevin, B.; Lannuzel, T.; *J. Polym. Sc. Part A, Polym. Chem.* **2006**, 44, 3896.
- 269 Tayouo, R.; David, G.; Boutevin, B.; Ameduri, B.; in preparation.
- 270 Guiot, J.; Ph D dissertation, **2003** (University of Montpellier)
- 271 a) Greenley, R.Z.; "Free Radical Copolymerization Reactivity Ratios" in Brandrup, J.; Immergut, E.H.; eds, *Polymer Handbook*, **1989**, 3rd edition, Wiley Intersciences, New-York; b) Greenley, R.Z.; "Q and e Values for Free radical Copolymerization of Vinyl Monomers and Telogens" in Abe, A.; Bloch, D.R.; Immergut, E.H.; eds, *Polymer Handbook*, **1999**, 4th edition, Wiley Intersciences, New-York; vol. 2; pp 309-378.

272 Jap. Pat. 0,228,218 **2000** (assigned to Daikin).

273 Ameduri, B.; Boutevin, B.; Guiot, J.; WO 081,169 **2003** and Eur. Pat. 1,599,436 **2004** (assigned to Centre National de la Recherche Scientifique).

274 a) Ito, H.; Giese, B.; Engelbrecht, R.; *Macromolecules*, **1984**, 17, 2204; b) McElroy, K.T.; Purrington, S.T.; Bumgardner, C.L.; Burgess, J.P.; *J. Fluorine Chem.*; **1999**, 95, 117.

275 Watanabe, T., Momose, T., Ishigaki, I., Okamoto J. *J. Polym. Sci. Polym. Lett Ed.* **1981**, 19, 599.

276 Souzy, R.; Guiot, J.; Ameduri, B.; Boutevin, B.; Paleta, O.; *Macromolecules*, **2003**, 36, 9390.

277 Haas, H.C.; Norman, N.W.; US Pat. 3,444,150 **1969** (assigned to Polaroid Corp.)

278 Haas, H.C.; Mc Donald R.L.; *J. Polym. Sci. A1*; **1969**, 633.

279 Narita, T.; Hagiwara, T.; Hamana, H.; Ogawa, H.; Endo, S.; *Polymer J.*, **1990**, 22, 162.

280 Baradie, B.; Shoichet, M.S.; *Macromolecules*, **2002**, 35, 3569.

281 a) Panchalingam, V; Reynolds, J.R.; *Polym. Prepr.* **1988**, 179; b) Panchalingam, V; Reynolds, J.R.; *J. Polym. Sci.; Part C; Polym. Lett.*, **1989**, 27, 201.

282 Boutevin, B.; Furet, Y.; Hervaud, Y.; Rigal, G.; *J. Fluorine Chem.*, **1994**, 69, 11.

283 a) Melville, H. W.; Sewell, P. R.; *Makromol. Chem.*, **1959**, 32, 139; b) Morishima, Y.; Fujisawa, K.; Nozakura, S.; *J. Polym. Sci., Polym. Lett. Ed.*; **1978**, 16, 141; c) Starnes, W. H. Jr.; Chung, H.; Benedikt, G. M.; *Polym. Prepr. (Amer. Chem. Soc., Div. Polym. Chem.)* **1993**, 34, 604.

284 Meskini, A.; Raihane, M.; Ameduri, B.; Seytre, G.; in preparation

285 Kashio, H.; Horie, K., Suzuki, F., Eur. Patent 0,751,157 **1996** (assigned to Kureha Ltd. Co).

286 Kappler, P.; Perillon, J.- L.; Boutevin, B.; Parisi, J.-P. ; Eur. Pat. Appl. EP 493172 A1 **1992** (assigned to Elf Atochem S.A.).

287 a) Tournut, C.; Kappler, P.; Perillon, J.-L. ; *Fluorine in Coatings* Conference, Salford, UK, Sept. 28-30, **1994**, Paper 11 (Chem. Abstr. 124:120205); b) Tournut, C.; Kappler, P.; Perillon, J.-L.; *Surface Coatings International*, **1995**, 78, 99; c) Barbucci, A.; Pedroni, E.; Perillon, J.-L.; Cerisola, G.; *Prog. Organ. Coatings*, **1996**, 29, 7.

288 Kappler, P.; Perillon, J.-L.; Baudrand, M. EP 599712 A1 **1994** (assigned to Elf Atochem).

- 289 a) Kappler, P.; Perillon, J.-L.; Savary, C.; Eur. Pat. Appl. 685,499 A1 **1995** (assigned to Elf Atochem); b) Kappler, P.; Perillon, J.-L.; Savary, C.; Eur. Pat. Appl., EP 750,014 **1996** (assigned to Elf Atochem).
- 290 Kappler, P.; Perillon, J.- L. ; Eur. Pat. Appl. EP 481,849 A1 **1992** (assigned to Atochem).
- 291 Kappler, P.; Perillon, J.-L.; Baudrand, M.; French patent FR 2690449 A1 **1993** (assigned to Elf Atochem SA).
- 292 Tournut, C.; *Macromol. Symp.*, **1994**, 82, 99.
- 293 Tournut, C.; “*Thermoplastic copolymers of vinylidene fluoride*”, in Scheirs, J., ed. *Modern Fluoropolymers* **1997**, pp577-596; Wiley, Chichester
- 294 Priex® <http://www.solvayplastics.com/aboutsolvayplastics/experienceinnovation/priex/> consulted on September 25th, 2008.
- 295 Kynar® ADX <http://www.arkema-inc.com/index.cfm?pag=1049> consulted on October 6th, 2008.
- 296 a) Chandraskhan, S.; Mueller, M.B.; US Patent 3,706,723 **1972** (assigned to Allied Corp.); b) Minhas, P.S.; Petrucelli, F.; *Plast. Eng*, **1977**, 33, 60.
- 297 a) Pochan, J. M.; Hinman, D. F.; Froix, M. F.; Davidson, T., *Macromolecules*, **1977**, 10, 113; b) Froix, M. F.; Goedde, A. O.; Pochan, J.M.; *Macromolecules*, **1977**, 10, 778; c) Litt, M.H.; Lando, J. B.; *J. Polym. Sc. Polym. Phys. Ed.*, **1982**, 20, 535.
- 298 Ameduri, B.; Boutevin, B.; *Well Architected Fluoropolymers: Synthesis, Properties and Applications*; **2004**, Elsevier, Amsterdam; pp 211-213.
- 299 Sorokin, A.D.; Volkova, E.V.; Naberezhnykh, R.A.; *Radiat. Khim.*, **1972**, 2, 295.
- 300 a) Caporiccio, G.; Sianesi, D.; *J. Polym. Sci., Part A1*, **1968**, 6; b) Caporiccio, G.; Sianesi, D.; *Chim. Ind.*, **1970**, 52, 37.
- 301 Caporiccio, G.; *Chem. Corsi*, **1966**,12, 56.
- 302 Ameduri, B.; Bauduin, G.; *J. Polym. Sc., Part A, Polym. Chem.* **2003**, 41, 3109.
- 303 Moggi, G.; Bonardelli, P.; Bart, J.C.J.; *J. Polym. Sci. Part A, Polym. Chem.*, **1984**, 22, 357.
- 304 Moggi, G.; Bonardelli, P.; Russo, S.; *6th Conference Conv. Ital. Sci. Macromol.*, **1983**, 2, 405.
- 305 Bonardelli, P.; Moggi, G.; Turturro, A. *Polymer* **1986**, 27, 905.
- 306 Gelin, M. P.; Ameduri, B.; *J. Fluorine Chem.*, **2005**, 126, 577.
- 307 Beginn, U.; Najjar, R.; Ellmann, J.; Vinokur, R.; Martin, R.; Moeller, M.; *J. Polym. Sci., Part A: Polym. Chem.*, **2006**, 44, 1299.

- 308 Roberts, G. W.; Ahmed, T. S.; DeSimone, J. M.; Proceedings of the "Fluoropolymers 2008 Conference", Charleston, SC, **2008**, Oct. 19-22.
- 309 Guiot, J.; Ameduri B.; Boutevin, B.; *J. Polym. Sci., Part A, Polym. Chem.*; **2002**, *40*, 3634.
- 310 Khodzhaev, S.G.; Yusupbekova, F.Z.; Yul'Chibaev, A.A.; *Sb. Nauchn. Tr.- Tashk. Gos.*, **1981**, *667*, 34 (Chem. Abstr. 97, 163545).
- 311 Guiot, J.; Ameduri, B.; Boutevin, B.; *Eur. Polym. J.*, **2003**, *39*, 887.
- 312 David, G.; Boyer, C.; Tonnar, J.; Ameduri, B.; Lacroix Desmazes, P.; Boutevin, B.; *Chem. Rev.*, **2006**, *106*, 3936.
- 313 Hansen, N. M.L.; Jankova, K.; Hvilsted, S.; *Eur. Polym. J.*, **2007**, *43*, 255.
- 314 Bokar, S.; Sen, A.; *Macromolecules*, **2005**, *38*, 3029.
- 315 Ameduri, B.; Boyer, C.; *Japanese Patent* 214,420 **2008** and 51,201 **2007** (assigned to Tosoh F-Tech Inc.) (Chem. Abstr. 2008:1122917).
- 316 Severac, R.; PhD dissertation, University of Montpellier, **2003**.
- 317 Sauguet, L.; PhD dissertation, University of Montpellier, **2005**.
- 318 Kostov, G.; Ameduri, B.; Brandstadter, S.; *PCT/US Appl. 017425* **2007** (assigned to Great Lakes-Chemtura, Chem. Co.).
- 319 a) Davies, K.A.; Matyjaszewski, K.; *Adv. Polym. Sci.*; **2002**, *159*, 1 ; b) Hadjichristidis, N.; Pispas, S. ; *Prog. Polym. Sc.*, **2006**, *200*, 37.
- 320 Moggi, G.; Modena, S.; Marchionni, G.; *J. Fluorine Chem.*, **1990**, *49*, 141.
- 321 Gelin, M. P.; Ameduri, B.; *J. Polym. Sci., Part A, Polym. Chem.*; **2003**, *41*, 160.
- 322 Yang, Y., Shi, Z., Holdcroft S., *Eur. Polym. J.* **2004**, *40*, 531.
- 323 a) Modena, S.; Pianca, M.; Tato, M.; Moggi, G.; *J. Fluorine Chem.*, **1989**, *43*, 15; b) Belfield, K.D.; Abdel-Sadek, G.G.; Huang, J. T., Robert, X.; Abstracts of Papers, 223rd ACS National Meeting, Orlando, FL, United States, **2002**, April 7-11, POLY-192.
- 324 Yang Y., Shi Z., Holdcroft, S.; *Macromolecules*, **2004**, *37*, 1678.
- 325 a) Tatemoto, M.; Nakagawa, T.; German Patent 2,729,671 **1978** (assigned to Daikin Kogyo Co Ltd Jap) (Chem. Abst. 88 137374m); b) Tatemoto, M.; Nakagawa, T.; US Patent 4,158,678 **1979** (assigned to Daikin Kogyo Co Ltd Jap).
- 326 Tatemoto, M.; Tomoda, M.; Ueta, Y.; *Ger. Patent* DE 29,401,35 **1980** (assigned to Daikin Kogyo Co Ltd Jap) (Chem. Abst. 93 27580).
- 327 Tatemoto, M.; Morita, S.; *Eur. Pat.* 27,721 **1981** (assigned to Daikin Kogyo Co Ltd Jap).
- 328 Valade, D.; Boyer, C.; Ameduri, B.; Boutevin, B.; *Macromolecules*, **2006**, *39*, 8639.

- 329 Boyer, C.; Valade, D.; Sauguet, L.; Ameduri, B.; Boutevin, B.; *Macromolecules*, **2005**, *38*, 10353.
- 330 Zhang, Z.; Ying, S.; Shi, Z.; *Polymer*, **1999**, *40*, 1341.
- 331 Silverman, E.; Destarac, M.; Matyjaszewski, K.; Ameduri, B.; Boutevin, B.; *Macromolecules*, **2000**, *33*, 4613.
- 332 Shi, Z.; Holdcroft, S.; *Macromolecules*, **2004**, *37*, 2084.
- 333 Tsang, E. M. W.; Zhang, Z.; Shi, Z.; Soboleva, T.; Holdcroft, S.; *J. Amer. Chem. Soc.*; **2007**, *129*, 15106.
- 334 Rubatat, L.; Shi, Z.; Diat, O.; Holdcroft, S.; Frisken, B.J.; *Macromolecules* **2006**, *39*, 720.
- 335 Jankova, K.; Kostov, G.; Ameduri, B.; Hvilsted, S.; in preparation.
- 336 Xu, K.; Li, K. ; Khanchaitit, P.; Wang, Q.; *Chem Mater.*, **2007**, *19*, 5937.
- 337 Momose, T.; Tomiie, K.; Harada; H.; Miyachi, H.; Kato, H.; *Eur. Patent* 140,544 **1985** (assigned to Chlorine Engineers Corp.).
- 338 Brondino, C.; Boutevin, B.; Parisi, J.P.; Schrynmackers, J.; *J. Appl. Polym. Sc.*, **1999**, *72*, 611.
- 339 Robin, J.J.; *Adv. Polym. Sc.*, **2004**, *167*, 35.
- 340 Dargaville, T. R.; George, G. A.; Hill, D. J. T.; Whittaker, A. K.; *Prog. Polym. Sci.*, **2003**, *28*, 1355.
- 341 a) Porte-Durrieu, M. C.; Aymes-Chodur, C.; Betz, N.; Brouillaud, B.; Rouais, F.; LeMoel, A.; Baquey, C.; *Nucl. Inst. Meth. Phys. Res. B*, **1997**, *131*, 364 ; b) Porte-Durrieu, M. C.; Aymes-Chodur, C.; Betz, N.; Baquey, C.; *J. Biomed. Mater. Res.*, **2000**, *52*, 119.
- 342 Clochard, M.C.; Begue, J.; Lafon, A.; Caldemaison, D.; Bittencourt, C.; Pireaux, J.J.; Betz, N.; *Polymer*, **2004**, *45*, 8683.
- 343 Muller, M.; Oehr, C.; *Surf. Coat. Techno.*, **1999**, *116-119*, 802.
- 344 Ennari, J.; Hietala, S.; Paronen, M.; Sundholm, F.; Walsby, N.; Karjalainen, M.; Serimaa, R.; Lehtinen, T.; Sundholm, G.; *Macromol. Symp.*, **1999**, *146*, 41.
- 345 Kaur, S.; Ma, Z.; Gopal, R.; Singh, G.; Ramakrishna, S.; Matsuura, T.; *Langmuir*, **2007** *23*, 13085.
- 346 Ameduri, B.; Boutevin, B.; *Well Architected Fluoropolymers: Synthesis, Properties and Applications*; **2004**, Elsevier, Amsterdam; Chapter 5; pp 347-454.
- 347 Boutevin, B.; Pietrasanta, Y. ; Robin, J.J.; *Eur. Polym. J.*, **1991**, *27*, 815.
- 348 Zeppenfield, G.; *Makromol. Chem.*, **1966**, *90*, 169.
- 349 a) Ying, L.; Wang, P.; Kang, E.T.; Neoh, K.G.; *Macromolecules*, **2002**, *35*, 673; b) Ying, L.; Kang, E.T.; Neoh, K.G.; *J. Membrane. Sci.*, **2002**, *208*, 361.

- 350 Boutevin, B.; Serdani, A.; Robin, J.J.; *Eur. Polym. J.*, **1992**, *28*, 1507.
- 351 Costello, C. A.; McCarthy, T. J.; *Macromolecules*; **1987**, *20*, 2819.
- 352 a) Griesser, H. J.; Da, Y.; Hughes, A. E.; Gengenbach, T. R.; Mau, A. W. H.; *Langmuir*; **1991**, *7*, 2484; b) Golub, M. A.; Lopata, F. S.; Finney, L. S.; *Langmuir*; **1994**, *10*, 3629; c) Chan, C. M.; Ko, T. M.; Hiraoka, H.; *Surf. Sci. Rep.*; **1996**, *24*, 1.
- 353 Tian, J.; Xue, Q. J. *J. Appl. Polym. Sci.*; **1998**, *69*, 435.
- 354 Vasilets, V. N.; Hirata, I.; Iwata, H.; Ikada, Y. *J. Polym. Sci. Part A: Polym. Chem.*; **1998**, *36*, 2215.
- 355 Mathieson, I.; Brewis, D. M.; Sutherland, I.; Cayless, R. A.; *J. Adhes.*; **1994**, *46*, 49.
- 356 Everett, M. L.; Hoflund, G. B. *J. Polym. Sci. Part A: Polym. Chem.*; **2005**, *43*, 552.
- 357 Mascia, L.; Hashim, K.; *J. Appl. Polym. Sci.*, **1997**, *66*, 1911.
- 358 Liu, Y. ; Lee, J.Y.; Kang, E.T.; Wang, P.; Tan, K.L.; *React. Funct. Polym.*; **2001**, *47*, 201.
- 359 Danks, T.N.; Slade, R.C.T.; Varcoe, J.R.; *J. Mater. Chem.*, **2002**, *12*, 3371.
- 360 Danks, T.N.; Slade, R.C.T.; Varcoe, J.R.; *J. Mat. Chem.*, **2003**, *13*, 712.
- 361 Bressy Brondino, C.; Boutevin, B.; Hervaud, Y.; Gaboyard, M.; *J. Appl. Polym. Sc.*, **2002**, *83*, 2277.
- 362 Lafitte, B.; Jannasch, P. In *Advances in Fuel Cells*; Zhao, T., Kreuer, K. D., Nguyen, T., Eds.; **2007**; Elsevier Ltd.: Oxford, UK, Vol. 1, Chapter 3, pp 119-185.
- 363 Riches, J.; Knutsen, L.; Morrey, E.; Grant, K.; *Fire Safety*, **2002**, *37*, 287.
- 364 a) Kato, M.; Akiyama, K.; Yamabe, M.; *Reports Res. Lab. Asahi Glass Co.*; **1983**, *33*, 135; b) Pedersen, S.D.; Qiu, W.; Qiu, Z.-M.; Kotov, S.V.; Burton D.J.; **1996**, *25*; c) Yamabe, M.; Akiyama, K.; Akatsuka, Y.; Kato, M.; *Eur. Polym. J.*, **2000**, *69*, ; d) Creager S.; Chen, J.; Sharif, I.; Desmarteau, D.; Proceedings of the “Fluoropolymer Conference **2008**”; Charleston, S.C. October, 19-22.
- 365 Saarinen, V.; Himanen, O.; Kallio, T.; Sundholm, G.; Kontturi, K; *J. Power Sources*; **2007**, *163*, 768.
- 366 Holmberg, S.; Lehtinen, T.; Näsman, J.; Ostrovskii, D.; Paronen, M.; Serimaa, R.; Sundholm, F.; Sundholm, G.; Torell, G.; Torkkeli, M.; *J. Mater.Chem.*, **1996**, *6*, 1309.
- 367 Shen, Y.; Qiu, X.; Shen, J.; Xi, J.; Zhu, W.; *J. Power Sources*, **2006**, *161*, 54.
- 368 Shen, M.; Roy, S.; Kuhlmann, J.W.; Scott, K.; Lovell, K.; Horsfall, J.A.; *J. Membr. Sci.* **2005**, *268*, 121.
- 369 Soresi, B.; Quartarone, E.; Mustarelli, P.; Magistris, A.; Chiodelli, G.; *Solid State Ionics* **2004**, *166*, 383.

- 370 Nasef, M.M.; Saidi, H.; Dahlan, K.Z.M.; *Nucl. Instr. Method. Phys. Res. B*; **2007**, *265*, 168.
- 371 Chen, J.; Asano, M.; Maekawa, Y.; Yoshida, M.; *J. Membrane Sci.*; **2006**, *277*, 249.
- 372 Nasef, M.M.; Zubir, N.A.; Ismail, A.F.; Khayet, M.; Dahlan, K.Z.M.; Saidi, H.; *J. Membr. Sci.* **2006**, *268*, 96.
- 373 Lin, D.; Chen, Y.; Zhang, M.; He, X.; *J. Appl. Polym. Sci.*, **2006**, *101*, 3704.
- 374 Chen, Y. ; Liu, D.; Mang, N.; *Surf. Rev. Lett.*; **2005**, *12*, 709.
- 375 Gelin, M. P.; Ameduri, B.; *J. Fluorine Chem.*, **2003**, *119*, 53.
- 376 Katoh, E.; Kawashima, C.; Ando, I.; *Polymer J.*; **1995**, *27*, 645.
- 377 Holmberg, S.; Holmlund, P.; Nicolas, R.; Wilen, C.-E.; Kallio, T.; Sundholm, G.; Sundholm, F.; *Macromolecules*, **2004**, *37*, 9909.
- 378 Chen, Y.; Liu, D.; Deng, Q.; He, X.; Wang, X.; *J. Polym. Sci. Part. A, Polym. Chem.*, **2006**, *44*, 3071.
- 379 a) Chen, Y.; Ying, L.; Yu, W.H.; Kang, E.T.; Neoh, K.G.; *Macromolecules*, **2003**, *36*, 9451; b) Ying, L.; Yu, W.H.; Kang, E.T.; Neoh, K.G.; *Langmuir*, **2004**, *20*, 6032.
- 380 Holmberg, S.; Holmlund, P.; Wilen, C.E.; Kallio, T.; Sundholm, G.; Sundholm, F.; *J. Polym. Sci. Part A : Polym. Phys*, **2002**, *40*, 591.
- 381 Zhang, M.; Russell, T.P.; *Macromolecules* **2006**, *39*, 3531.
- 382 Kim, Y.W.; Lee, D.K.; Lee, K.J.; Kim, J.H.; *J. Membrane Sci.*, **2008**, *313*, 315.
- 383 Boyer, C.; Sauguet, L.; Ameduri, B.; Boutevin, B.; *Macromolecules*, **2006**, *39*, 9087.
- 384 a) Hester, J.F.; Banerjee, P.; Won, Y.Y.; Akthakul, A.; Acar, M.H.; Mayes, A.M.; *Macromolecules*, **2002**, *35*, 7652; b) Inceoglu, S.; Olugebefola, S.C.; Acar, M.H.; Mayes, A.M.; *Design. Monom. Polym.*, **2004**, *7*, 181; c) Akthakul, A.; Hochbaum, A.I.; Stellacci, F.; Mayes, A.M.; *Adv. Mat.*, **2005**, *17*, 532; d) Takahara, Proceedings of the “Fluoropolymers Conference”, Charleston, SC; **2008**, October 19-22.
- 385 Mayes, A. M.; Hester, J.F.; Banerjee, P.; Akthakul, A.; Intern. Demand PCT Int. Appl. WO 0,222,712 **2002** (assigned to Massachusetts Institute of Technology).
- 386 Kim, Y.W.; Choi, J.K.; Park, J.T.; Kim, J.H.; *Eur. Polym. J.*, **2008**, *44*, 932.
- 387 Rice, D.E.; *US Patent*, 3,461,155 **1969** (assigned to 3M).
- 388 Zhao, C.Y.; Zhou, R.; Pan, H.; Jin, X.; Qu, J.; Wu, C.; Jiang, X.; *J. Org. Chem.* **1982**, *47*, 2009.
- 389 Rice, D.E.; Sandberg, C.L.; *Polym. Prep.; Am. Chem. Soc.; Div. Polym. Sci.*, **1971**, *12*, 396.
- 390 Li, K.; Liang, S.; Lu, Y.; Wang, Q.; *Macromolecules*, **2007**, *40*, 4121.

391 a) SaintLoup, R.; Manseri, A.; Ameduri, B.; Lebret, B.; Vignane, P.; *French Demand* 0008082 **2002** (assigned to Commissariat à l'Energie Atomique); b) SaintLoup, R.; Manseri, A.; Ameduri, B.; Lebret B.; Vignane, P.; *Macromolecules* **2002**, 35, 1524.

392 SaintLoup, R.; Ameduri, B.; *J. Fluorine Chem.*, **2002**, 116, 27.

393 Manseri, A.; Boulahia, D.; Ameduri, B.; Boutevin, B.; *J. Fluorine Chem.*, **1997**, 81, 103.

394 Riley, M.O.; Kim, Y.K.; Pierce, O.R.; *J. Fluorine Chem.*, **1997**, 10, 85.

395 a) Boutevin, B.; Caporiccio, G.; Guida-Pietrasanta, F.; Ratsimihety, A.; *US Patent* 5,527,933 **1996** (assigned to Dow Corning); b) Boutevin, B.; Guida-Pietrasanta, F.; Ratsimihety, A.; Caporiccio, G.; *Main Group Metal Chem.*, **1997**, 20, 133.

396 Boutevin, B.; Caporiccio, G.; Guida-Pietrasanta, F.; Ratsimihety, A.; *Macromol. Chem. Phys.*; **1998**, 199, 61.

397 a) Ameduri, B.; Boutevin, B.; Guida-Pietrasanta, F.; Manseri, A.; Ratsimihety, A.; Caporiccio, G.; "Use of Fluorinated telomers for the Obtaining of Hybrid Fluorosilicones" in *Fluoropolymers, Synthesis*, Vol. 1 (G. Hougham, P.E. Cassidy, K. Johns and J. Davidson, eds), **1999**, Chapt. 5, pp. 67-79, Plenum Publi., New-York.

398 Guida-Pietrasanta, F.; Boutevin, B.; *Adv. Polym. Sci.*; **2005**, 179, 1.

399 Ameduri, B.; Boutevin, B.; *Well Architected Fluoropolymers: Synthesis, Properties and Applications*; **2004**, Elsevier, Amsterdam; Chapter 5; pp 314-327.

400 Souzy, R.; Boyer, C.; David, G.; Kostov, G.; Ameduri, B.; *ECS Transactions*; **2007**, 11, Part 1, Proton Exchange Membrane Fuel Cells, 15.

401 Capron, P.; Ameduri, B.; Boutevin, B.; Souzy, R.; WO 042994 A3 **2003** (assigned to CEA).

402 Taguet, A.; Ameduri, B.; Boutevin, B.; *J. Polym. Sci. Part A, Polym. Chem.* (in press; DOI: 10.1002/pola.23129).

403 Taguet, A.; Sauguet, L.; Ameduri, B.; Boutevin, B.; *J. Fluorine. Chem.*, **2007**, 128, 619.

404 Taguet, A.; Ameduri, B.; Boutevin, B.; *Fuel Cell*, **2006**, 5, 331.

405 Bonnet, A.; Lapprand, A.; Sebire, Pl. ; PCT Int. Appl. WO 017,789 **2008** (assigned to Arkema).

406 Liebler, L.; *Progr. Polym. Sci.*, **2005**, 30, 898.

407 Tournut, C.; Wolff, D.; *Materiaux & Techniques*, **1992**, 80, 46 (Chem. Abstr. 119:96780).

408 a) Bach, D.; Van Gool, G.; Steffens, J.; Proceedings of the "International Rubber Technology Conference **2003**", Cleveland, USA, Oct. 14-17; b) Dyneon Fluoroelastomer LTFE 6400X **2003**, Technical Information brochure.

TABLE CAPTIONS

Table 1: Main commercially available fluoroelastomers

Table 2: Monomer reactivity ratios for the copolymerization of VDF (A) with other fluoroalkenes (B).

Table 1: Main commercially available fluoroelastomers ^a

	HFP	PMVE	CTFE	P
VDF	<p><i>Daiel[®] G 801 and others (Daikin)</i></p> <p><i>Dyneon[®] Elastomer (3M/Dyneon)</i></p> <p><i>Tecnoflon[®] N/FOR (Solvay Solexis)</i></p> <p><i>SKF[®]-26 (Russia)</i></p> <p><i>Viton[®] A (DPE)</i></p>	-	<p><i>Dyneon[®] Elastomer (3M/Dyneon)</i></p> <p><i>SKF[®]-32 (Russia)</i></p> <p><i>Voltalef[®] (Arkema North America)</i></p>	-
TFE	-	<p><i>Daiel[®] Perfluoro (Daikin)</i></p> <p><i>Dyneon[®] Perfluoroelastomer PFE-80 (3M/Dyneon)</i></p> <p><i>Kalrez[®] Perfluoroelastomer (DPE)</i></p> <p><i>Tecnoflon[®] PFR (Solvay Solexis)</i></p>	-	<p><i>Aflas[®] 100 (Asahi Glass);</i></p> <p><i>Viton Extreme[®] TBR (DPE)</i></p>
VDF + TFE	<p><i>Daiel[®] G 901 and others (Daikin)</i></p> <p><i>Dyneon[®] Elastomer (3M/Dyneon)</i></p> <p><i>Tecnoflon[®] P/T/TN/FOR (Solvay Solexis)</i></p> <p><i>Viton[®] B/F/GF/GBL (DPE)</i></p>	<p><i>Daiel LT (Daikin)</i></p> <p><i>Dyneon[®] Low Temperature Fluoroelastomer LTFE-6400 (3M/Dyneon)</i></p> <p><i>Tecnoflon[®] PL (Solvay Solexis)</i></p> <p><i>Viton[®] GLT/GFLT (DPE)</i></p>	<p><i>Dyneon[®]Base Resistance Elastomer BRE 7200 (3M/Dyneon)</i></p>	<p><i>Aflas[®] 200 (Asahi Glass)</i></p>
	<p><i>Tecnoflon[®] BR (Solvay Solexis)</i></p> <p>(*)</p>	<p><i>Tecnoflon[®] VPL (Solvay Solexis)</i></p> <p>(**)</p>		

^a DPE: DuPont Performance Elastomers; CTFE: chlorotrifluoroethylene ($F_2C=CFCl$); HFP: hexafluoropropene ($F_2C=CF_2CF_3$); HPFP: 1-hydro-pentafluoropropene ($FHC=CF-CF_3$); P: propene ($H_2C=CHCH_3$); PMVE: perfluoromethyl vinyl ether ($F_2C=CFOCF_3$); TFE: tetrafluoroethylene ($F_2C=CF_2$); VDF: vinylidene fluoride (or 1,1-difluoroethylene) ($F_2C=CH_2$); X: cure site monomer ($XCY=CZ-R-G$; G: function).

(*) further comprising recurring units derived from hydrogenated olefin

(**) further comprising recurring units derived from particular perfluorovinylethers having catenary oxygen atoms in the pendant chain

Table 2: Monomer reactivity ratios for the copolymerization of VDF (A) with other fluoroalkenes (B).

Monomer B	r_A	r_B	$r_A r_B$	$1/r_A$	Reference
H ₂ C=CH ₂	0.05	8.5	0.42	20.00	299
H ₂ C=CHOCOCH ₃	-0.40	1.67	-0.67	-2.5	280
	0.50	2.0	1.00	2.0	270
H ₂ C=CHCF ₃	0.35	2.40	0.91	2.85	223
H ₂ C=C(CF ₃)CO ₂ H	0.33	0	0	3.03	191
H ₂ C=C(CF ₃)OAc	0.16	7.6	1.22	6.25	270
FCH=CH ₂	0.17	4.2 – 5.5	0.71 – 0.94	5.88	300
	0.20 – 0.43	3.8 – 4.9	0.76 – 2.11	2.33 – 5.00	301
H ₂ C=CFCF ₂ OR _F	0.38	2.41	0.92	2.63	302
F ₂ C=CHCF ₃	9.0	0.06	0.54	0.11	216
F ₂ C=CHC ₆ F ₁₃	12.0	0.90	10.80	0.08	220
F ₂ C=CHBr	1.2	0.4	0.48	0.83	228h
F ₂ C=CFH	0.70	0.50	0.35	1.43	143
	0.17	0.52	0.09	5.88	13a
CFBr=CF ₂	0.43	1.46	0.63	2.33	229a,303
CF ₃ -CF=CF ₂	6.70	0	0	0.15	304
	5.0	0	0	0.20	6
	2.45	0	0	0.40	305
	2.90	0.12	0.35	0.34	306
	5.13	0	0	0.19	41
	3.6	0	0	0.28	307
	3.6-4.6	0	0	0.22-0.28	156
	3.2	0	0	0.31	39
	3.3	0	0	0.86	308
	3.3	0	0	0.86	308
F ₂ C=CFOCF ₃	3.40	0	0	0.29	235
	1.06	0.11	0	0.94	200b

	2.53	0	0	0.39	244
$F_2C=CFOC_3F_7$	1.15	0	0	0.86	235
$F_2C=CFO(HFP)OC_2F_4SO_2F$	0.57	0.07	0.04	1.75	247
$CF_2=CFCH_2OH$	0.83	0.11	0.09	1.02	309
$CF_2=CF(CH_2)_2Br$	0.96	0.09	0.09	1.00	230c
$CF_2=CF(CH_2)_3OAc$	0.17	3.26	0.59	5.56	264
$F_2C=CF(CH_2)_3SAc$	0.60	0.41	0.25	4.07	265
$CF_2=CFCO_2CH_3$	0.30	0	0	3.33	276
$F_2C=C(CF_3)COF$	7.60	0.02	0.15	0.13	310
$F_2C=C(CF_3)OCOC_6H_5$	0.77	0.11	0.08	1.30	311
$CF_2=CF_2$	0.23	3.73	0.86	4.35	229a,303
	0.32	0.28	0.09	3.13	201

FIGURE CAPTIONS

Figure 1: ^{19}F nuclear magnetic resonance spectra of PVDF (upper: solid state and lower: liquid recorded in d-DMF)

Figure 2: main polymorphs of PVDF (reproduced with permission from Wiley & Sons, *Encycl. Polym. Sc. Tech.*, **2004**, 4, 510)

Figure 3: Lithium battery sketch (reproduced with permission from the American Chemical Society; Bouchet, R.; Lascaud, S.; Rosso, M.; *J. Electrochem. Soc.*, **2003**, 150, A1385).

Figure 4: Tensile stress/strain curves for PVDF/nylon-6 blends with various contents of organoclays⁹⁰ (reproduced with permission from *Amer. Chem. Soc.*, Fluoropolymer Conference 2008, Charleston, Oct. 19-22, 2008)

Figure 5: Cartoon showing the effect of the clay in PVDF/nylon-6 blends by melt compounding⁹⁰ (reproduced with permission from *Amer. Chem. Soc.*, Fluoropolymer Conference 2008, Charleston, Oct. 19-22, 2008)

Figure 6: Schematic representation of an elementary “membrane electrode assembly”, MEA, of a fuel cell

Figure 7 : scanning electron microscopic (SEM) pictures of membrane made of PVDF and SEBS without any compatibilizer (a) and with compatibilizer (b) and (c) (reproduced with permission from Elsevier; Mokrini, A.; Huneault, MA; *J. Power Sources*, **2006**, 154, 51).

Figure 8: Polarization curve of PVDF/PSSA membrane achieved from semi interpenetrated polymer network (reproduced with permission from Elsevier; Prakash, G.K.S. *et al.*; *J. Fluorine Chem.* **2004**, 125, 1217⁹⁸).

Figure 9: Electrochemical performance of a membrane composed of sulfonated PEEK (97.5 wt. %) / PVDF (2.5 wt. %) (full squares) compared to those of Nafion® (full circles); the temperature is not given; (reproduced with permission from Elsevier; Jung, H.J.; Park, J.K.; *Electrochim. Acta*, **2007**, 52, 7464).

Figure 10: Variation of the glass transition temperature (T_g) of PBI as a function of PBI/PVDF blend composition. The solid points are the experimentally obtained T_g values from the DSC study, and the dotted line is the calculated T_g curve according to the Gordon-Taylor equation with $k=1$ (reproduced with permission from the Amer. Chem. Soc.; Arunbabu, D. ; Sannigrahi, A.; Jana, T; *J. Phys. Chem. B* **2008**, *112*, 5305).

Figure 11: Tactile sensor for robotic applications (reproduced with permission from K. Takashima *et al.*, *Sensors and Actuators*, **2008**, *A 144*, 90).

Figure 12: Differential scanning calorimetry thermograms of poly(VDF-co-CTFE) copolymers containing various amounts of CTFE (reproduced with permission from Chung, M.; Zhang, Z.; Chalkova, E.; Wang, C.; Fedkin, M.; Sharma, S.; Lvov, S.; *Electr. Chem. Soc. Trans.*, **2007**, *11*, 35; proceedings of the 212th Meeting of the Electr. Chem. Soc., Washington (USA), Oct. 7-12, **2007**).

Figure 13: Dielectric constant of (a) poly(VDF-co-CTFE) (92/8 mol %) copolymer (melting temperature, $T_m= 145.0$ °C; Curie temperature, $T_c=$ non-assessed) and (b) poly(VDF-ter-TrFE-ter-CTFE) (65.6/26.7/7.7 mol %) terpolymer ($T_m= 123.6$ °C and $T_c= 23.8$ °C) (reproduced with permission from the *Amer. Chem. Soc.* Zhang, Z.; Mike Chung T.C.; *Macromolecules*, **2007**, *40*, 783¹²⁸).

Figure 14: Conductivity of new composite materials compared to Nafion[®] at 120 °C and different relative humidity (RH) (1 - Nafion[®] 115; 2 – 40 % poly(VDF-co-CTFE) copolymer / 60% sulfonated silicon dioxide; 3 - poly(VDF-co-CTFE)-g-SPETMS (reproduced with permission from Chung, M.; Zhang, Z.; Chalkova, E.; Wang, C.; Fedkin, M.; Sharma, S.; Lvov, S.; *Electr. Chem. Soc. Trans.*, **2007**, *11*, 35; proceedings of the 212th Meeting of the Electr. Chem. Soc., Washington (USA), Oct. 7-12, **2007**¹³⁸).

Figure 15: A three-dimensional plot of room temperature dielectric constants at 1 kHz for the P(VDF-CTFE-TrFE) terpolymers (reproduced with permission from the Amer. Chem. Soc. Lu, Y.; Claude, J.; Neese, B.; Zhang, Q.M.; Wang, Q.; *J. Amer. Chem. Soc.*, **2006**, *128*, 8120^{126a}).

Figure 16: Semi-crystalline or amorphous poly(VDF-co-HFP) copolymers according to the content of HFP in the copolymer (reproduced with permission from *Amer. Chem. Soc.*, Ahmed *et al.*, *Macromolecules*, **2007**, *40*, 9322¹⁵⁶)

Figure 17: Differential scanning calorimetry thermograms of poly(VDF-co-HFP) copolymers with different HFP contents (HMW and MMW stand for high molecular weight and medium molecular weights, respectively; reproduced with permission from Elsevier, J.M. Tarascon *et al.*, *Solid State Ionic*, **1996**, 86-88, 49¹⁶¹).

Figure 18: Polarization curves of: coated Nafion[®] (orange) and virgen Nafion[®] 117 (brown) at 30 °C (reproduced with permission from Elsevier; Cho *et al.*; *J. Power Sources*, **2006**, 159, 524).

Figure 19: Evolution of Lithium ion cells *versus* years

Figure 20: Conductivity as a function of the electrolyte uptake for low-porous PVDF and poly(VDF-co-HFP) copolymers (PVDF copolymer 2801) membranes (reproduced with permission from Elseveir; Michot, T.; Nishimoto, A.; Watanabe, M.; *Electrochim. Acta*, **2000**, *45*, 1347^{170b}).

Figure 21: The Li⁺ content of gel polymer electrolyte without SiO₂ (-O-) and with SiO₂ (-square-) dependence on the ionic conductivity (reproduced with permission from the *Amer. Chem. Soc.* (Wang *et al.* *J. Phys. Chem. B* **2004**, *108*, 1365¹⁸²)).

Figure 22: The two models proposed for the interaction between polymer and polycarbonate in the Nafion-Li/PVDF-HFP blend polymer electrolyte membrane (a) without SiO₂ and (b) with SiO₂. The fluorocarbon phase (FP), interfacial region (IR), and ionic clusters (IC) are shown in it (reproduced with permission from the *Amer. Chem. Soc.* (Wang *et al.* *J. Phys. Chem. B* **2004**, *108*, 1365¹⁸²)).

Figure 23: Evolution of $\ln[\text{VDF}]/[\text{VDF}]_0$ *versus* $\ln[\text{PMVE}]/[\text{PMVE}]_0$ for the radical copolymerization of VDF and PMVE in emulsion in the presence of IC₄F₈I. Feed composition in VDF and PMVE (mol-%) 90/10 in aqueous medium.

Figure 24: ^{19}F -NMR spectrum of the poly(VDF-co-methyl β,β -difluoroacrylate) copolymer (90 mol. % VDF in the feed; 86 mol. % VDF in copolymer); symbols $^{\circ}$ and $*$ represent the AB and A'B' systems, respectively. An unexpected slight high field shift of 2 ppm is noted.

Figure 25: Monomer-polymer copolymerization curves from the radical copolymerization of VDF with various comonomers (the full lines represent the theoretical curves)

Figure 26: ^{19}F NMR spectrum of poly(VDF-co-MAF) copolymer recorded in DMSO (NS=1024, D1=2s); feed mol. % VDF/ α -trifluoromethacrylic acid (MAF) = 90/10; in copolymer mol.% 94/6; MW= 57,350 g.mol $^{-1}$.

Figure 27: ^{19}F NMR spectrum of poly(VDF-co-PMVE) copolymer (recorded in d^6 acetone) obtained by Iodine transfer copolymerization of VDF and PMVE in the presence of $\text{C}_6\text{F}_{13}\text{I}$ (feed 50/50 in VDF/PMVE mol/mol, and 60/40% in copolymer).

Figure 28: Evolution of yield of ITP copolymerization of VDF and PMVE in the presence of $\text{C}_6\text{F}_{13}\text{I}$ (\square) or $\text{IC}_4\text{F}_8\text{I}$ (\blacklozenge) versus mol% PMVE in feed.

Figure 29: (A) SEC chromatograms of poly(VDF-*ter*-HFP-*ter*- $\text{F}_2\text{C}=\text{CFSF}_5$) terpolymers obtained by iodine transfer terpolymerization of VDF, HFP and $\text{F}_2\text{C}=\text{CFSF}_5$: (xx) ($[\text{C}_6\text{F}_{13}\text{I}]_0/([\text{VDF}]_0+[\text{HFP}]_0+[\text{F}_2\text{C}=\text{CFSF}_5]_0) = R_0 = 0.05$); (\blacksquare) $R_0 = 0.01$; (full line) ($R_0 = 0.005$), respectively. (B) Evolution of molecular weight (M_n , \blacksquare and \blacktriangle assessed by SEC and ^{19}F NMR, respectively) and polydispersity index (PDI, \bullet) versus $1/R_0$ ($R_0 = [\text{C}_6\text{F}_{13}\text{I}]_0/[\text{M}]_0$ where M represents the monomer concentrations. Experimental conditions: $[\text{Initiator}]_0 / [\text{VDF}+\text{HFP}+\text{SF}_5 \text{ monomer}]_0 = 0.01$ in the 1,1,1,3,3-pentafluorobutane at 75 $^{\circ}\text{C}$ for 6 hrs. The straight full line represents the theoretical curve (reproduced with permission of the American Chemical Society; Boyer *et al. Macromolecules*, **2008**, *41*, 1254¹⁹⁷).

Figure 30: Superposition of SEC chromatograms of poly(VDF-co-HFP) copolymer (70/30 in feed) in the presence of MX2 fluorinated xanthate; reaction time $t = 7\text{h}$, VDF (REMX2-1) and VDF/HFP (70/30 in feed) (REMX2-2); MX2 stands for $\text{C}_6\text{F}_{13}\text{C}_2\text{H}_4\text{C}(\text{O})\text{CH}(\text{CH}_3)$ -poly[(VDF)-co-(HFP)]-SC(S)OCH $_2$ CH $_3$ ³¹⁷.

Figure 31: Surface tension of aqueous solutions of synthesized fluorinated surfactants: Surf. A- $(\text{CF}_3)_2\text{CF}-\text{CH}_2-\text{CH}(\text{CF}_3)(\text{CH}_2)_3\text{SCH}_2\text{CO}_2(\text{CH}_2\text{CH}_2\text{O})_{13}\text{CH}_3$;

Surf. B- $(\text{CF}_3)_2\text{CF}(\text{TFP})\text{CH}_2\text{CH}_2\text{N}^+\text{C}_5\text{H}_5\text{I}$; Surf. C- $(\text{CF}_3)_2\text{CF}(\text{VDF})_2(\text{TFP})_3[\text{CH}_2\text{CH}(\text{OH})]_5\text{H}$.

Figure 32: Conductivities of Nafion® 117 and of membranes achieved from PSSA-*b*-PVDF-*b*-PSSA triblock copolymer as a function of the ion-exchange capacity (reproduced with permission from the Amer. Chem. Soc, *Chem. Mater.*, **2007**, *19*, 5937; Xu *et al.*³³⁶)

Figure 33: Proton conductivity *versus* the relative humidity of PSSA-*b*-PVDF-*b*-PSSA triblock copolymers and Nafion® 117 membranes; DS stands for degree of sulfonation (reproduced with permission from the Amer. Chem. Soc, Xu *et al.*; *Chem. Mater.*, **2007**, *19*, 5937³³⁶).

Figure 34: Variation of proton conductivity measured under 95 % relative humidity *versus* temperature for PSSA-*b*-PVDF-*b*-PSSA triblock copolymers and Nafion®117 membranes (reproduced with permission from the Amer. Chem. Soc, Xu *et al.*; *Chem. Mater.*, **2007**, *19*, 5937³³⁶).

Figure 35: Dependence of molecular weight (\blacklozenge) and polydispersity index (Δ) of PVDF-*g*-PS copolymer versus styrene conversion for the ATRP of styrene using poly(VDF-*co*-BDFO) copolymers as the macroinitiator. $[\text{DMF}]_0 : [\text{Styrene}]_0 : [\text{Macroinitiator}]_0 : [\text{HMTETA}]_0 : [\text{Cu}^{\text{I}}\text{Br}]_0 = 500 : 100 : 10 : 0.5 : 0.5$; $T = 90\text{ }^\circ\text{C}$.

BDFO, HMTETA and DMF stand for 8-bromo-1H,1H,2H-perfluorooct-1-ene, 1,1,4,7,10,10-hexamethyltriethylenetetramine and dimethylformamide, respectively (reproduced with permission of the American Chemical Society; Boyer, C. *et al.*; *Macromolecules*, **2006**, *39*, 9087³⁸³).

FIGURE 1

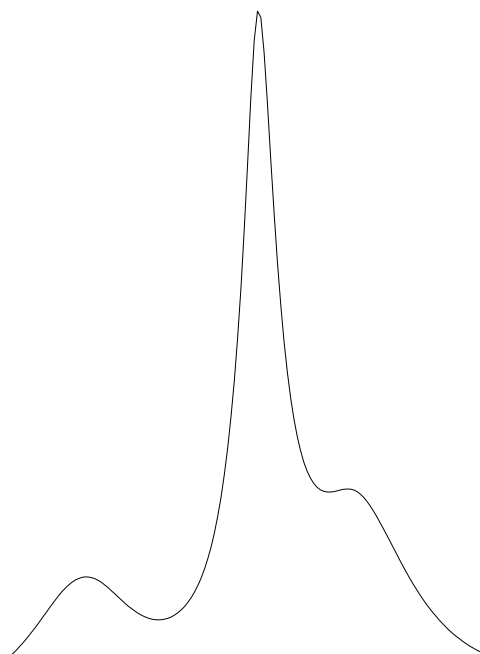

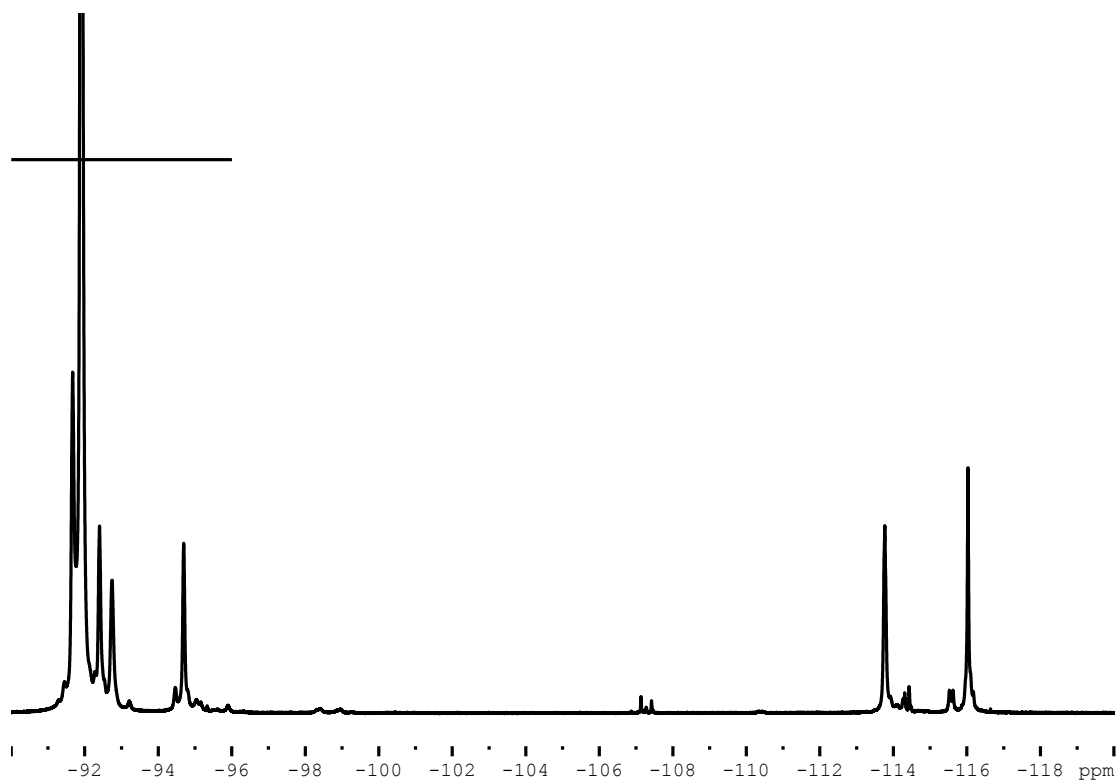

Figure 1: ^{19}F nuclear magnetic resonance spectra of PVDF (upper: solid state and lower: liquid recorded in $d\text{-DMF}$)

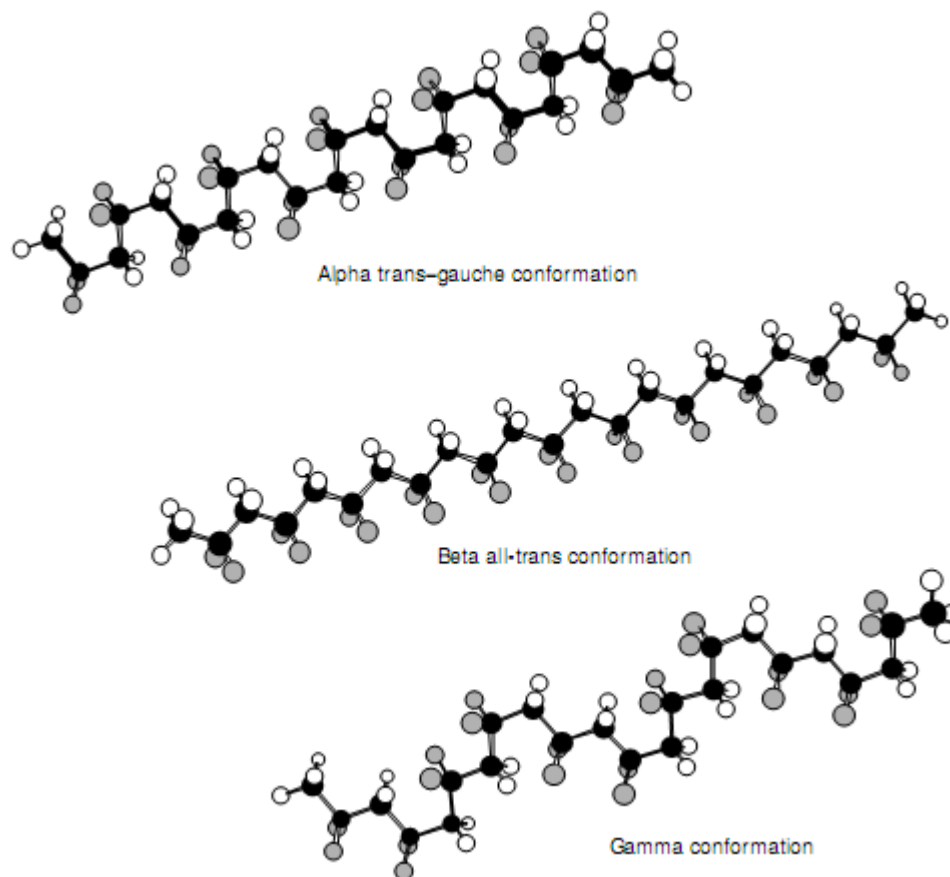

Figure 2: main polymorphs of PVDF (reproduced with permission from Wiley & Sons, *Encycl. Polym. Sc. Tech.*, **2004**, 4, 510)

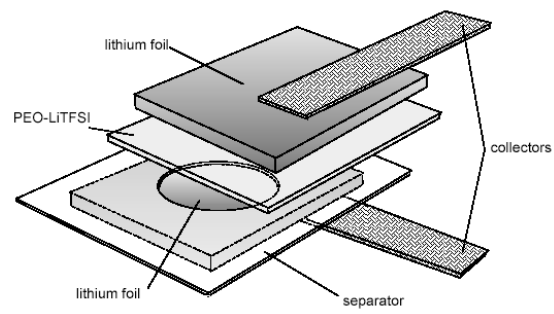

Figure 3: Lithium battery sketch (reproduced with permission from the American Chemical Society; Bouchet, R.; Lascaud, S.; Rosso, M.; *J. Electrochem. Soc.*, **2003**, *150*, A1385).

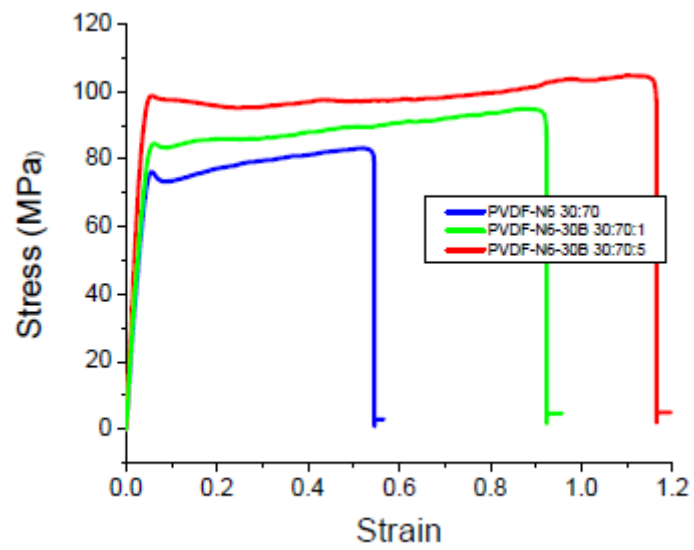

Figure 4: Tensile stress/strain curves for PVDF/nylon-6 blends with various contents of organoclays⁹⁰ (reproduced with permission from *Amer. Chem. Soc.*, Fluoropolymer Conference 2008, Charleston, Oct. 19-22, 2008)

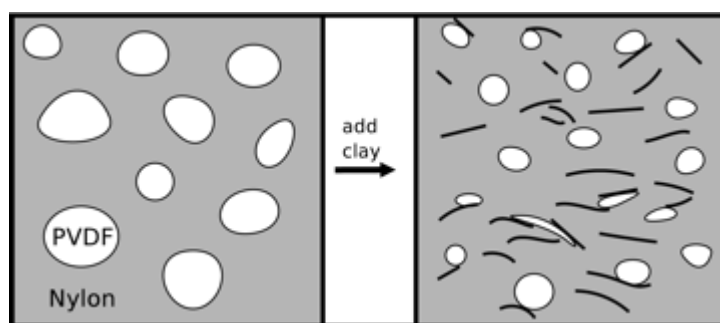

Figure 5: Cartoon showing the effect of the clay in PVDF/nylon-6 blends by melt compounding⁹⁰ (reproduced with permission from *Amer. Chem. Soc.*, Fluoropolymer Conference 2008, Charleston, Oct. 19-22, 2008)

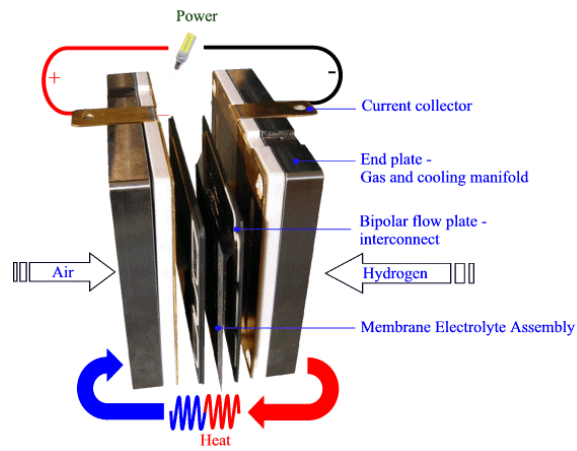

Figure 6: Schematic representation of an elementary “membrane electrode assembly”, MEA, of a fuel cell

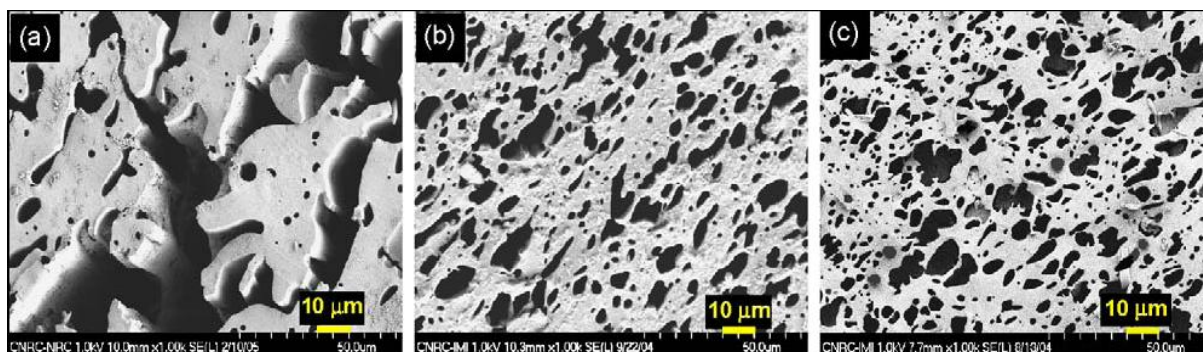

Figure 7 : scanning electron microscopic (SEM) pictures of membrane made of PVDF and SEBS without any compatibilizer (a) and with compatibilizer (b) and (c) (reproduced with permission from Elsevier; Mokrini, A.; Huneault, MA; *J. Power Sources*, **2006**, 154, 51).

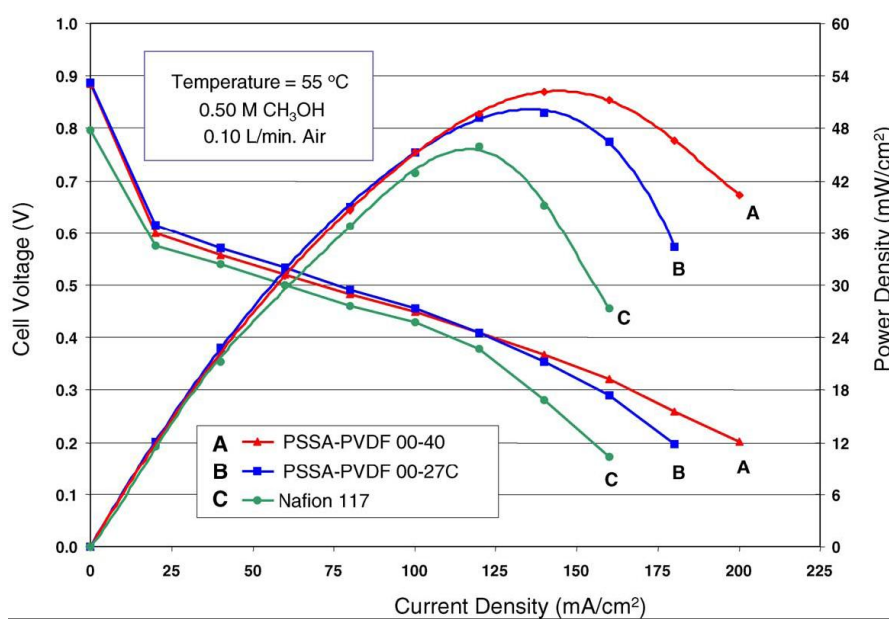

Figure 8: Polarization curve of PVDF/PSSA membrane achieved from semi interpenetrated polymer network (reproduced with permission from Elsevier; Prakash, G.K.S. *et al.*; *J. Fluorine Chem.* **2004**, *125*, 1217⁹⁸).

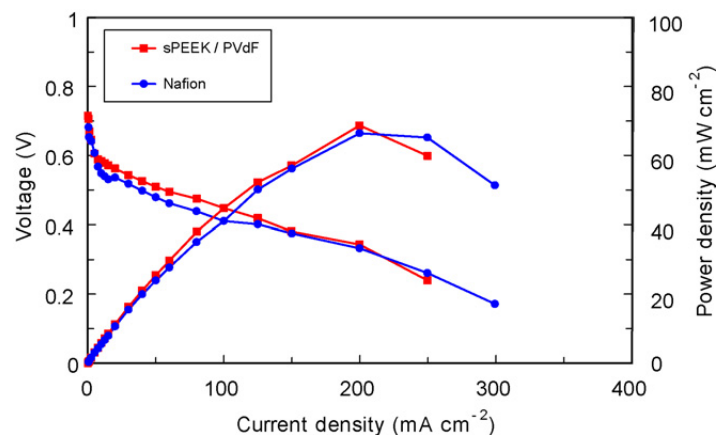

Figure 9: Electrochemical performance of a membrane composed of sulfonated PEEK (97.5 wt. %) / PVDF (2.5 wt. %) (full squares) compared to those of Nafion® (full circles); the temperature is not given; (reproduced with permission from Elsevier; Jung, H.J.; Park, J.K.; *Electrochim. Acta*, **2007**, 52, 7464).

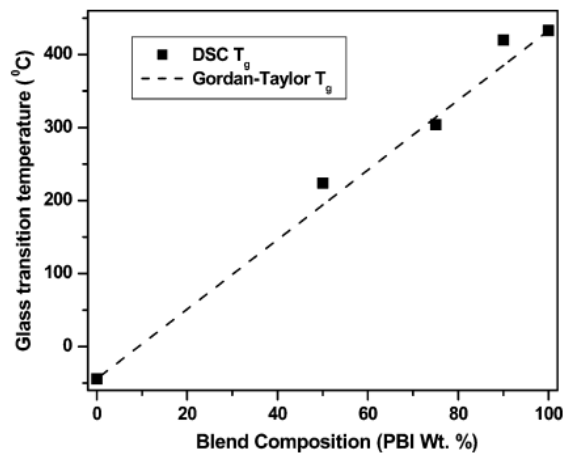

Figure 10: Variation of the glass transition temperature (T_g) of PBI as a function of PBI/PVDF blend composition. The solid points are the experimentally obtained T_g values from the DSC study, and the dotted line is the calculated T_g curve according to the Gordon-Taylor equation with $k=1$ (reproduced with permission from the Amer. Chem. Soc.; Arunbabu, D. ; Sannigrahi, A.; Jana, T; *J. Phys. Chem. B* **2008**, *112*, 5305).

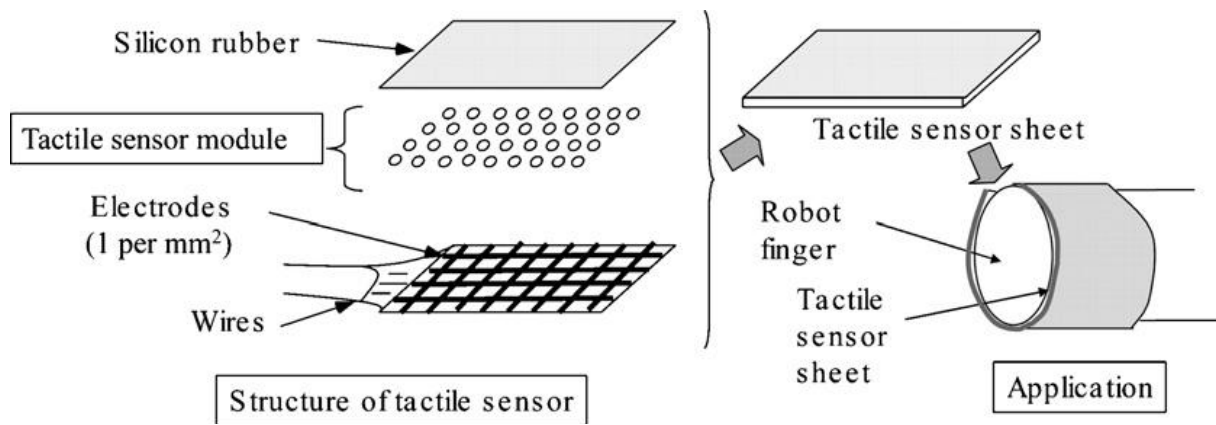

Figure 11: Tactile sensor for robotic applications (reproduced with permission from K. Takashima *et al.*, *Sensors and Actuators*, **2008**, A 144, 90).

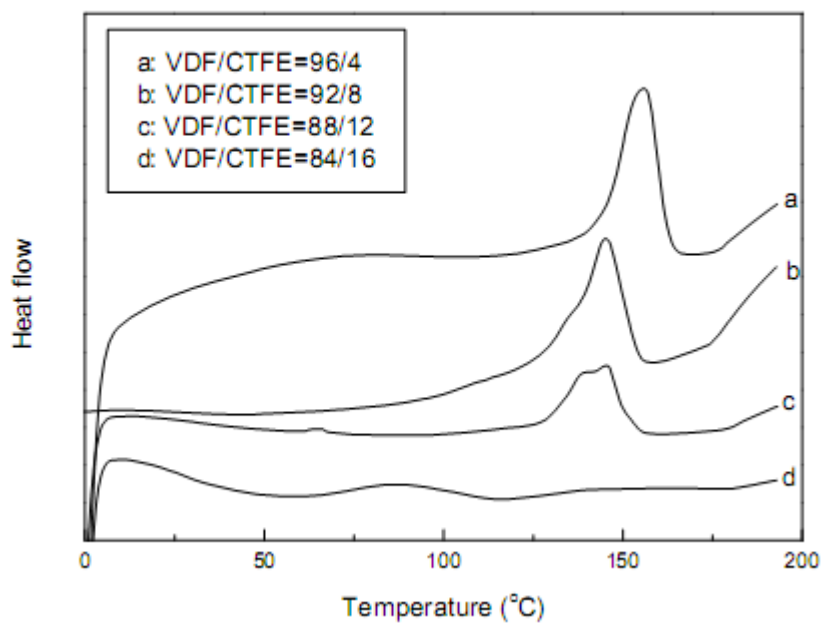

Figure 12: Differential scanning calorimetry thermograms of poly(VDF-co-CTFE) copolymers containing various amounts of CTFE (reproduced with permission from Chung, M.; Zhang, Z.; Chalkova, E.; Wang, C.; Fedkin, M.; Sharma, S.; Lvov, S.; *Electr. Chem. Soc. Trans.*, **2007**, *11*, 35; proceedings of the 212th Meeting of the Electr. Chem. Soc., Washington (USA), Oct. 7-12, **2007**).

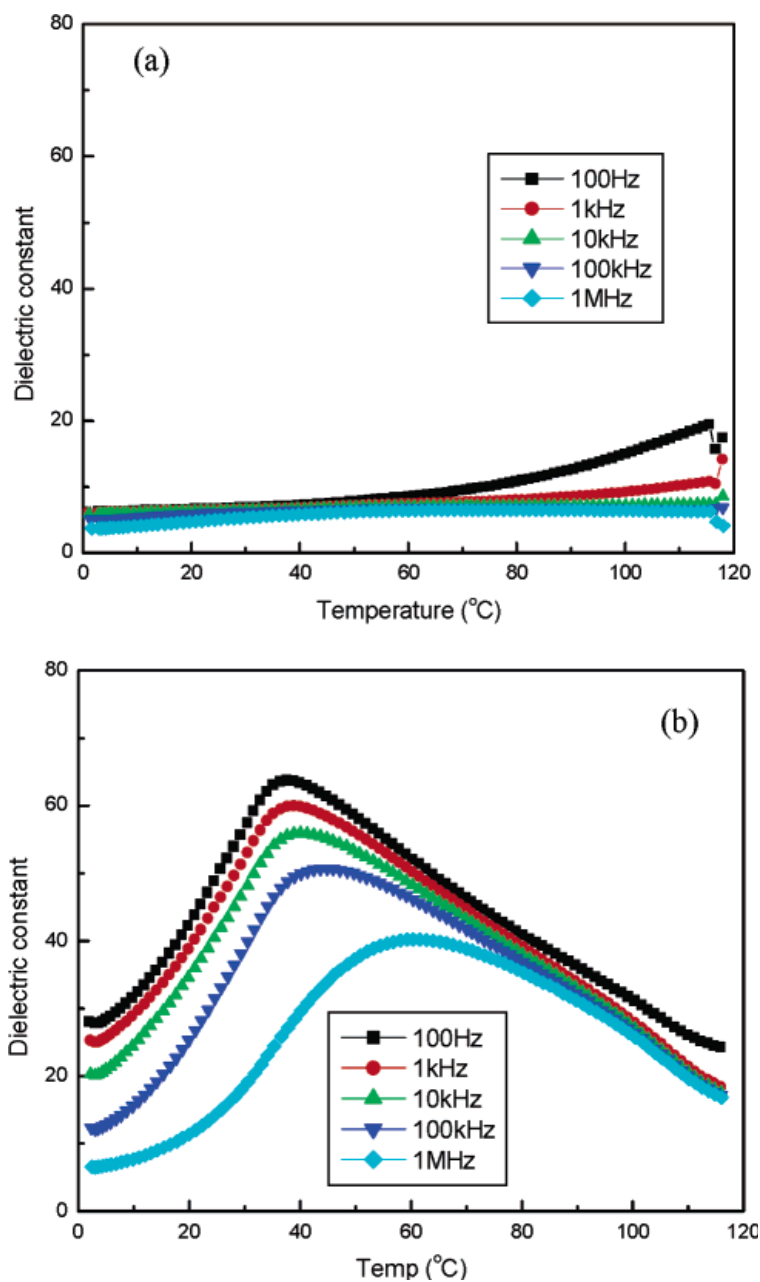

Figure 13: Dielectric constant of (a) poly(VDF-co-CTFE) (92/8 mol %) copolymer (melting temperature, $T_m = 145.0$ °C; Curie temperature, $T_c =$ non-assessed) and (b) poly(VDF-ter-TrFE-ter-CTFE) (65.6/26.7/7.7 mol %) terpolymer ($T_m = 123.6$ °C and $T_c = 23.8$ °C) (reproduced with permission from the *Amer. Chem. Soc.* Zhang, Z.; Mike Chung T.C.; *Macromolecules*, **2007**, *40*, 783¹²⁸).

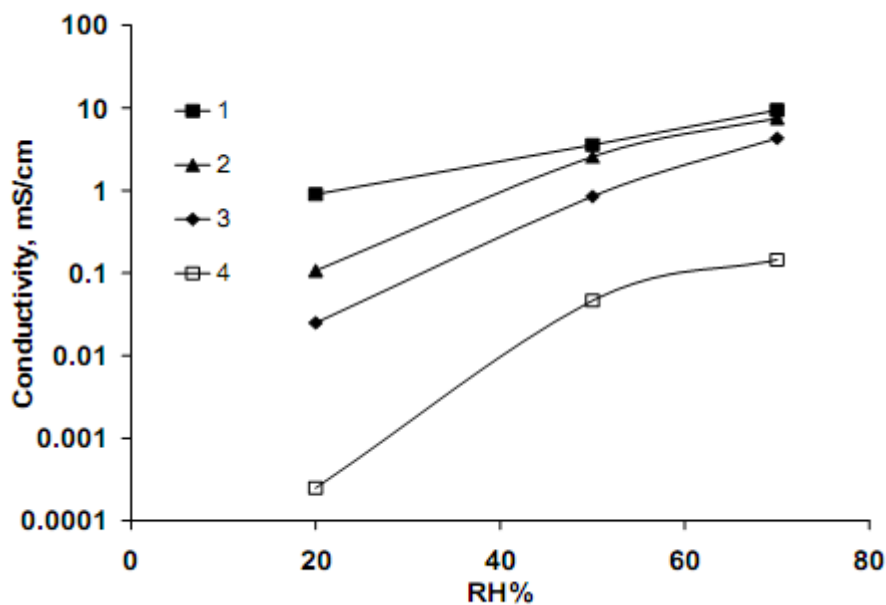

Figure 14: Conductivity of new composite materials compared to Nafion[®] at 120 °C and different relative humidity (RH) (1 - Nafion[®] 115; 2 – 40 % poly(VDF-co-CTFE) copolymer / 60% sulfonated silicon dioxide; 3 - poly(VDF-co-CTFE)-g-SPETMS (reproduced with permission from Chung, M.; Zhang, Z.; Chalkova, E.; Wang, C.; Fedkin, M.; Sharma, S.; Lvov, S.; *Electr. Chem. Soc. Trans.*, **2007**, *11*, 35; proceedings of the 212th Meeting of the Electr. Chem. Soc., Washington (USA), Oct. 7-12, **2007**¹³⁸).

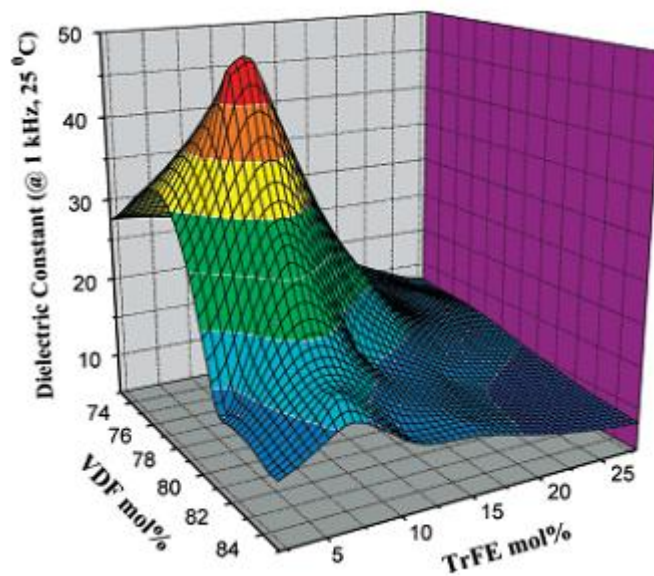

Figure 15: A three-dimensional plot of room temperature dielectric constants at 1 kHz for the P(VDF-CTFE-TrFE) terpolymers (reproduced with permission from the Amer. Chem. Soc. Lu, Y.; Claude, J.; Neese, B.; Zhang, Q.M.; Wang, Q.; *J. Amer. Chem. Soc.*, **2006**, *128*, 8120^{126a}).

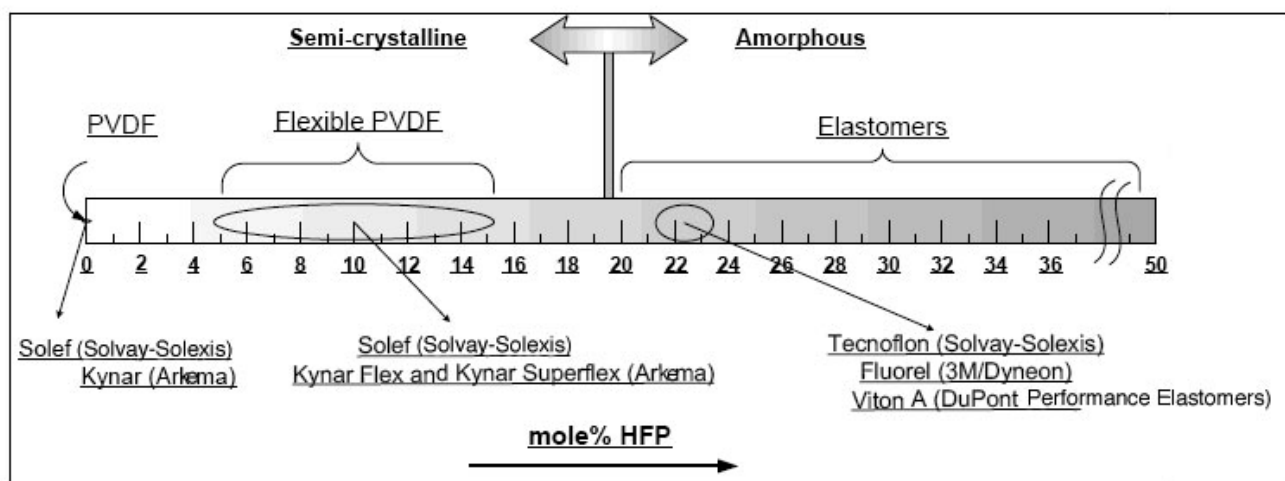

Figure 16: Semi-crystalline or amorphous poly(VDF-co-HFP) copolymers according to the content of HFP in the copolymer (reproduced with permission from *Amer. Chem. Soc.*, Ahmed *et al.*, *Macromolecules*, **2007**, *40*, 9322¹⁵⁶)

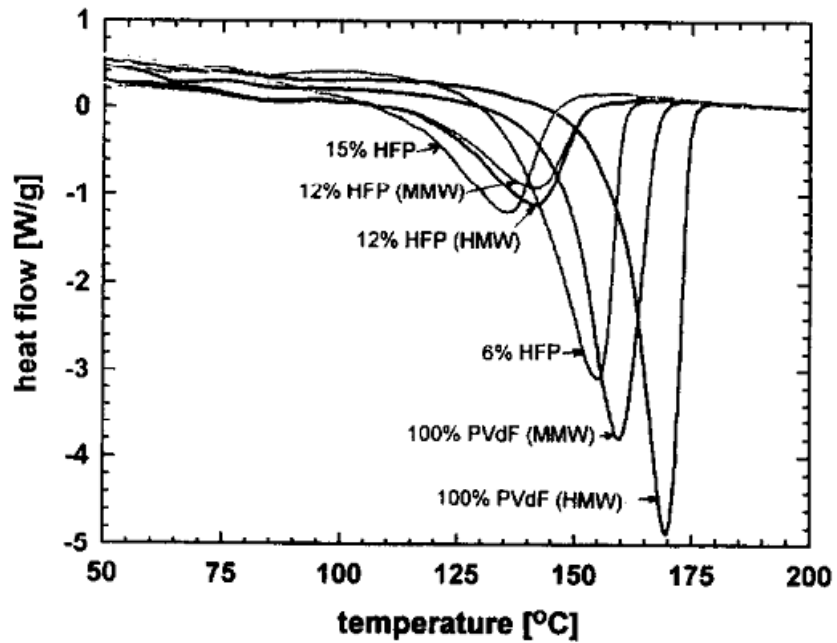

Figure 17: Differential scanning calorimetry thermograms of poly(VDF-co-HFP) copolymers with different HFP contents (HMW and MMW stand for high molecular weight and medium molecular weights, respectively; reproduced with permission from Essevler, J.M. Tarascon *et al.*, *Solid State Ionic*, **1996**, 86-88, 49¹⁶¹)

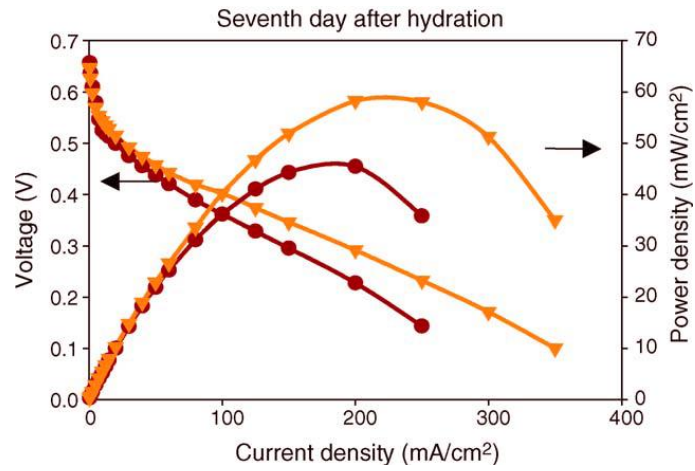

Figure 18: Polarization curves of: coated Nafion[®] (orange) and virgin Nafion[®] 117 (brown) at 30 °C (reproduced with permission from Elsevier; Cho et al.; *J. Power Sources*, **2006**, 159, 524).

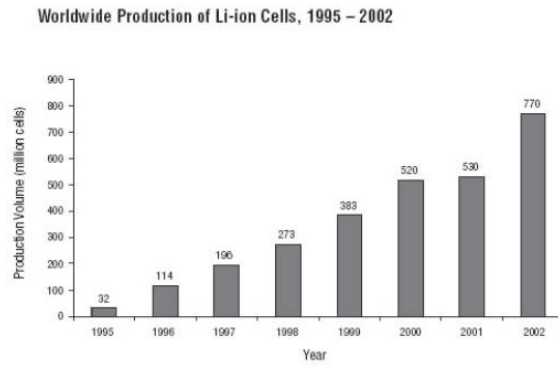

Figure 19: Evolution of Lithium ion cells *versus* years

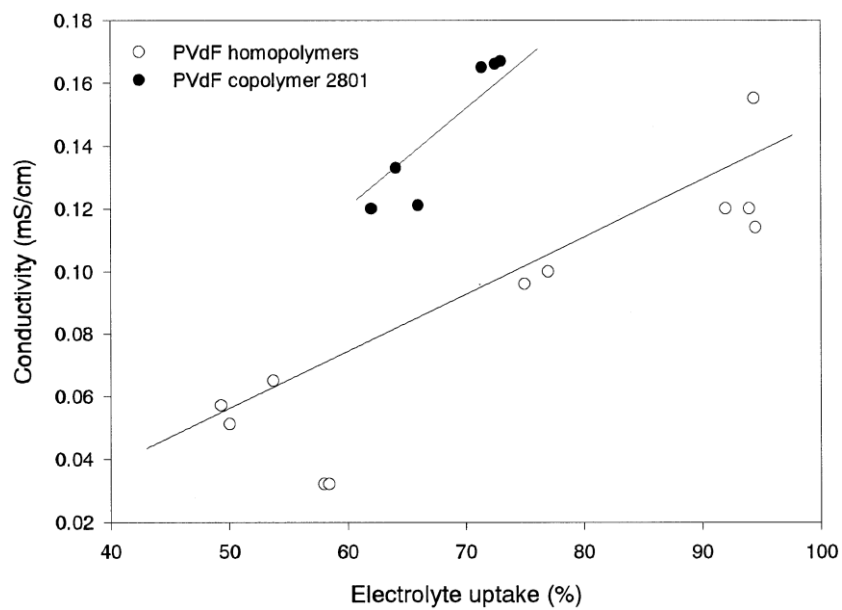

Figure 20: Conductivity as a function of the electrolyte uptake for low-porous PVDF and poly(VDF-co-HFP) copolymers (PVDF copolymer 2801) membranes (reproduced with permission from Elsevier; Michot, T.; Nishimoto, A.; Watanabe, M.; *Electrochim. Acta*, **2000**, *45*, 1347^{170b}).

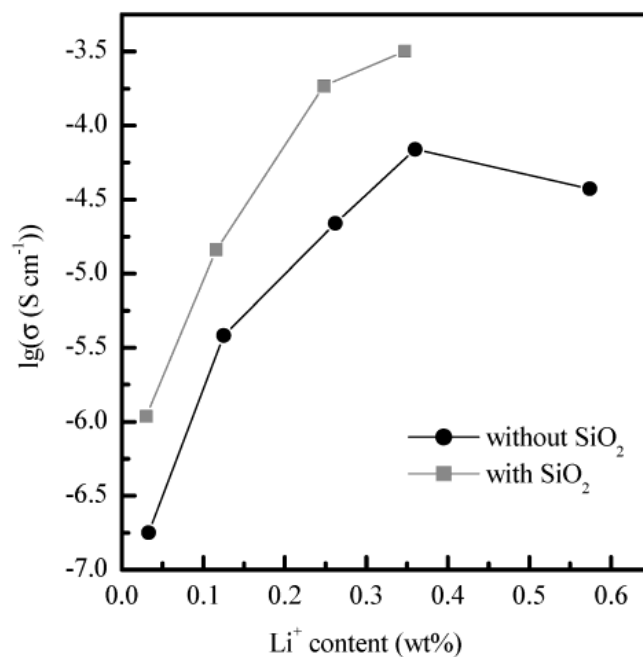

Figure 21: The Li^+ content of gel polymer electrolyte without SiO_2 (-O-) and with SiO_2 (-square-) dependence on the ionic conductivity (reproduced with permission from the *Amer. Chem. Soc.* (Wang et al. *J. Phys. Chem. B* **2004**, *108*, 1365¹⁸²)).

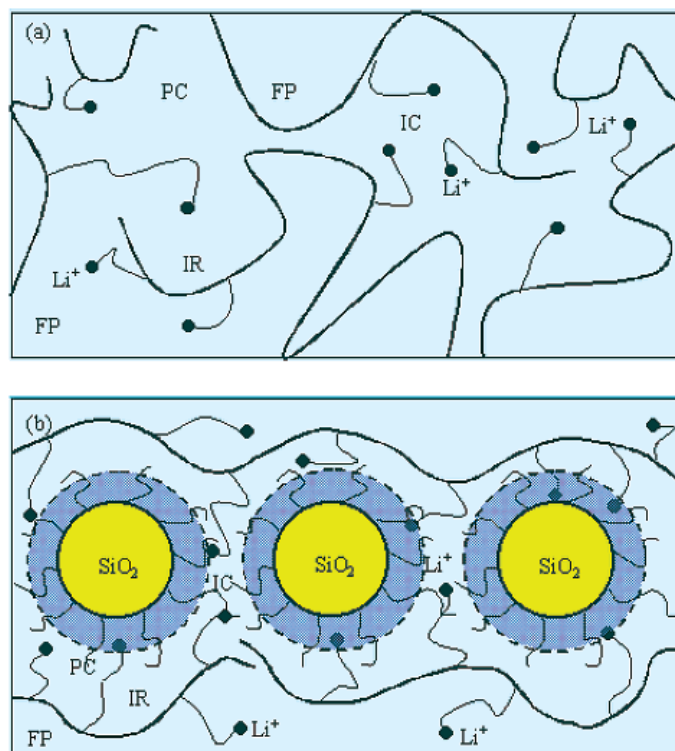

Figure 22: The two models proposed for the interaction between polymer and polycarbonate in the Nafion-Li/PVDF-HFP blend polymer electrolyte membrane (a) without SiO₂ and (b) with SiO₂. The fluorocarbon phase (FP), interfacial region (IR), and ionic clusters (IC) are shown in it (reproduced with permission from the *Amer. Chem. Soc.* (Wang et al. *J. Phys. Chem. B* **2004**, *108*, 1365¹⁸²).

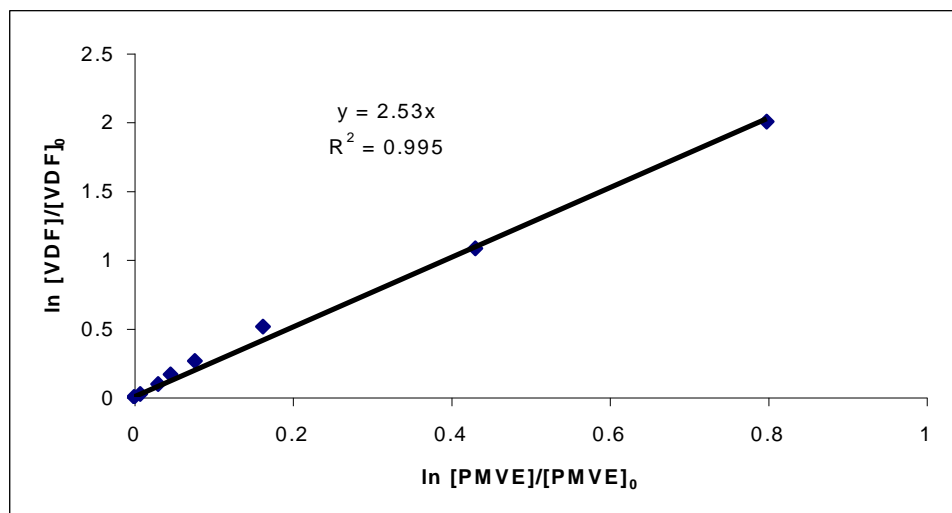

Figure 23: Evolution of $\ln[VDF]/[VDF]_0$ versus $\ln[PMVE]/[PMVE]_0$ for the radical copolymerization of VDF and PMVE in emulsion in the presence of IC_4F_8I . Feed composition in VDF and PMVE (mol-%) 90/10 in aqueous medium.

FIGURE 24

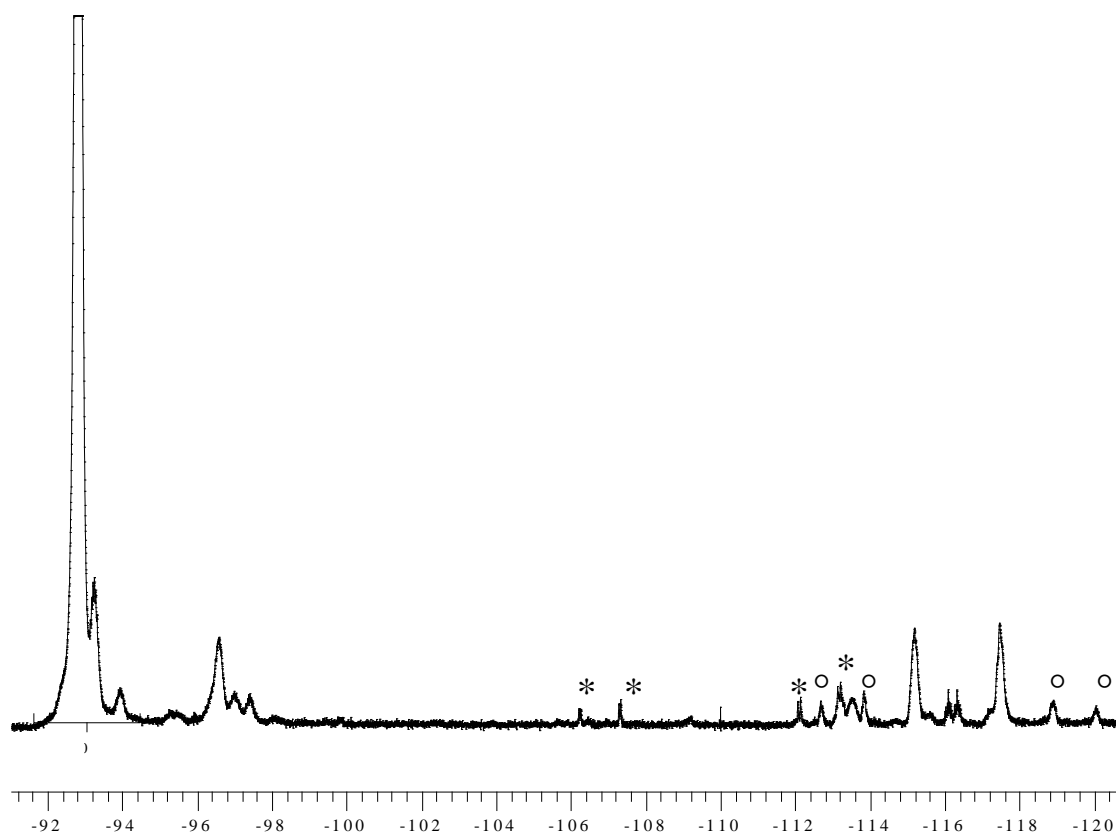

Figure 24: ^{19}F -NMR spectrum of the poly(VDF-co-methyl β,β -difluoroacrylate) copolymer (90 mol. % VDF in the feed; 86 mol. % VDF in copolymer); symbols ° and * represent the AB and A'B' systems, respectively. An unexpected slight high field shift of 2 ppm is noted.

Figure 25: Monomer-polymer copolymerization curves from the radical copolymerization of VDF with various comonomers (the full lines represent the theoretical curves)

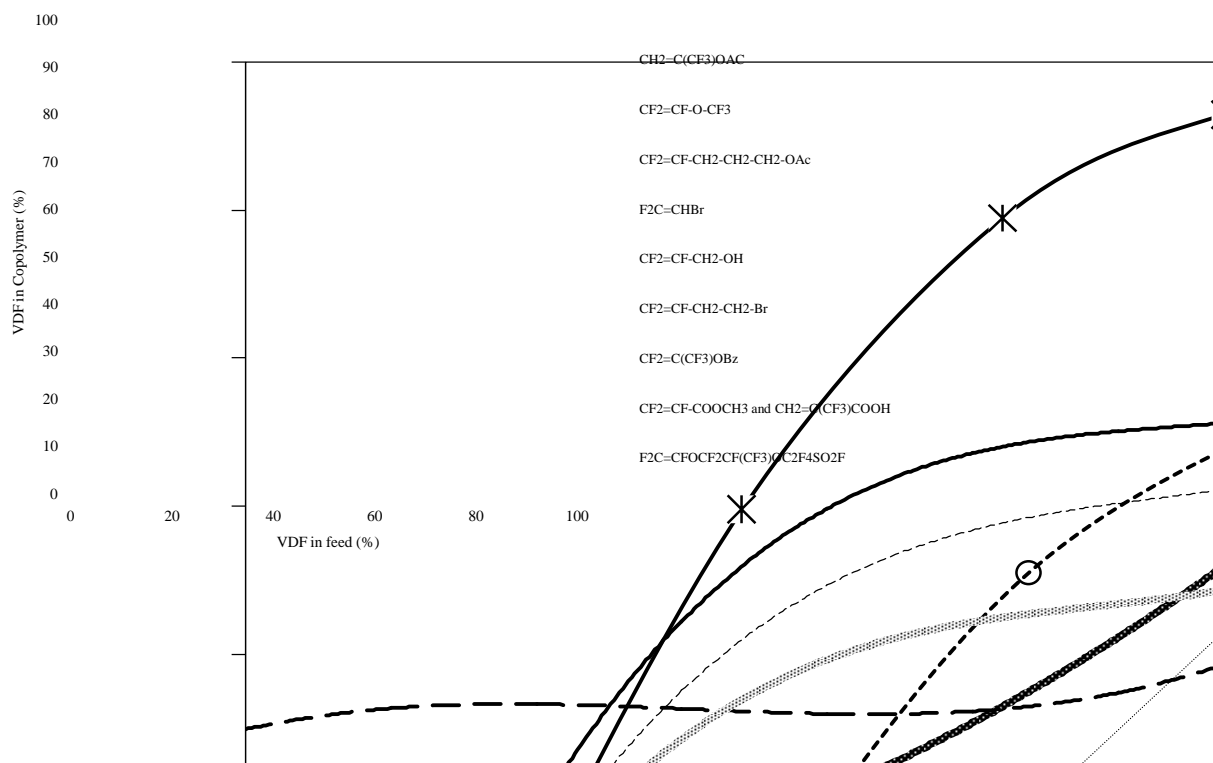

FIGURE 26

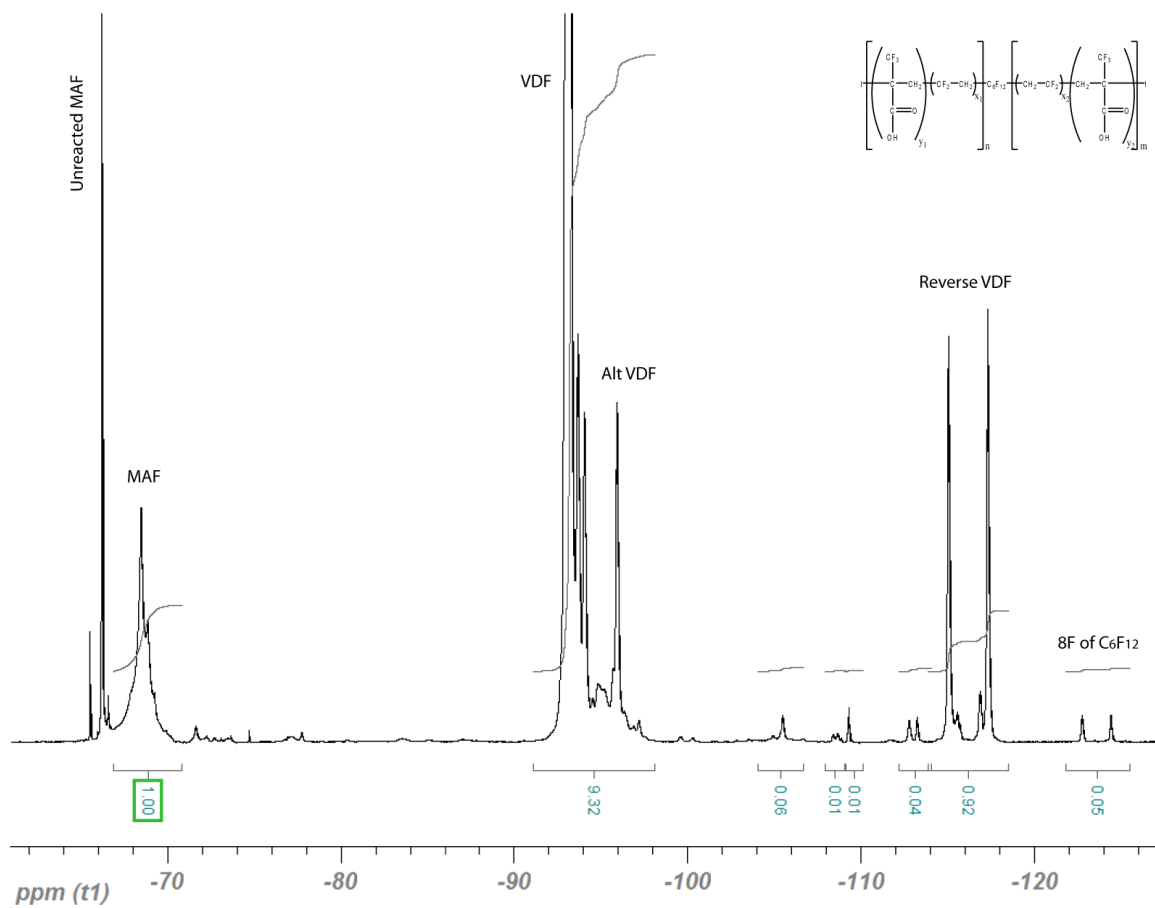

Figure 26: ^{19}F NMR spectrum of poly(VDF-co-MAF) copolymer recorded in DMSO (1024 scans, $D1=2\text{s}$); feed mol. % VDF/ α -trifluoromethacrylic acid (MAF) = 90/10; in copolymer mol.% 94/6; $\text{MW}= 60,000 \text{ g}\cdot\text{mol}^{-1}$. $\text{IC}_6\text{F}_{12}\text{I}$ was used as chain transfer agent.

FIGURE 27

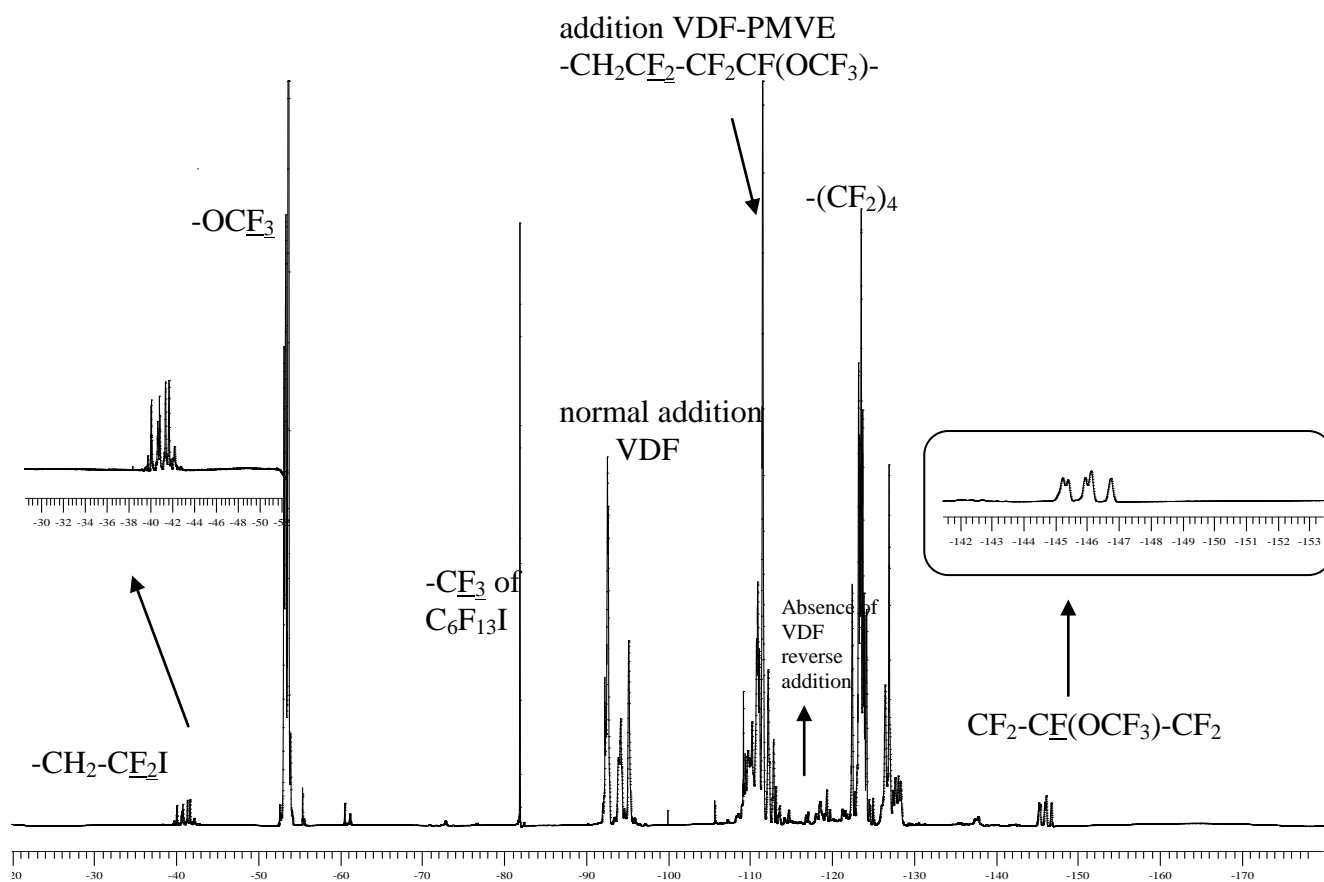

Figure 27: ^{19}F NMR spectrum of poly(VDF-co-PMVE) copolymer (recorded in d^6 acetone) obtained by Iodine transfer copolymerization of VDF and PMVE in the presence of $\text{C}_6\text{F}_{13}\text{I}$ as the chain transfer agent (feed 50/50 in VDF/PMVE mol/mol, and 60/40 in copolymer).

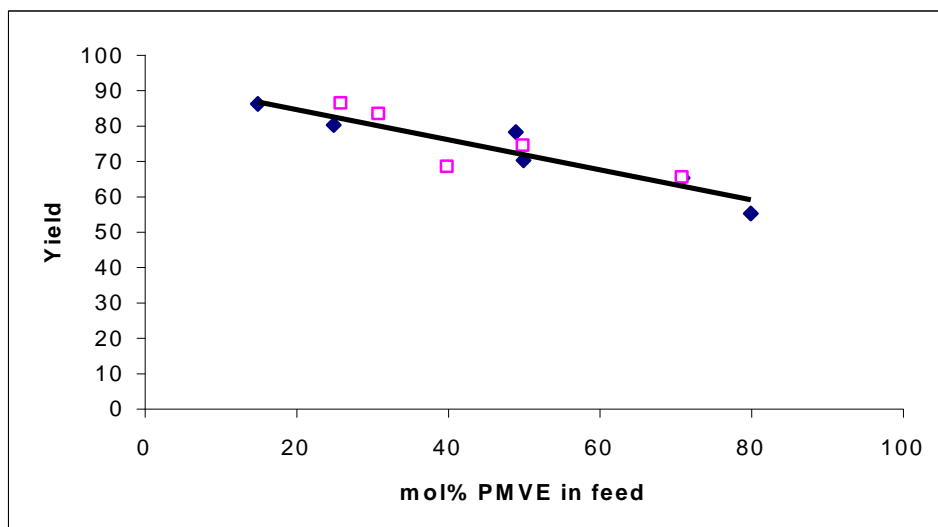

Figure 28: Evolution of yield of iodine transfer copolymerization of VDF and PMVE in the presence of C₆F₁₃I (□) or IC₄F₈I (◆) *versus* mol% PMVE in feed.

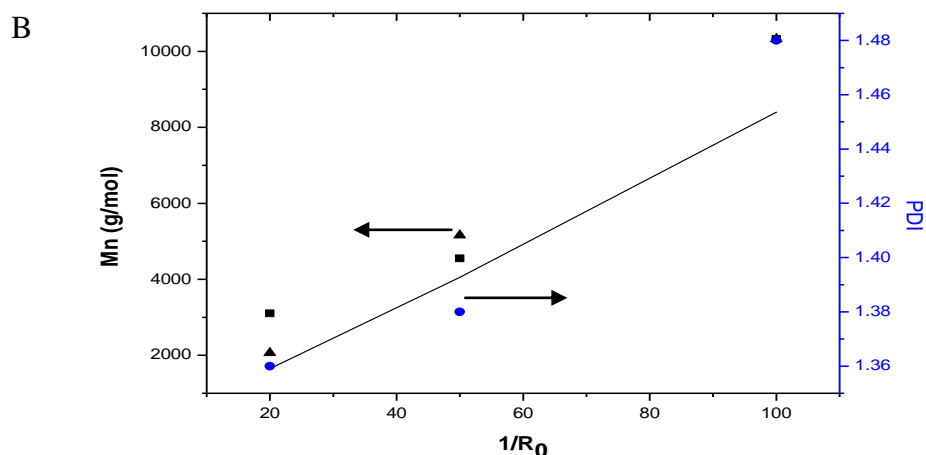
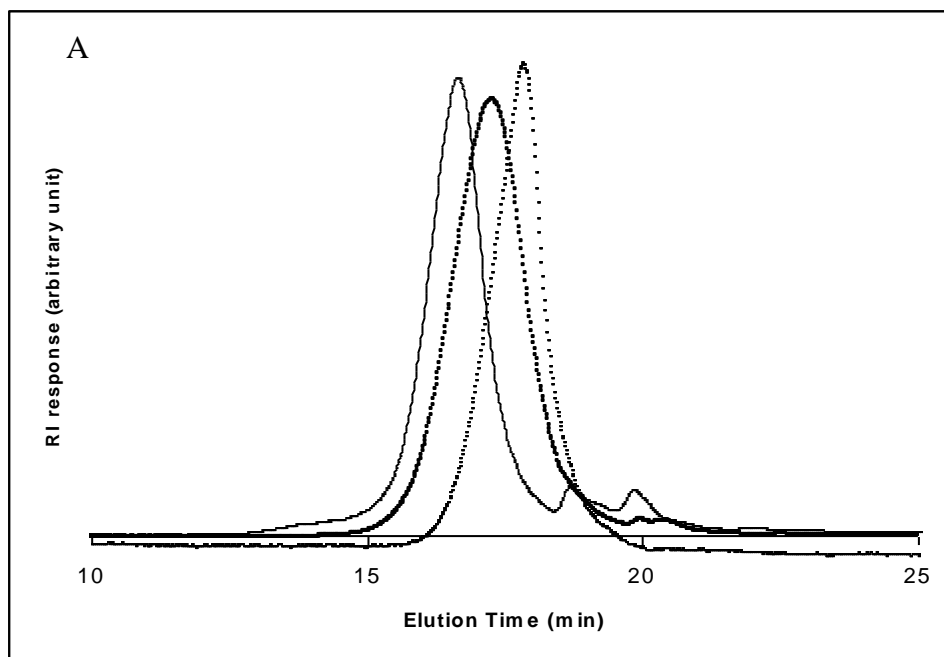

Figure 29: (A) SEC chromatograms of poly(VDF-*ter*-HFP-*ter*-F₂C=CFSF₅) terpolymers obtained by iodine transfer terpolymerization of VDF, HFP and F₂C=CFSF₅: (xx) ($[C_6F_{13}I]_0/([VDF]_0+[HFP]_0+[F_2C=CFSF_5]_0) = R_0 = 0.05$); (■) $R_0 = 0.01$; (full line) ($R_0 = 0.005$), respectively. (B) Evolution of molecular weight (M_n , ■ and ▲ assessed by SEC and ¹⁹F NMR, respectively) and polydispersity index (PDI, ●) versus $1/R_0$ ($R_0 = [C_6F_{13}I]/[M]$ where M represent the monomer concentrations. Experimental conditions: $[Initiator]_0 / [VDF+HFP+SF_5 \text{ monomer}]_0 = 0.01$ in the 1,1,1,3,3-pentafluorobutane at 75 °C for 6 hrs. The straight full line represents the theoretical curve (reproduced with permission of the American Chemical Society; Boyer *et al. Macromolecules*, **2008**, *41*, 1254¹⁹⁷).

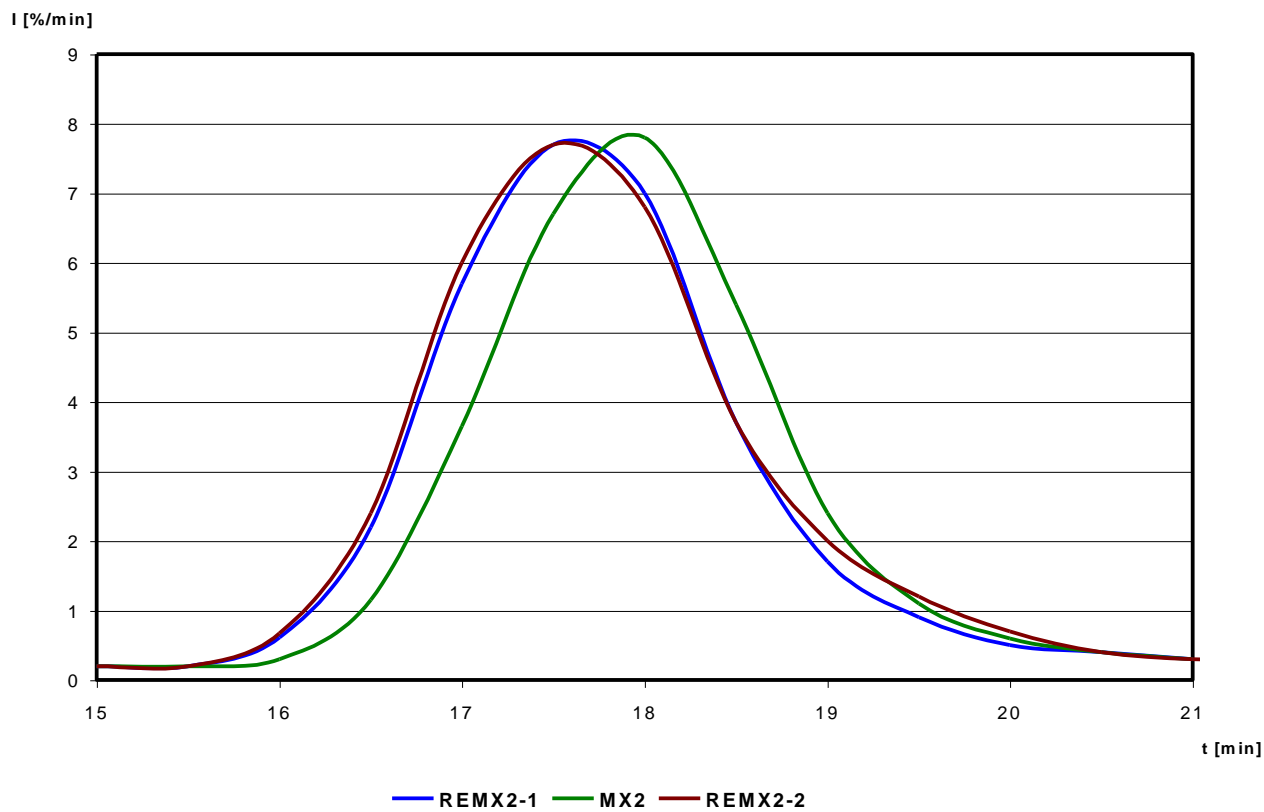

Figure 30: Superposition of SEC chromatograms of poly(VDF-co-HFP) copolymer (70/30 in feed) in the presence of MX2 fluorinated xanthate; reaction time $t = 7\text{h}$, VDF (REMX2-1) and VDF/HFP (70/30 in feed) (REMX2-2); MX2 stands for $\text{C}_6\text{F}_{13}\text{C}_2\text{H}_4\text{C}(\text{O})\text{CH}(\text{CH}_3)\text{-poly}[(\text{VDF})\text{-co-}(\text{HFP})]\text{-SC}(\text{S})\text{OCH}_2\text{CH}_3$ ³¹⁷.

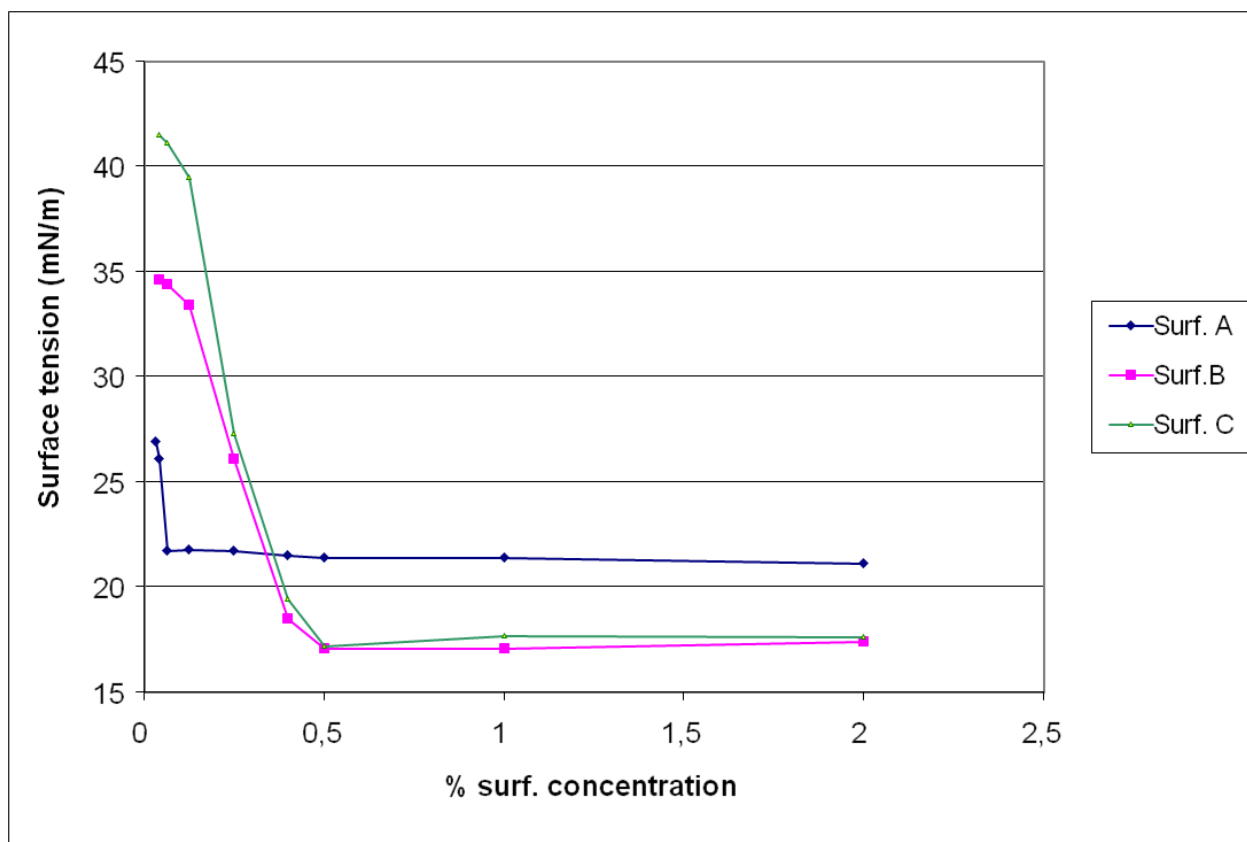

Figure 31: Surface tension of aqueous solutions of synthesized fluorinated surfactants: Surf. A- $(CF_3)_2CF-CH_2-CH(CF_3)(CH_2)_3SCH_2CO_2(CH_2CH_2O)_{13}CH_3$; Surf. B- $(CF_3)_2CF(TFP)CH_2CH_2N^+C_5H_5, I^-$; Surf. C- $(CF_3)_2CF(VDF)_2(TFP)_3[CH_2CH(OH)]_5H$.

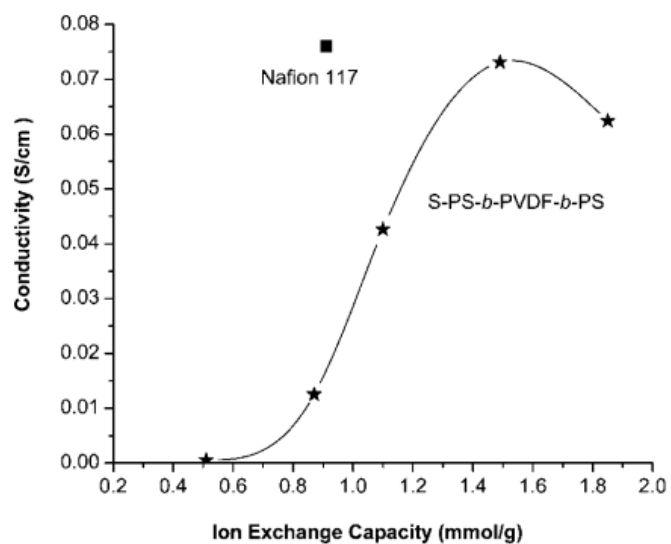

Figure 32: Conductivities of Nafion® 117 and of membranes achieved from PSSA-b-PVDF-b-PSSA triblock copolymer as a function of the ion-exchange capacity (reproduced with permission from the Amer. Chem. Soc, *Chem. Mater.*, **2007**, *19*, 5937; Xu *et al.*³³⁶)

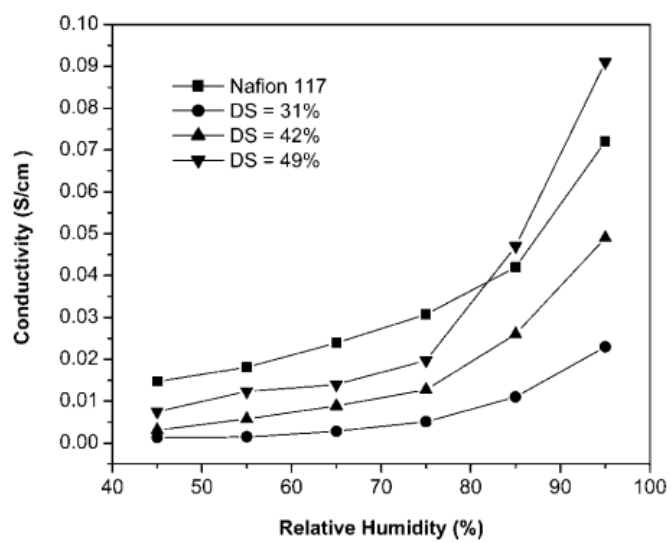

Figure 33: Proton conductivity *versus* the relative humidity of PSSA-*b*-PVDF-*b*-PSSA triblock copolymers and Nafion® 117 membranes; DS stands for degree of sulfonation (reproduced with permission from the Amer. Chem. Soc, Xu *et al.*; *Chem. Mater.*, **2007**, *19*, 5937³³⁶).

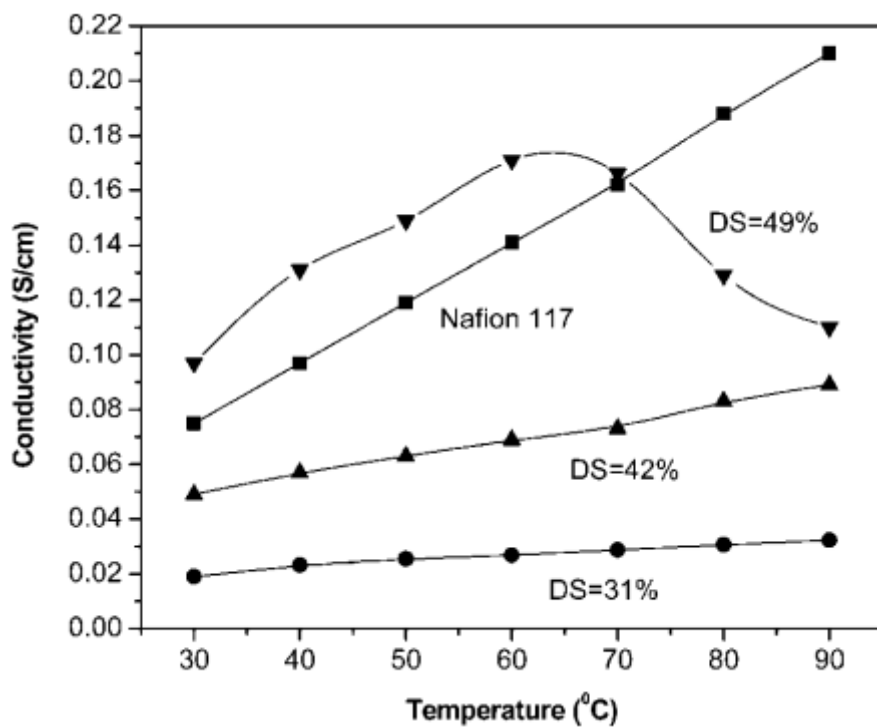

Figure 34: Variation of proton conductivity measured under 95 % relative humidity *versus* temperature for PSSA-*b*-PVDF-*b*-PSSA triblock copolymers and Nafion®117 membranes (reproduced with permission from the Amer. Chem. Soc, Xu *et al.*; *Chem. Mater.*, **2007**, *19*, 5937³³⁶).

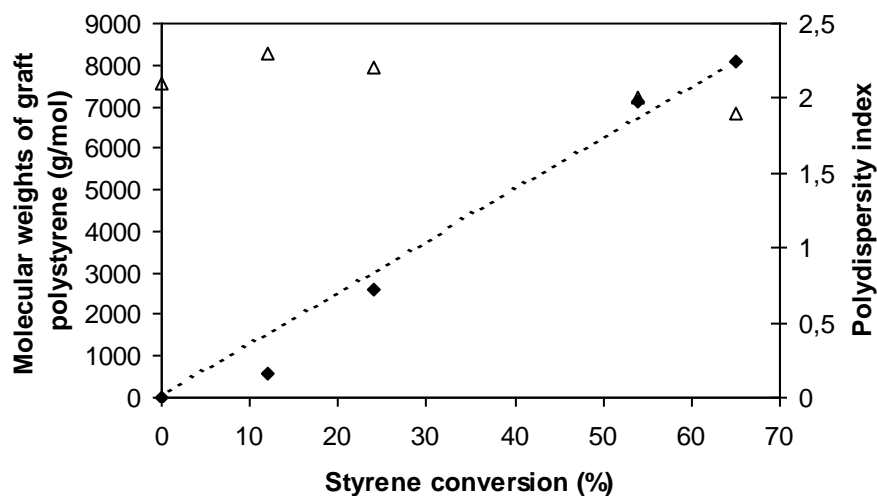
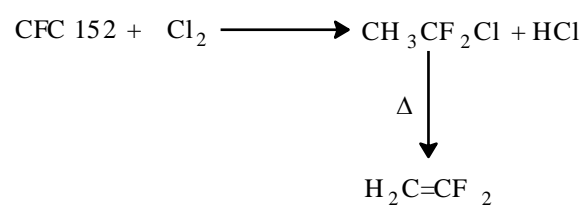

Figure 35: Dependence of molecular weight (\blacklozenge) and polydispersity index (Δ) of PVDF-g-PS copolymer versus styrene conversion for the ATRP of styrene using poly(VDF-co-BDFO) copolymers as the macroinitiator. $[\text{DMF}]_0 : [\text{Styrene}]_0 : [\text{Macroinitiator}]_0 : [\text{HMTETA}]_0 : [\text{Cu}^{\text{I}}\text{Br}]_0 = 500 : 100 : 10 : 0.5 : 0.5$; $T = 90\text{ }^\circ\text{C}$.

BDFO, HMTETA and DMF stand for 8-bromo-1H,1H,2H-perfluorooct-1-ene, 1,1,4,7,10,10-hexamethyltriethylenetetramine and dimethylformamide, respectively (reproduced with permission of the American Chemical Society; Boyer, C. et al.; *Macromolecules*, **2006**, *39*, 9087³⁸³).

SCHEME 1



Scheme 2

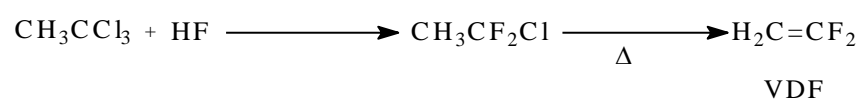

SCHEME 3

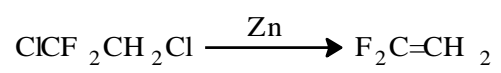

Scheme 4

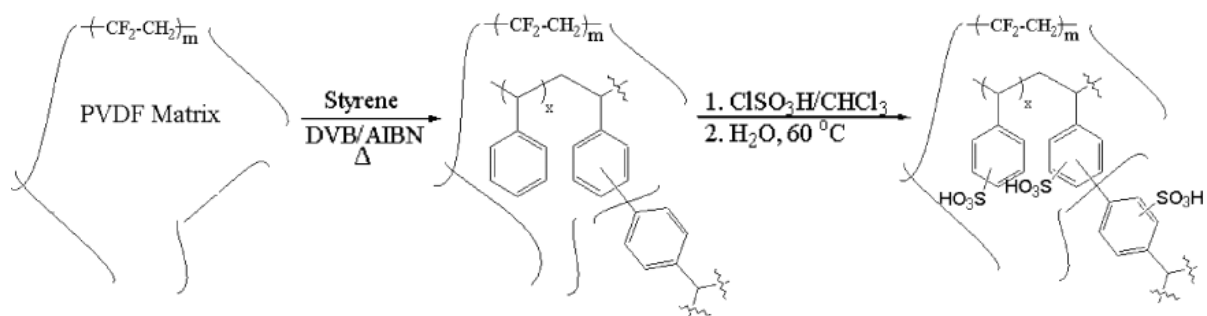

Scheme 5

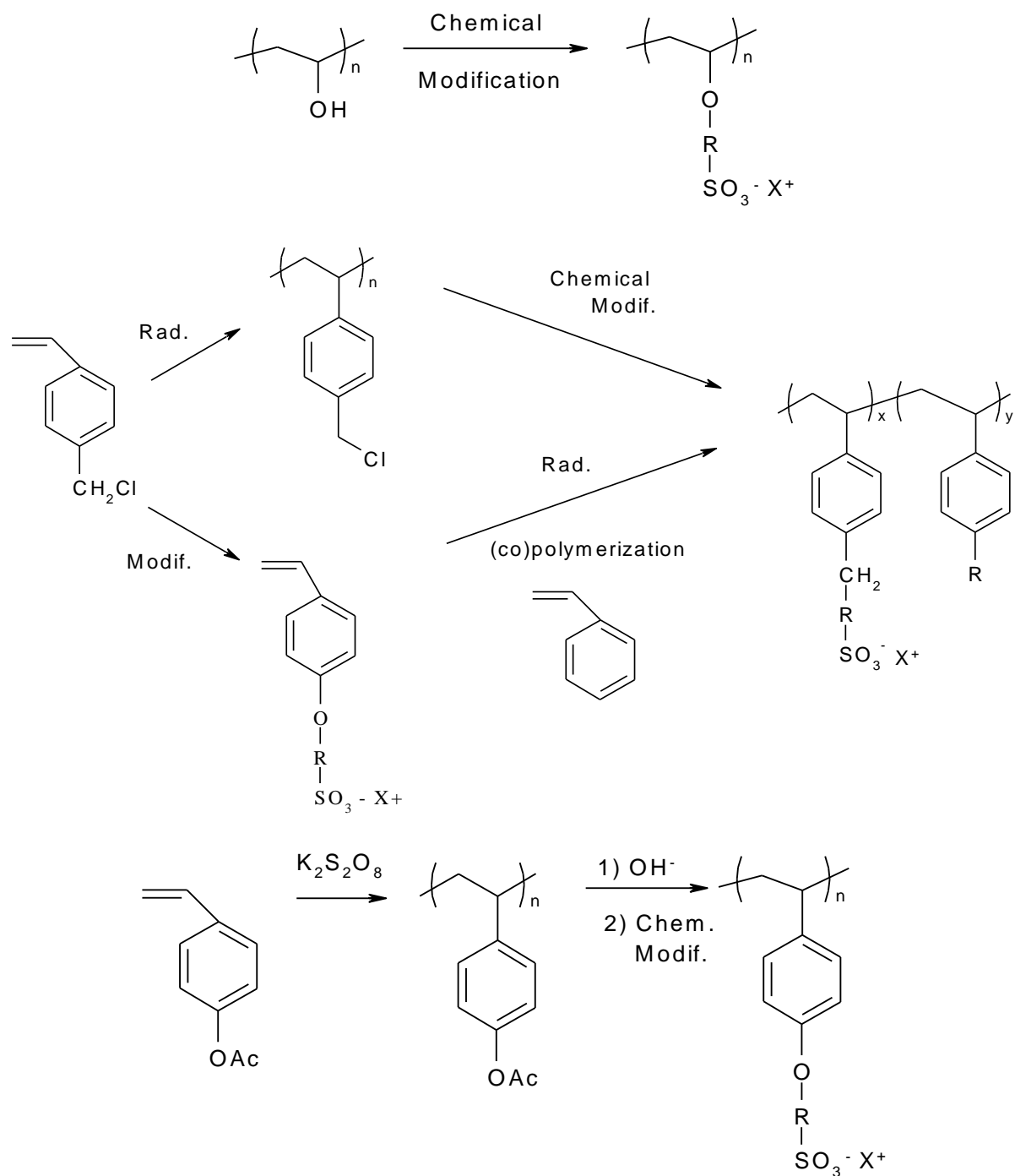

Scheme 6

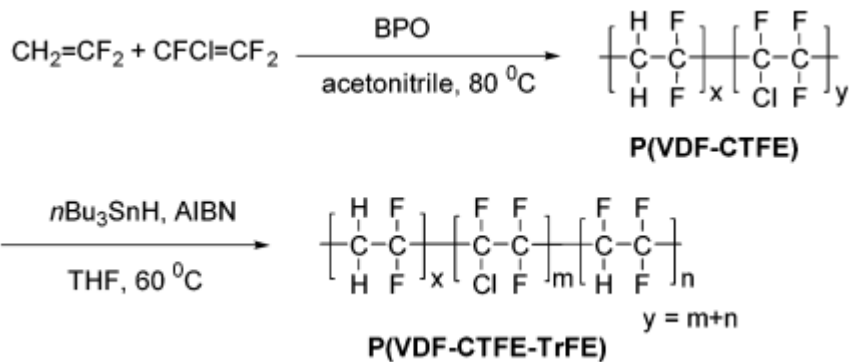

(reproduced with permission of Amer. Chem. Soc., Lu *et al.* *J. Amer. Chem. Soc.*, **2006**, *128*, 8120).

Scheme 7

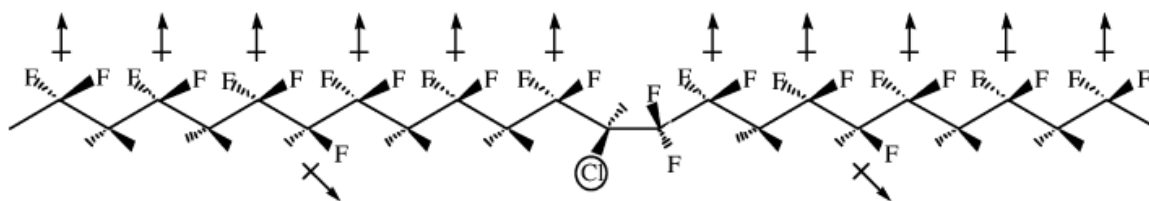

(reproduced with permission from the *Amer. Chem. Soc.* Zhang, Z.; Mike Chung T.C.; *Macromolecules*, **2007**, *40*, 783¹²⁸).

SCHEME 8

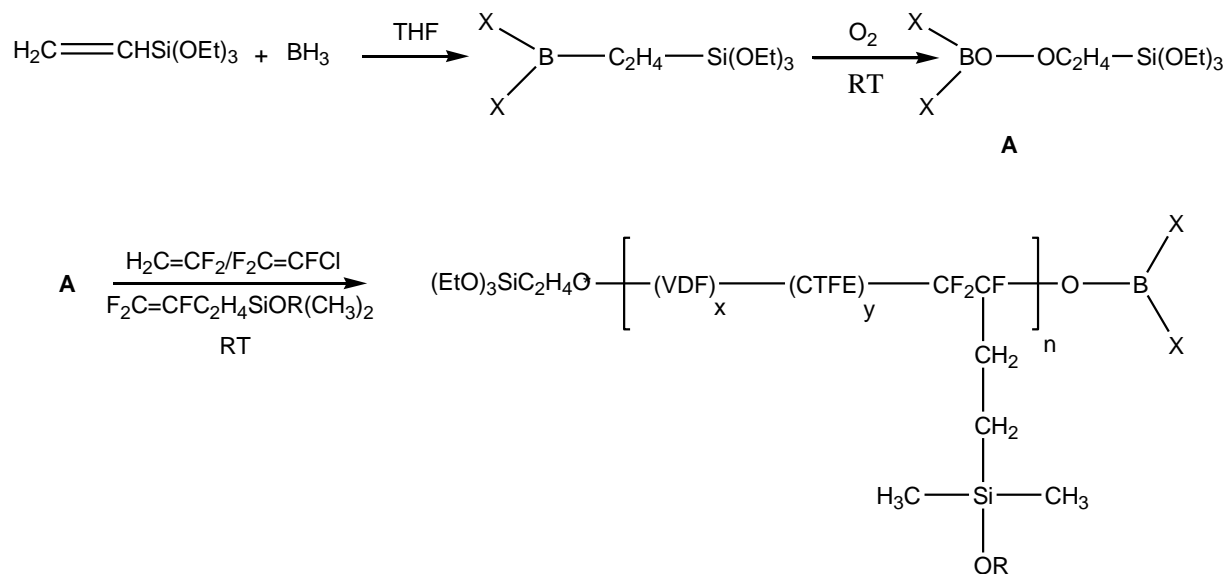

where X can be H or C₂H₄Si(OEt)₃.

SCHEME 9

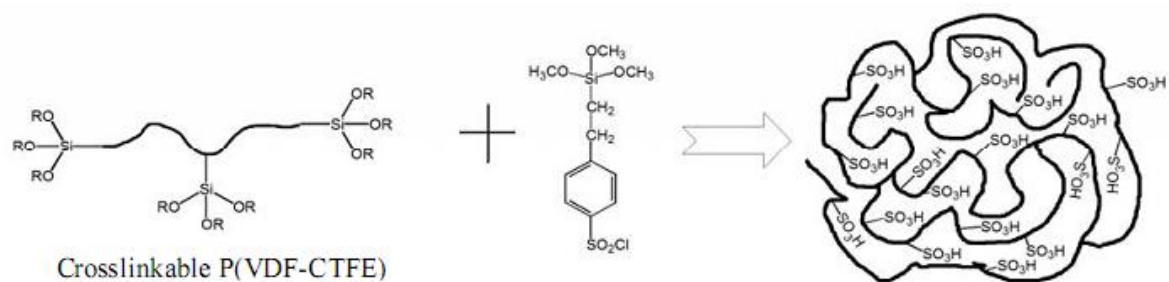

(reproduced with permission from Chung, M.; Zhang, Z.; Chalkova, E.; Wang, C.; Fedkin, M.; Sharma, S.; Lvov, S.; *Electr. Chem. Soc. Trans.*, **2007**, *11*, 35; proceedings of the 212th Meeting of the Electr. Chem. Soc., Washington (USA), Oct. 7-12, **2007**¹³⁸).

SCHEME 10

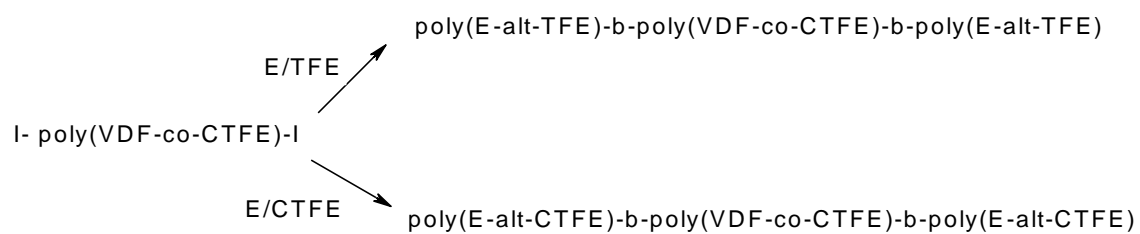
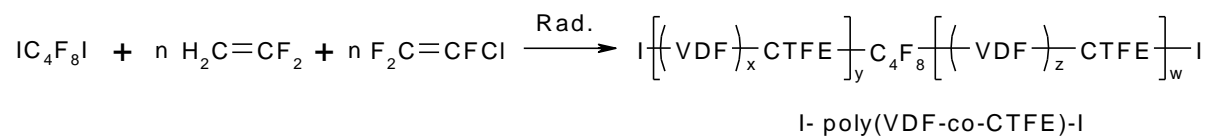

SCHEME 12

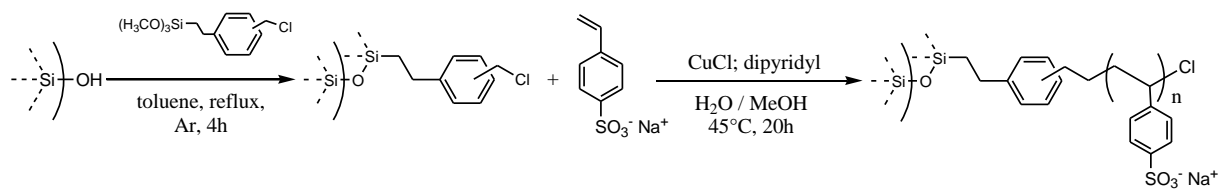

SCHEME 13

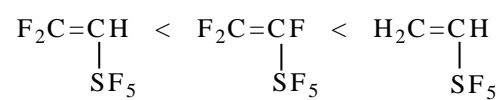
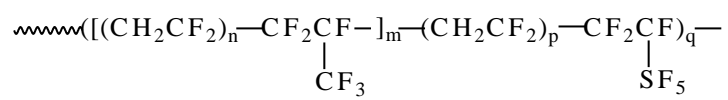

SCHEME 14

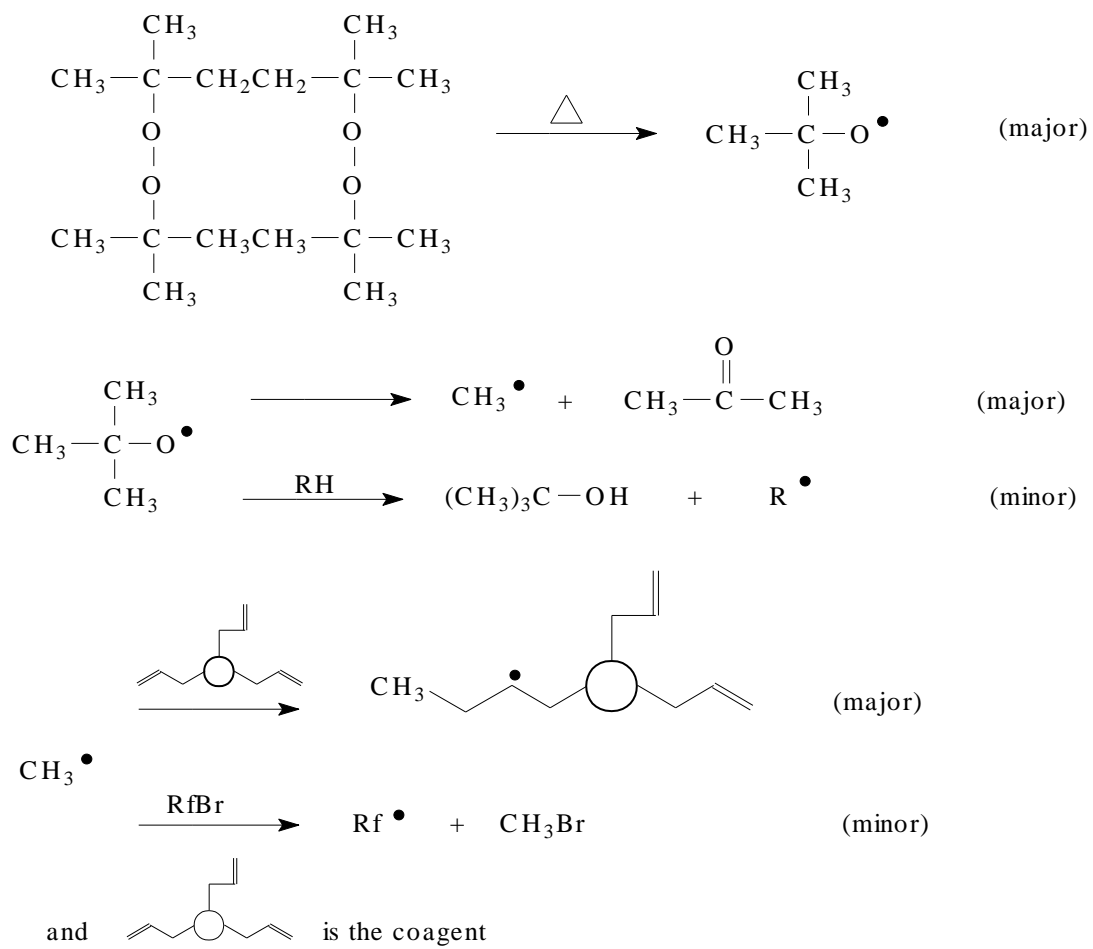

SCHEME 15

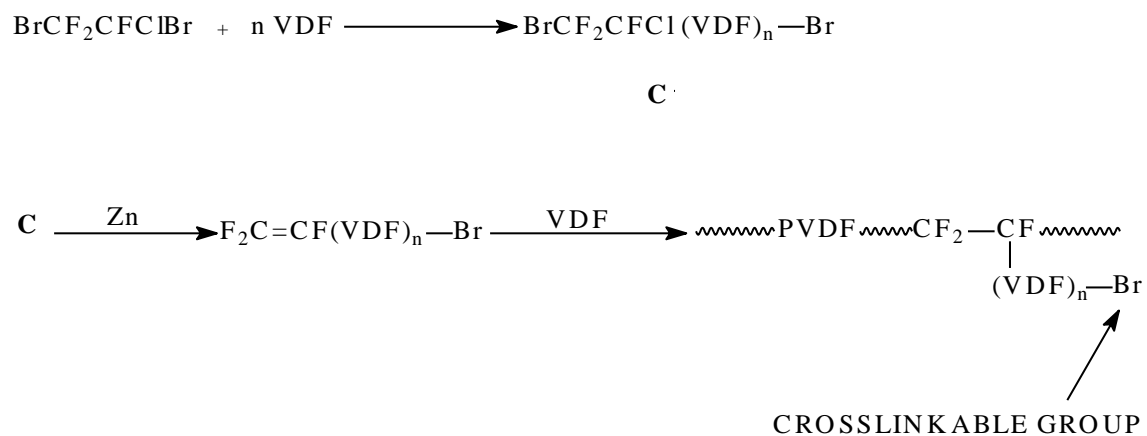

Scheme 15: synthesis of original trifluorovinyl macromonomer containing oligo(VDF) bearing a bromine side group for crosslinking.

SCHEME 16

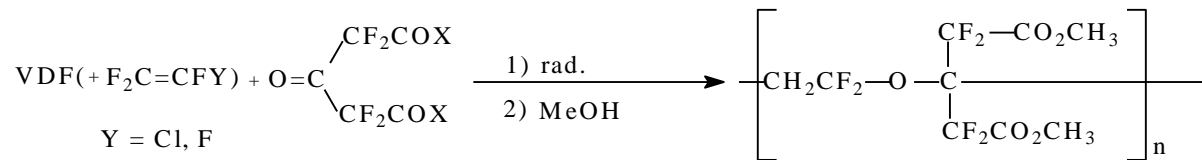

SCHEME 17

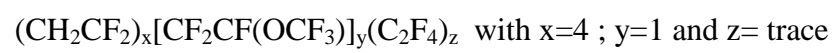

SCHEME 18

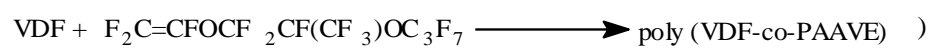

Scheme 19

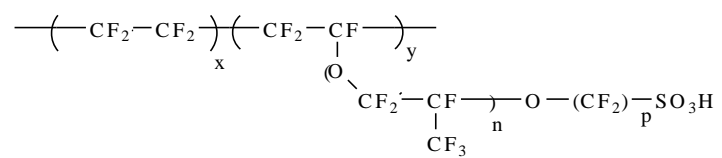

where x ranges from 5 to 14 for y=1; n can be 0, 1 or 2 and p = 2-4.

SCHEME 20

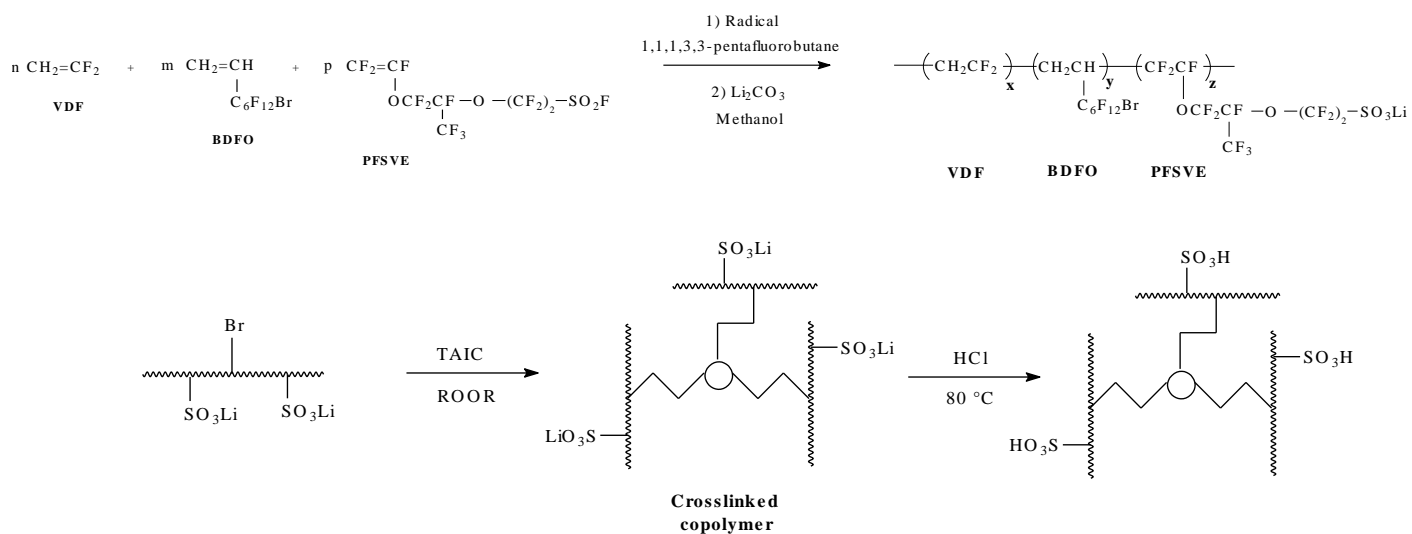

SCHEME 21

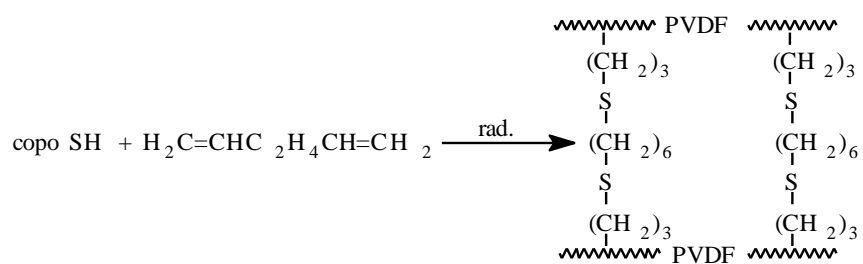
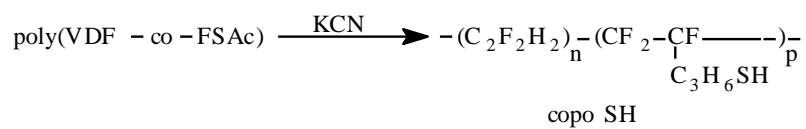
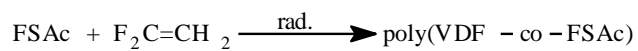
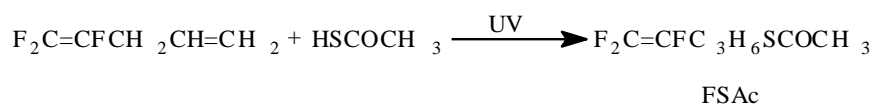

SCHEME 22

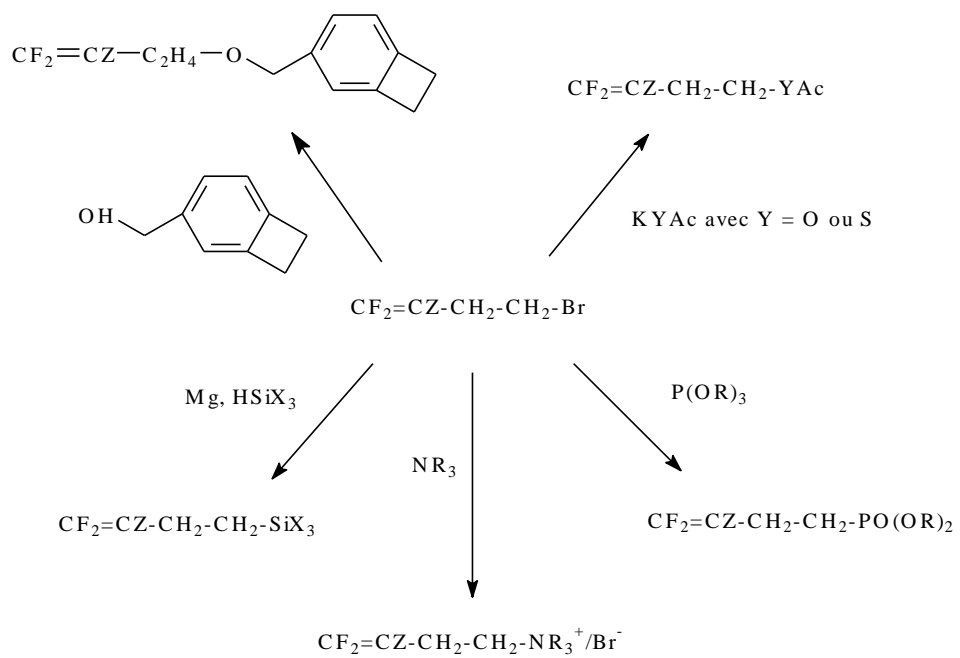

SCHEME 23

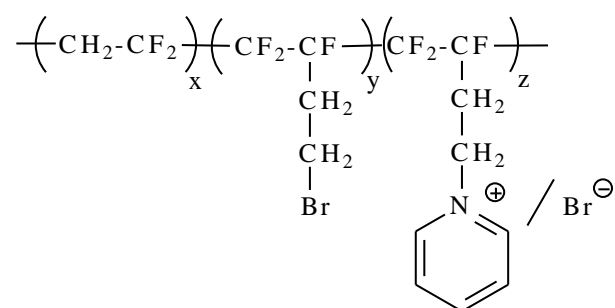

SCHEME 24

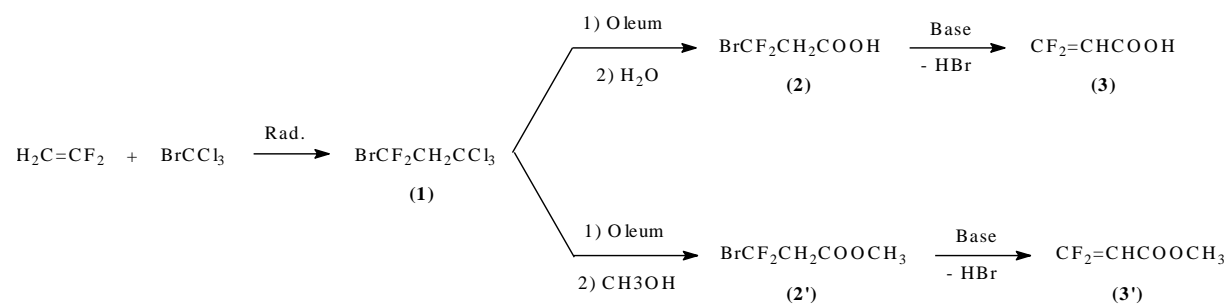

SCHEME 25

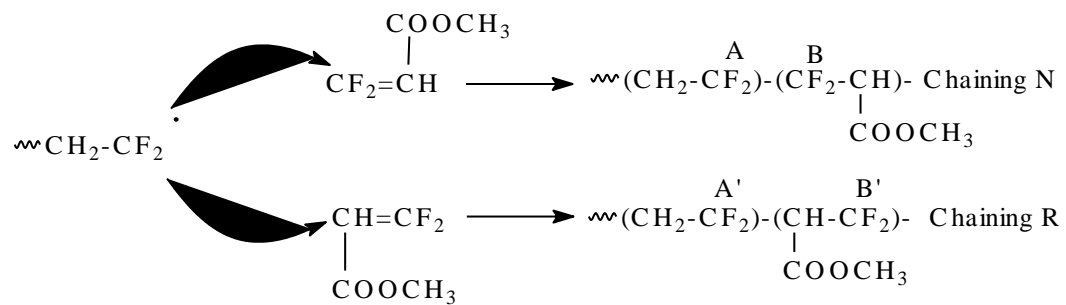

SCHEME 26

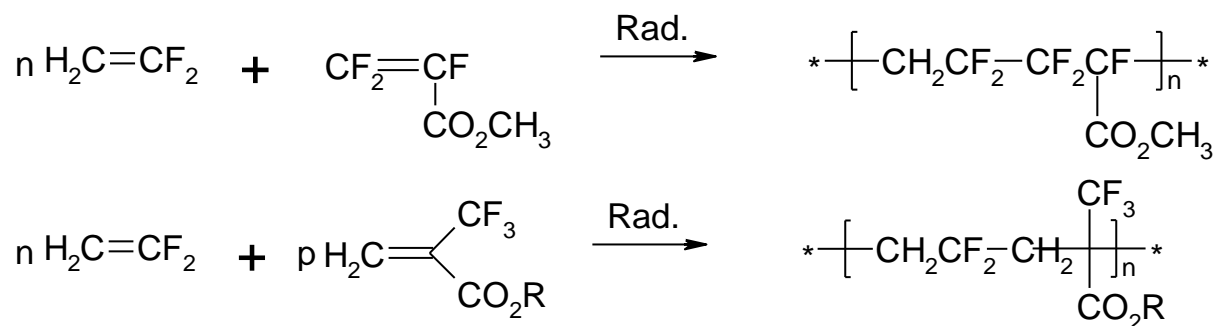

R= H or tBu

SCHEME 27

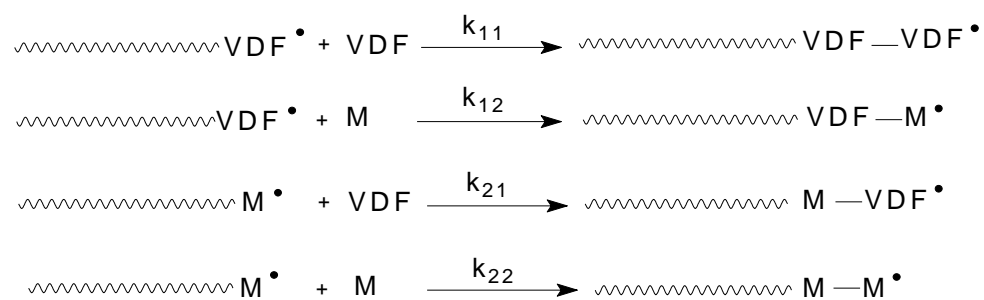

Scheme 27: various equations and rates of propagation in the radical copolymerization of VDF with M comonomer

SCHEME 28

$$r_{\text{VDF}} = k_{11} / k_{12} \text{ and } r_{\text{M}} = k_{22} / k_{21}$$

SCHEME 29

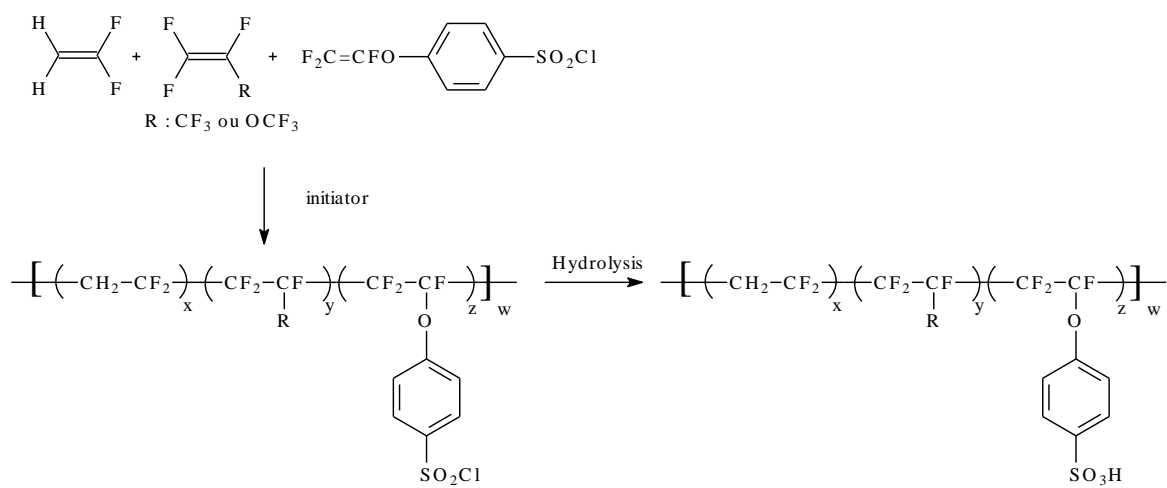

SCHEME 30

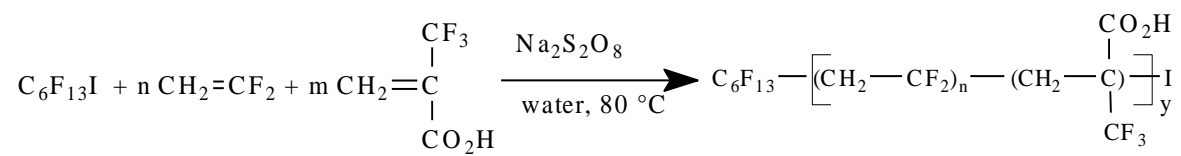

SCHEME 31

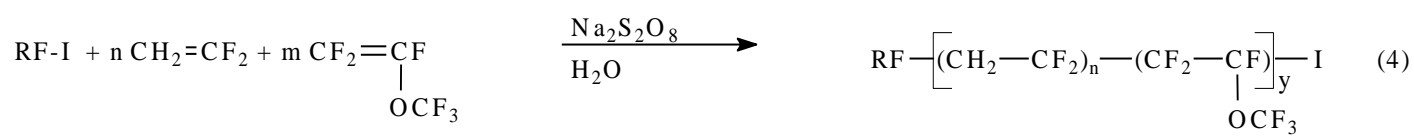

SCHEME 32

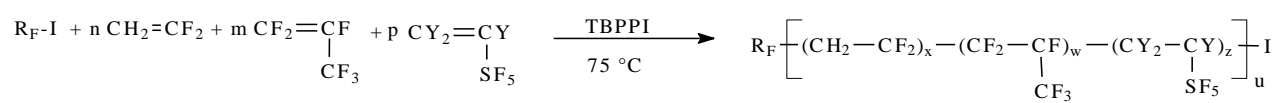

SCHEME 33

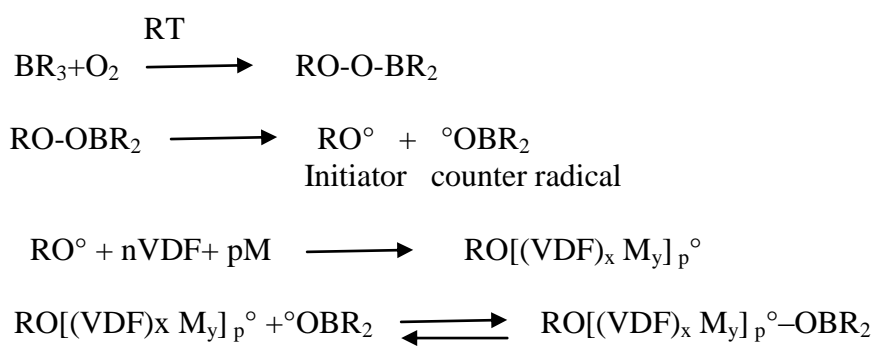

SCHEME 34

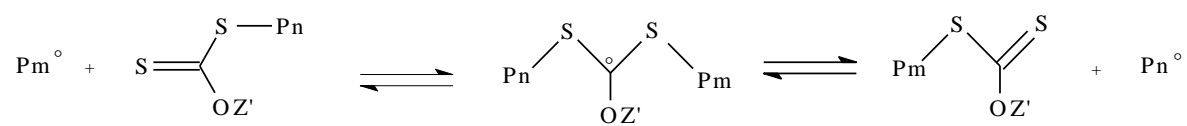

Scheme 34: Xanthate-mediated controlled radical polymerization (the MADIX process)⁴⁹

SCHEME 36

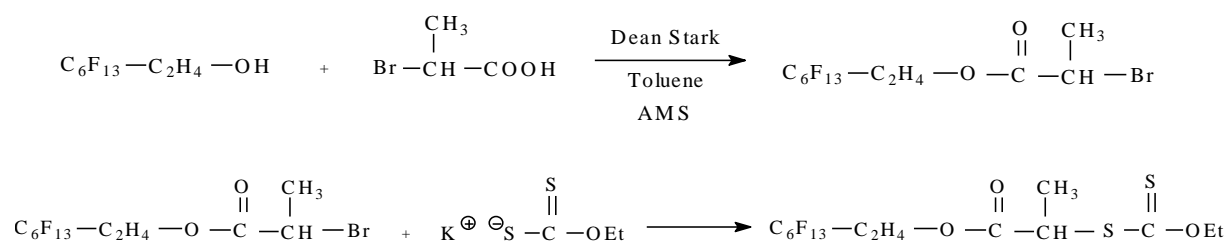

SCHEME 37

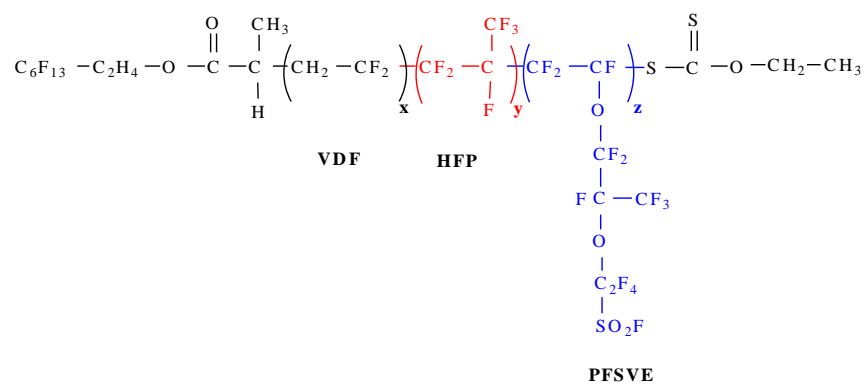

SCHEME 38

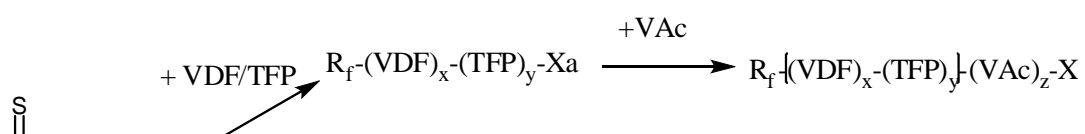

Scheme 38: Synthesis of poly(VDF-co-TFP)-b-Poly(vinyl acetate) diblock oligomer (where Xa, VDF, TFP and VAc represent S-C(S)OEt, vinylidene fluoride, 3,3,3-trifluoropropene, and vinyl acetate, respectively³¹⁸).

SCHEME 39

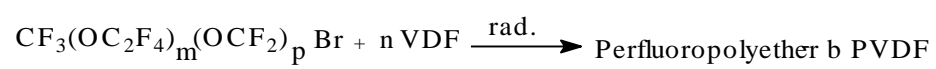

SCHEME 40

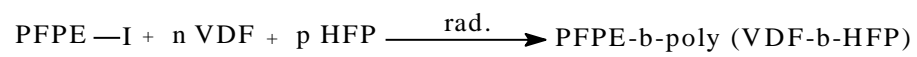

Scheme 41

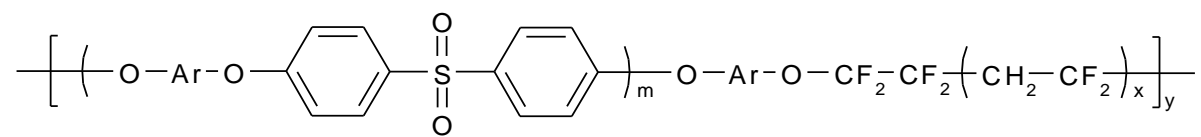

where Ar can be bisphenol, bisphenol A, or bisphenol AF.

SCHEME 42

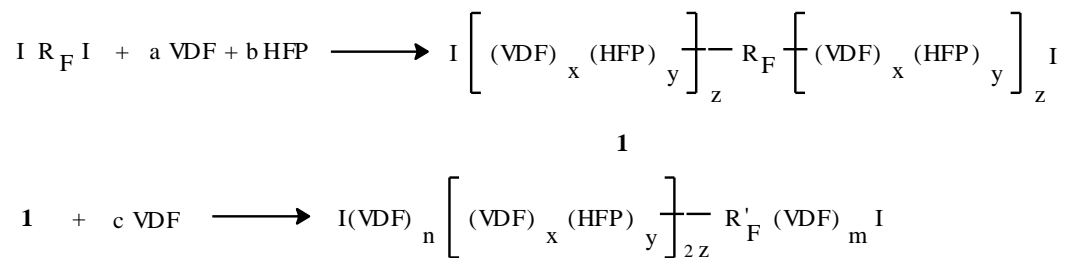

SCHEME 43

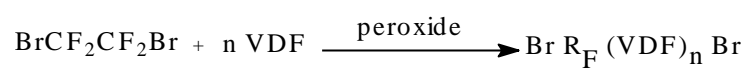

2

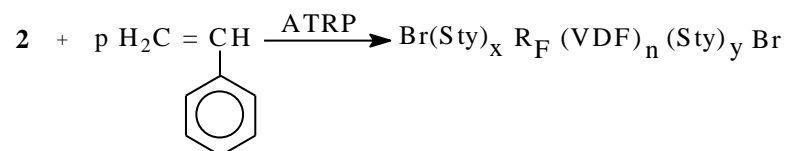

SCHEME 44

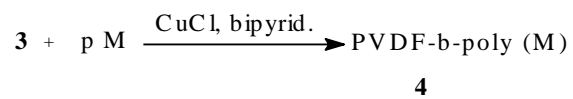
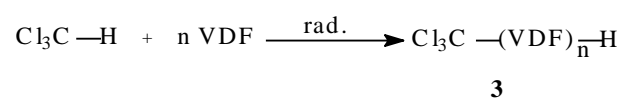

SCHEME 45

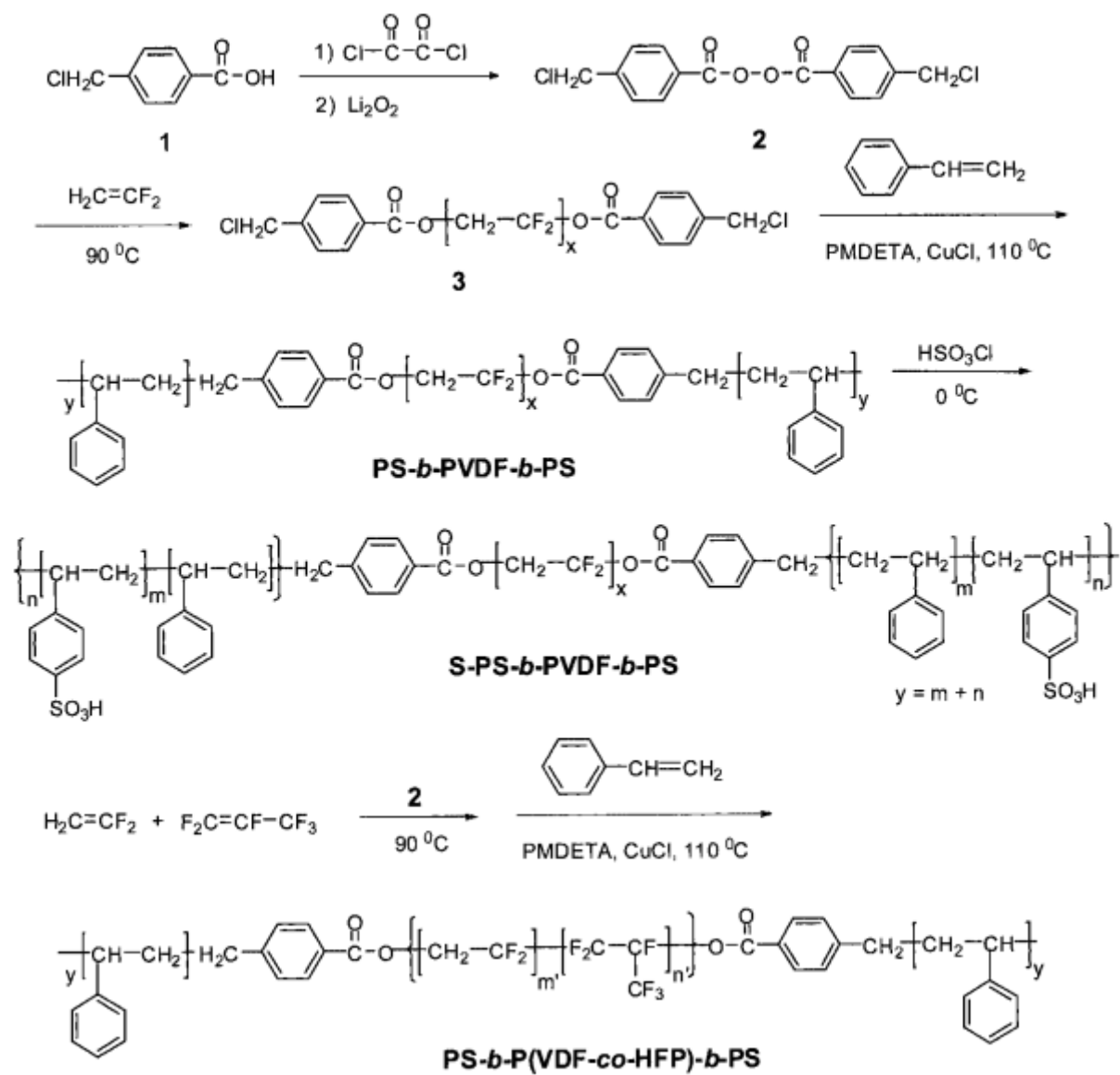

SCHEME 46

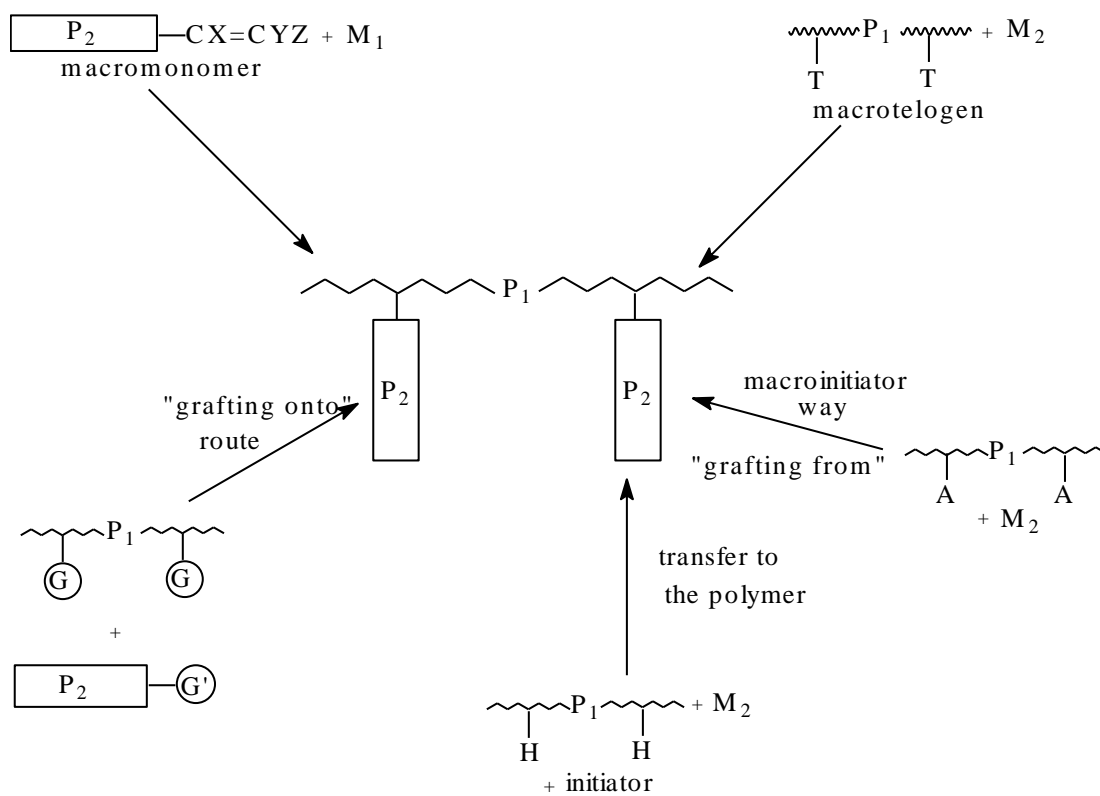

T : transferring group
 A : initiator group

Scheme 46: Various strategies to synthesize graft copolymers

SCHEME 47

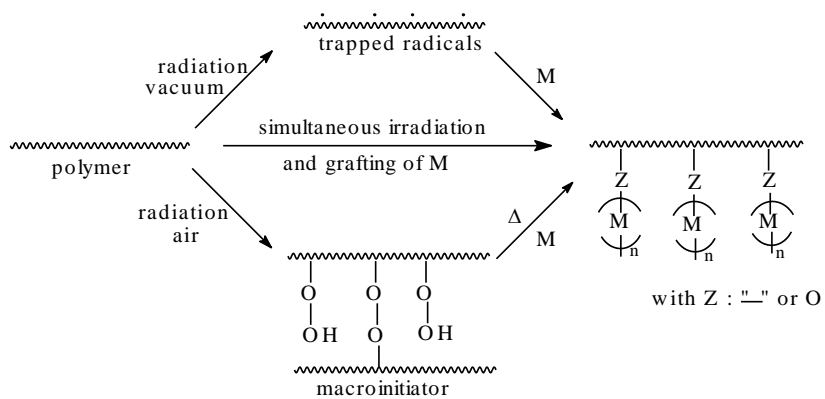

Scheme 47: Various ways to synthesize graft copolymers from radiografting films or powders.

SCHEME 48

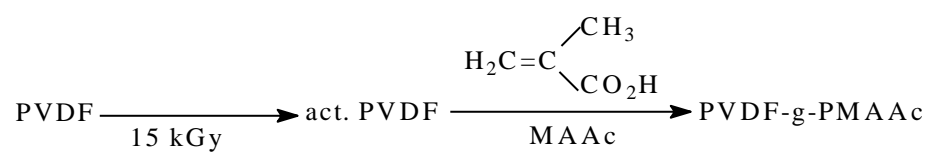

SCHEME 49

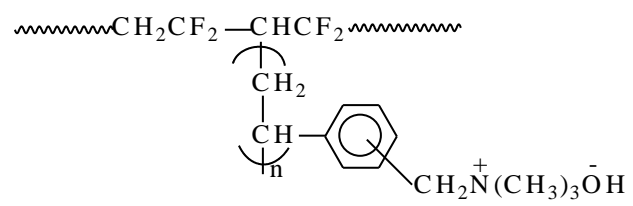

SCHEME 50

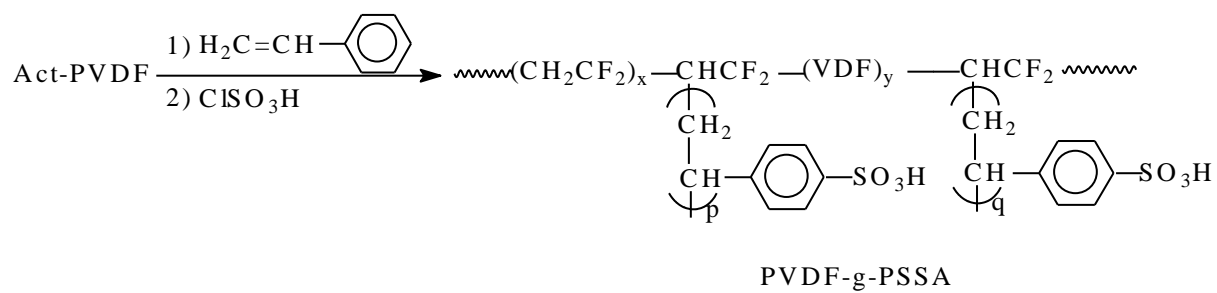
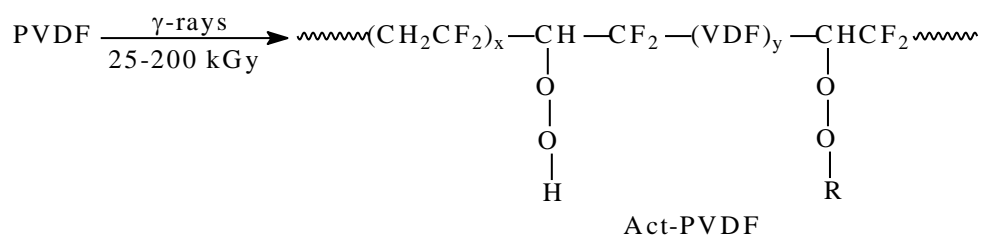

SCHEME 51

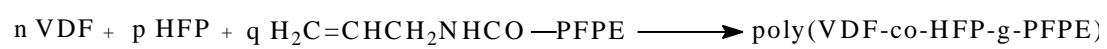

5

SCHEME 52

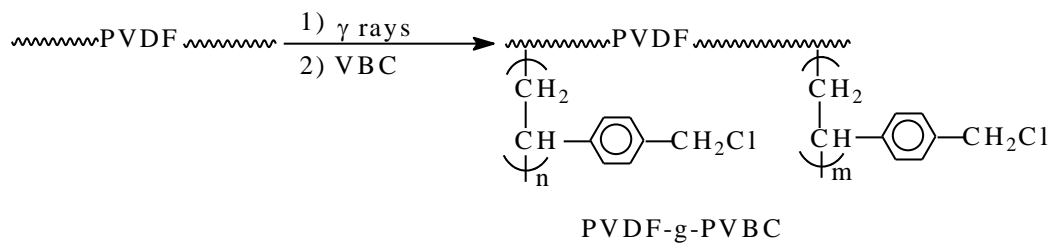

SCHEME 53

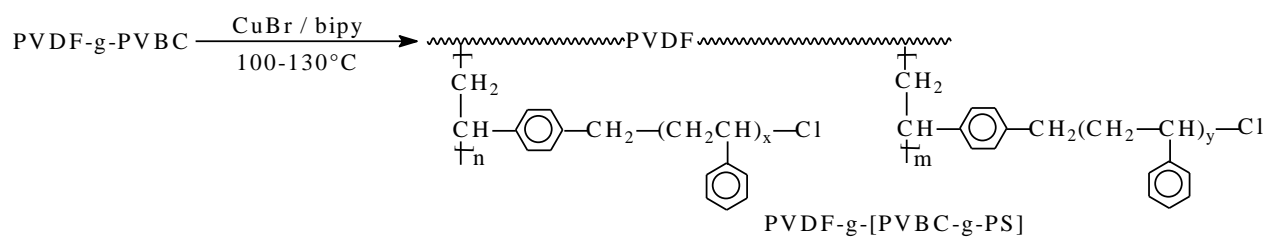

SCHEME 54

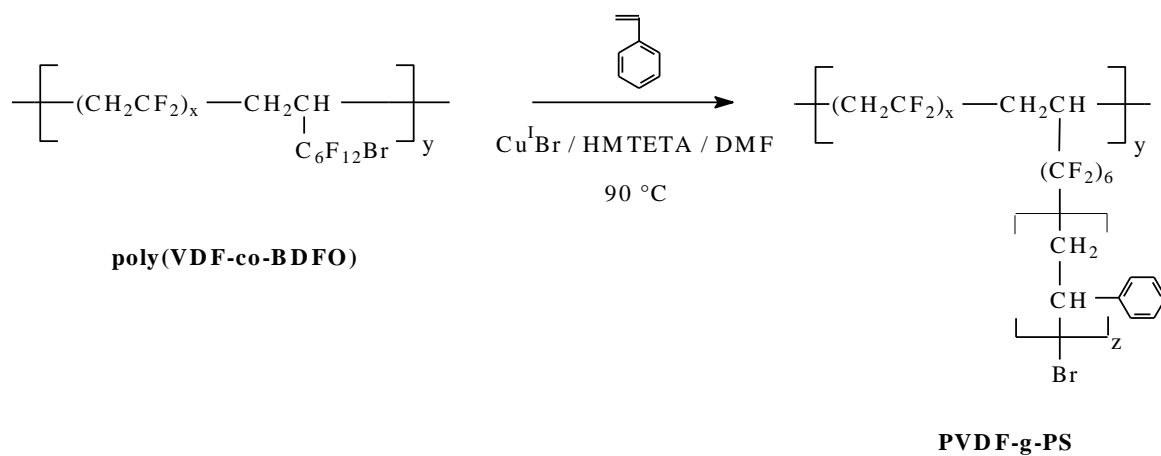

Scheme 54: Synthesis of PVDF-g-PS graft copolymers by atom transfer radical polymerization of styrene with a poly(VDF-co-BDFE) macroinitiator. BDFO, HMTETA and DMF stand for 8-bromo-1H,1H,2H-perfluorooct-1-ene, 1,1,4,7,10,10-hexamethyltriethylenetetramine and dimethylformamide, respectively³⁸³.

SCHEME 55

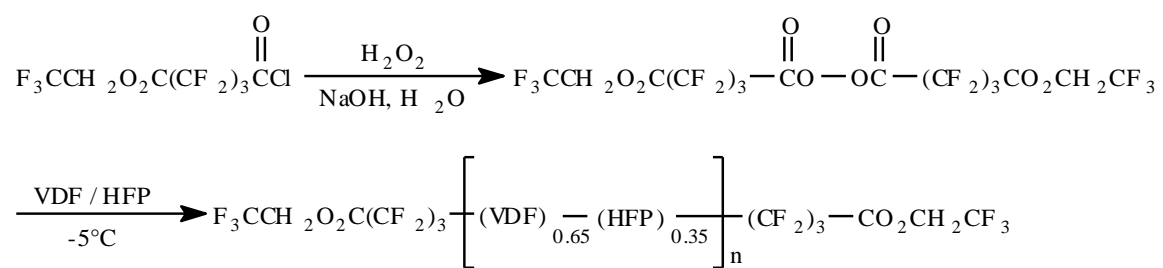

SCHEME 56

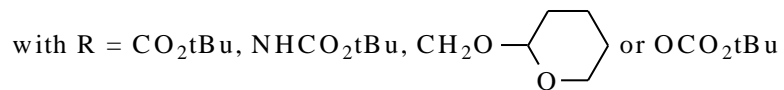
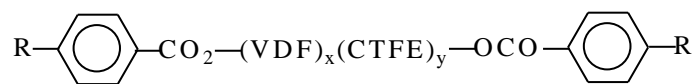
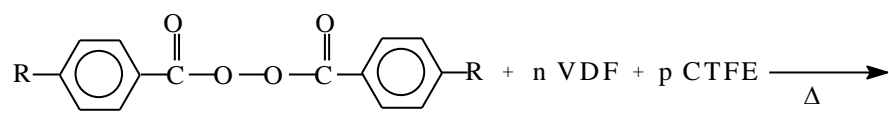

SCHEME 57

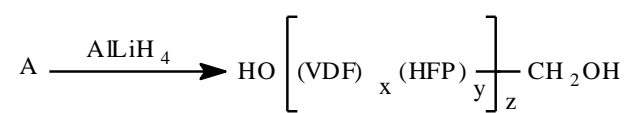
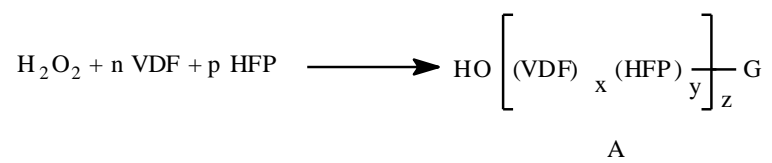

SCHEME 58

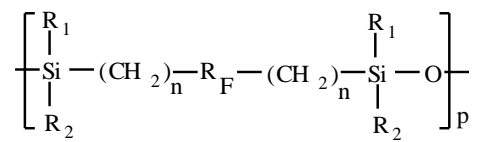

where $R_1, R_2 : \text{CH}_3, \text{C}_2\text{H}_4\text{CF}_3$ and $R_F : (\text{CF}_2)_x \quad x = 1$

$n = 2$

or $\text{C}_2\text{F}_4\text{OC}_2\text{F}_4$

SCHEME 59

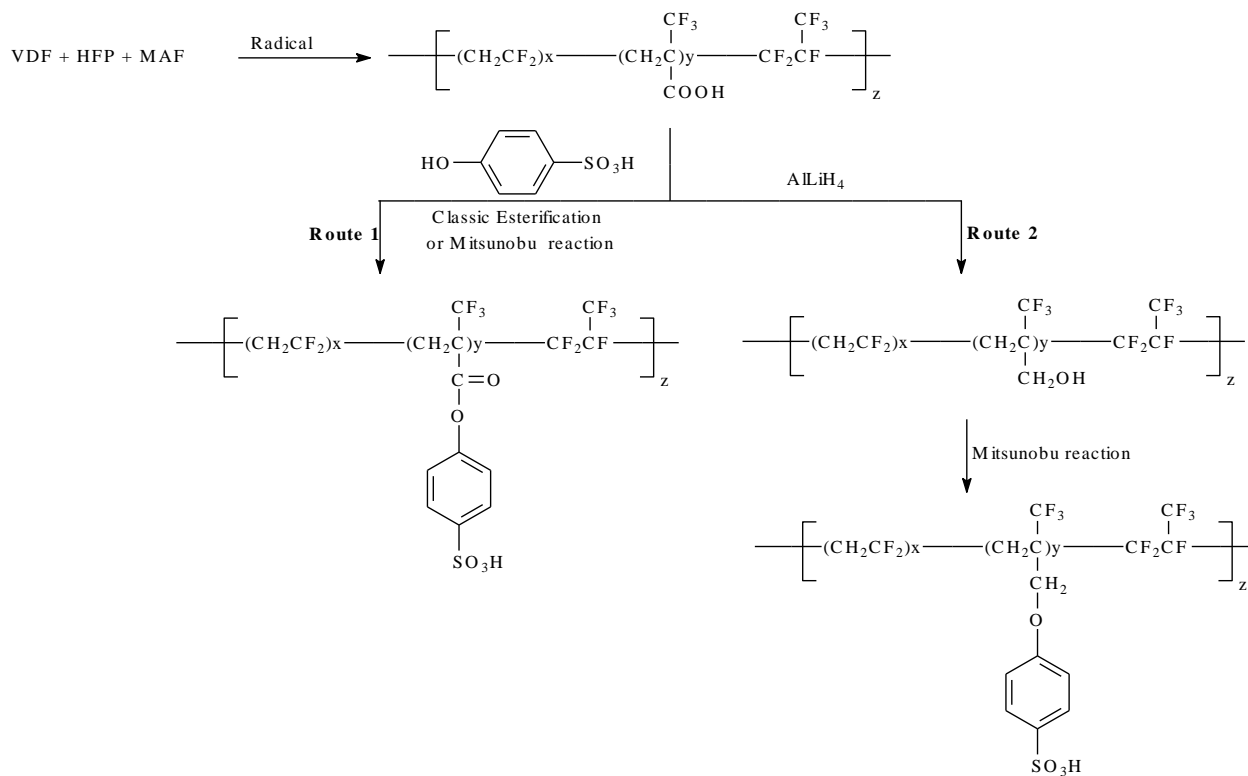

Scheme 59: Obtaining of original fuel cell membranes from poly(VDF-ter-HFP-ter-MAF) terpolymers (where MAF stands for α -trifluoromethacrylic acid)³⁸⁰

SCHEME 60

Scheme 60: Chemical modification of poly(VDF-co-HFP) copolymers by amino sulfonate for fuel cell membranes⁴⁰².

