

# HOW TO MAKE YOUR OWN PROFESSIONAL LOCKTOOLS

by

eddie the wire

Volume **1**

# HOW TO MAKE YOUR OWN PROFESSIONAL LOCK TOOLS

© 1980 by *Loompanics Unlimited*

**Published by  
Loompanics Unlimited  
PO Box 1197  
Port Townsend, WA 98368  
U.S.A.**

## TABLE OF CONTENTS

A Word Of Caution To The Reader .....	4
Forward.....	5
List Of Tools And Supplies .....	6
Beginning Measurements .....	7
Rough Profile Blanks.....	8
The Diamond Pick .....	11
The Lifter Pick.....	13
Snake Picks .....	14
Tension Wrenches .....	16
The Handle .....	18
The Double Tension Wrench .....	20
The Plug Spinner .....	21
The Snapper .....	23
A Tool For Opening Office Equipment .....	25
Tools For Spring Latches .....	26
Tools For The Dead-Locking Latch.....	27
Car-Opening Tools .....	28
Carrying Cases .....	30
A Word On One-Offs .....	31

## **A WORD OF CAUTION TO THE READER**

*The making and possessing of lock-opening tools may be regulated by state and local laws. Check these **before** you start. Although all of the techniques and materials discussed herein will work, neither the author nor the publisher accept any liability whatsoever regarding use of information in this book.*

**More:** *The mere insertion of a lockpick in a keyway constitutes „entry“ (as in „breaking and entering“). Everything you have heard about life in the can is true, so if you want to score big, take my advice and run for office -- **that's** legal!*

*-Eddie The Wire*

## FORWARD

Custom-made professional lock tools (or „PLT“) have several advantages over stock items.

1. A PLT has much greater resistance to bending and breaking than a stock tool.
2. PLT may be sized to work best on a specific make/model of lock, succeeding where the „fits-all“ tool might fail.
3. Stock tool are often hard to get. PLT can be built from hardware store supplies.
4. Finally, locksmiths frequently must invent special tools for a single job. We will discuss some „one-offs“ that are unavailable elsewhere.

Read through this entire book before starting on your set of PLT and you will avoid a lot of frustration. Be prepared, be precise, and your tools will work perfectly.

## LIST OF TOOLS AND SUPPLIES

If you can't wait to begin, list A can be purchased at any hardware, shopping center, discount store and so on. List B is a little harder to run down, but better quality.

### A. TOOLS

1. Grinding machine with  $\frac{1}{4}$ " –  $\frac{3}{4}$ " coarse wheel. (A lot of metal must be removed in some PLT, so a file would be too slow and tiring. A cheap alternative is an arbor mounted stone chucked in an electric drill.)
2. 6" – 10" flat mill cut file.
3. Gun blue.
4. Small ruler
5. Paint masking tape.
6. Scriber or nail

### A. SUPPLIES

1. Three or four hacksaw blades ( $\frac{1}{2}$ " x 12").

### B. TOOLS

(Same as A, above.)

### B. SUPPLIES

1. Two feeler guage stock,  $\frac{1}{2}$ " x .025" x 12" and two feeler guage stock,  $\frac{1}{2}$ " x .035" x 12". (Try to make all your picks from this fine quality steel.)
2. Music wire: 2 feet of .030 - .040 diameter; and 2 feet of .060 - .090 diameter. (Available at hobby shops – no music stores stock this.)
3. Two extra-cheap pin-tumbler rim cylinder locks. (Buy two of the same brand.)
4. And of course, a quiet, well-lighted place to work is good.

Also, any hand tools you may have will make the work that much easier. The above should be considered the bare minimum. Let me emphasize that the purchase of a small bench grinder may involve a medium expense, but it is well worth it in time saved.

Your basic set of PLT will consist of one diamond, two lifters, and two tension wrenches. This will allow you to work 90% of the locks you encounter.

## BEGINNING MEASUREMENTS

Several measurements are necessary to site the PLT to a particular lock, and also to your own opening technique.

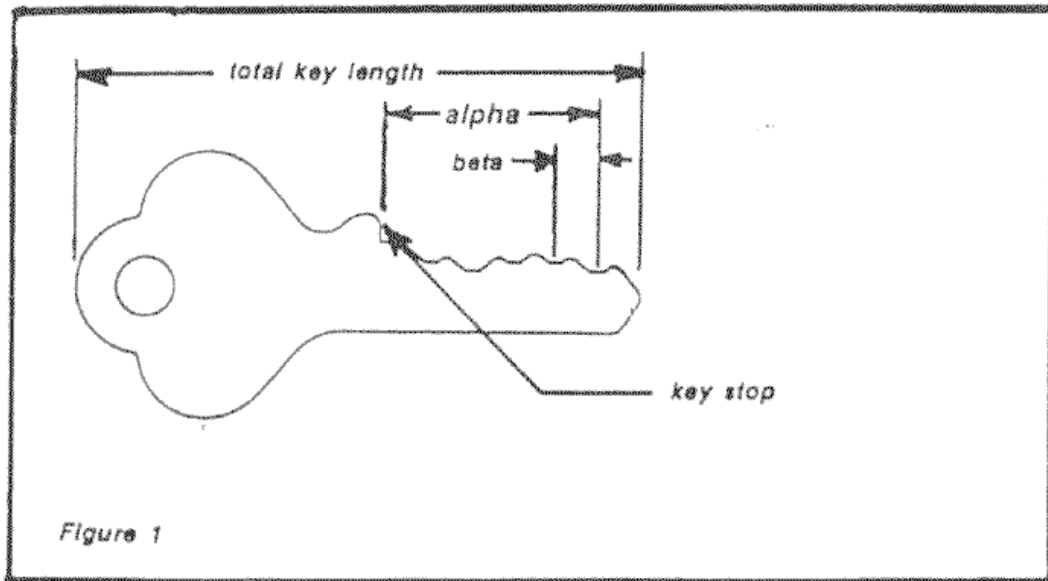

First (alpha) measure the distance from the key stop (the part of the key that butts against the lock face and prevents further insertion) to the exact bottom of the farthest pin cut, as shown in Figure 1. Next (beta) measure the distance between two adjacent pin cuts. Finally grab a pencil (you should be writing down these measurements) and pretend it is a lockpick, hold the eraser end up to a lock as you usually hold your lockpick. If you have never used a pick before, hold it in your usual pencil grip. Mark the point at which the pencil shaft no longer touches any part of your hand, and then measure from the eraser to that mark for the gamma measurement.

## ROUGH PROFILE BLANKS

At this point we begin making rough profile blanks, or RPB. Add one alpha dimension, one gamma dimension, and three beta dimensions together. The total is the RPB overall length. With luck, it may be less than 4 inches, enabling you to cut three RPB from one piece of stock. If you are using painted hacksaw blades, fine lines can be scribed directly onto them. Plain blades and feeler stock must be blued (with your gun blue) to accept layout lines.

Scribe your RPB length lines and cut them apart by grinding on the face of the stock as shown in figure 2.

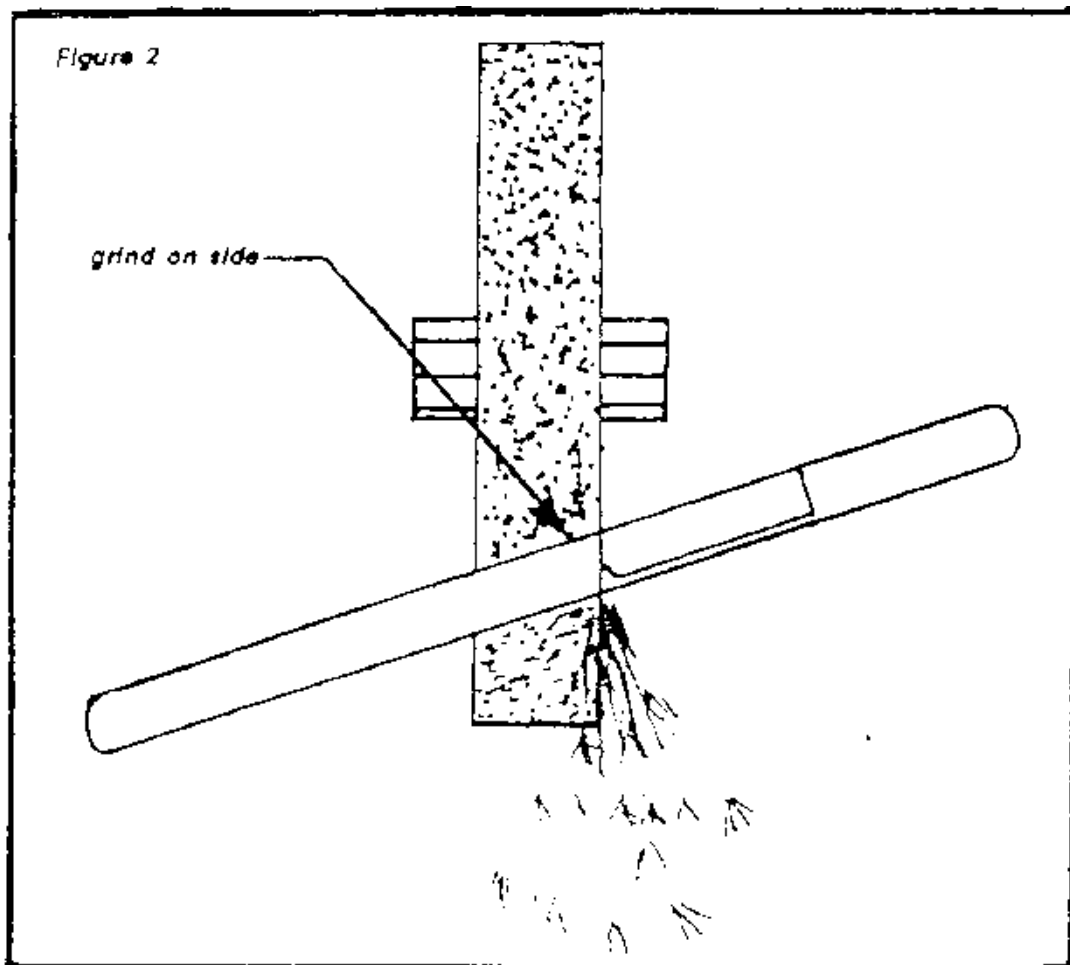

Grind the resulting rough ends of the RPB square, but tape them together in stacks of three to do so. When the RPB stack is end-squared, remove the Tape and layout lines on the top blank, as shown in figure 3.



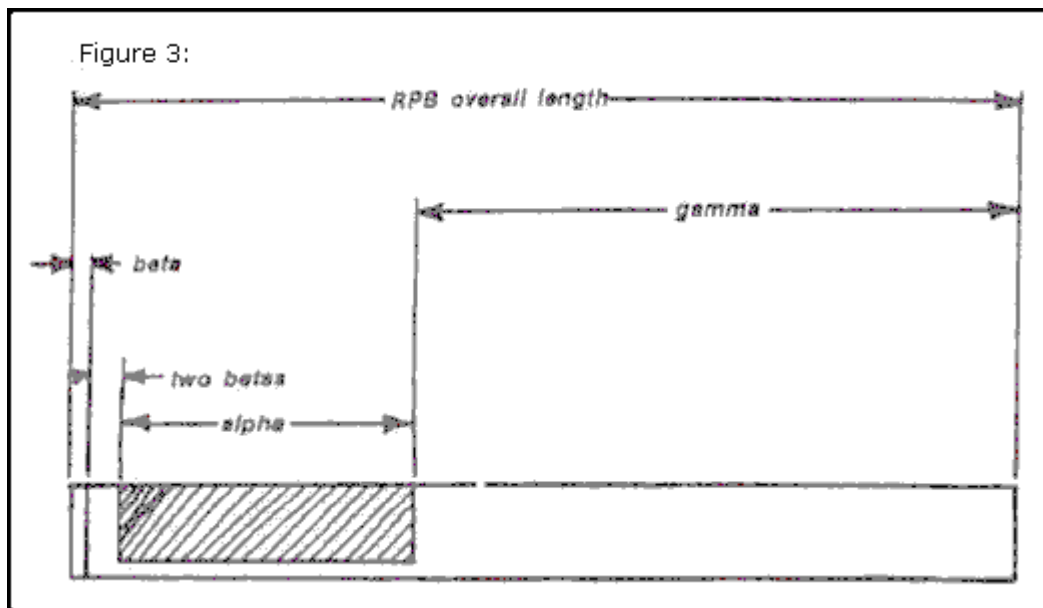

When this is done, restack the blanks and retape without obscuring the shaded portion. The next step is roughing-out.

In any grinding, the heat produced can quickly rise to levels hot enough to un-temper the steel. If any part of a PLT becomes un-tempered (indicated by a dark blue or straw-colored area), it will easily bend at that point and make pin manipulation impossible. Also, no thin steel shapes can be retempered by heating and quenching because they will warp badly. A burned pick is a ruined one. A good way to keep grinding time short is counting to three while grinding, cooling the PLT in cold water, and then starting over with the count. As the cross-section gets smaller and there is less material to carry excess heat away, only grind for a count of two or one before cooling. Having the water immediately below the wheel saves a lot of time and motion. Sharp angles and points on PLT really heat up fast, so cool frequently. Holding the PLT in bare fingers by grinding is another good way to avoid burning (the steel, at least).

Make the cuts in the RPB according to Figure 4. Remember to alternate cuts. If you cut so deep that the PLT has no sideways give, the sides will catch on the wheel and turn the PLT into an *unguided* missile. End your cuts almost on the

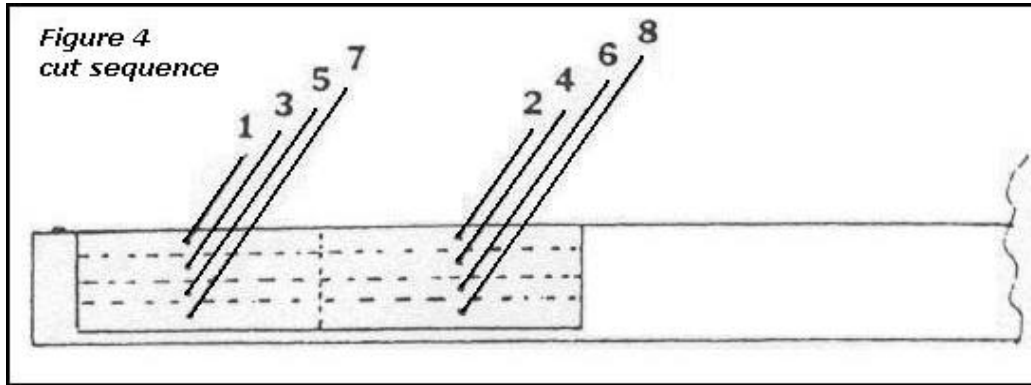

layout lines and finish with a mill file, especially the right angle surfaces.

When the Figure 4 cut sequence is completed, and file trimming is done, separate the blanks. One of these RPB can now be used to trace the outlines for future RPB's. Since locks with identical pin counts (all 5 pin locks, all 4 pin locks, etc.) tend to have closely similar alpha/beta dimensions, one RPB may serve for all your needs, but for the best in accuracy, re-measure for each make/model of lock.

The remaining RPB can be final cut to provide tools of different function and size. the basic PLT set calls for one diamond, so we will cut this profile next.

## THE DIAMOND PICK

At this point, collect keys for your two sample locks and examine the different biting depths. You are looking for the maximum height *difference* between two adjacent biting depths. The chances are that at least one key will show an appreciable height difference, but occasionally just by chance, there will be nothing but slight differences in biting depths. If this happens, examine any keys in your pocket that have the same alpha/beta dimensions, looking for an appreciable height difference (which we will call a delta dimension). Once you find the maximum delta dimension, trace that section of the key directly onto an RPG, as shown in Figure 5.

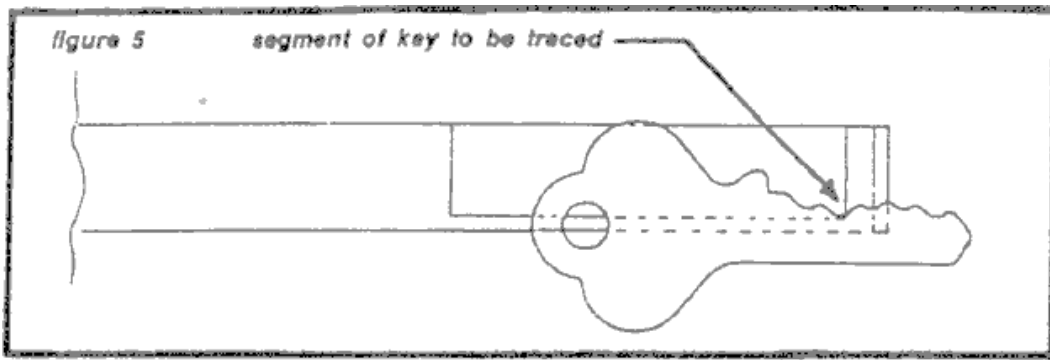

The object is to duplicate the exact angles and height of that selected part of key biting on the RPB. Remember to keep the bottom of the lower of the two biting depths flush with the top of the shank on the tool. when you have traced this, grind to the new outline, taking special care, *not* to lessen the delta dimension at all by grinding the top of the pick end. Your finished product should look like a diamond If it has a flat spot at the top, grind as shown in figure 6 to eliminate the flat spot, while keeping the height the same.

As you expand beyond a basic PLT set, you may want diamond picks with lower height diamonds (delta dimensions). *Note:* A pick cut to the maximum delta dimension can lift a pin to the necessary height without the *shank* of the pick binding and possibly un-picking the lower adjacent pin. A PLT with a lower height delta is, however, useful in special situations and other makes/models of locks. To produce these smaller PLT, simply trace your maximum delta pick directly onto a RPB, and then continue the process shown in

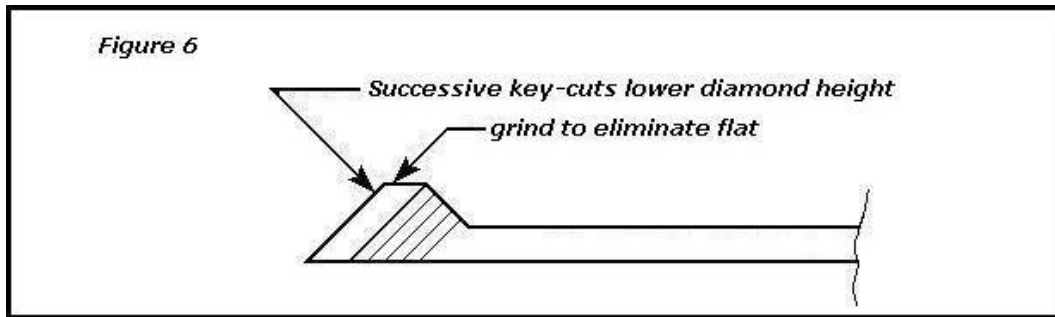
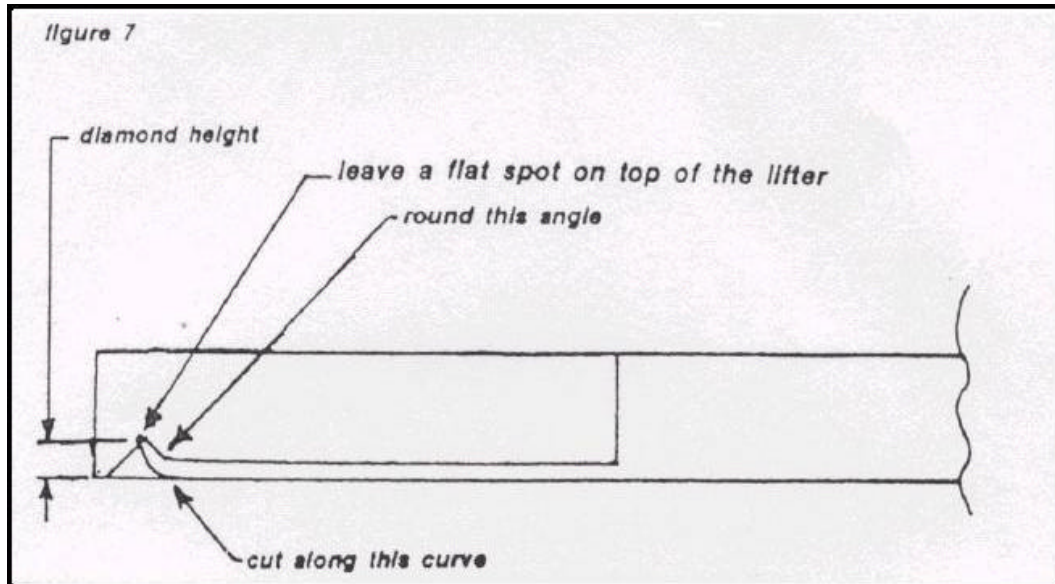

Figure 6, but *past* the point that Figure 6 shows to stop grinding. This will effectively lower the diamond to any desired height. Remember to keep the angle the same or the pick will not easily slide in under the pins.

On to the lifter pick.

## THE LIFTER PICK

The working end of a lifter is merely an upswept curve with a small flat spot on top to hold the pin. Remember a diamond is pointed, but a lifter has a flat on the top. You can cut these PLT easily by tracing your maximum delta profile on a RPB and then making modifications as in Figure 7.



In this re-designing, make sure that the distance from the middle of the flat top of the PLT to the beginning of the upsweep is at least as great as the beta dimension. If not, the sweep might lift or bind on an adjacent pin. Make this PLT in two delta dimensions to complete the pick components of the basic PLT set. The smallest delta dimension among your sample keys would be a good choice for a second pick size.

## SNAKE PICKS

Besides lifter and diamond profiles of various delta heights, there are also half-rounds and multiple-cut PLT (usually called snake picks). Both types are useful when „raking“ the lock with a diamond fails and „lifting“ is too tedious. (To understand this fully, you should have some lock-picking theory down, but if you don't, just trust me.) Half-round profiles are laid out by marking the delta dimensions on a RPB and then tracing various curves whose tops are no higher than this delta dimension. The base of the arc should be wider than two beta dimensions so that part of the curve will lift two or more adjacent pins, unlike diamonds and lifters which work only one pin at a time. Since the arc base is wider than two beta dimensions, a special RPB should be made for this and the „snake“ PLT. A snake PLT attempts to duplicate a two/three/four pin portion of actual key profile, thereby holding up a group of pins simultaneously that would require great skill to pick individually. I suggested that you not use RPB for these profiles, but instead lay out a blank with lines for four beta dimensions as shown in Figure 8.

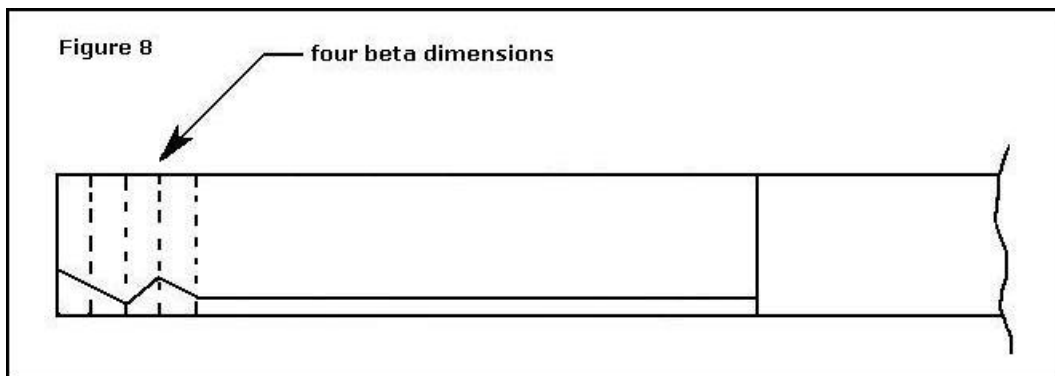

Cutting then becomes a matter of selecting a good profile, tracing it out (keeping the lines exactly in the bottoms of the key bitting cuts), and cutting it out. Notice that you can make up a composite of individual key bitting cuts selected and arranged according to any pattern by marking the depth of cut only, and then connecting the depths with straight lines. Just remember to never exceed the delta dimension between adjacent cuts, or the PLT will not work smoothly or at all, because of too steep angles on the bitting cuts.

The problem is: What sequence or profile of cuts works best? How many Cuts should be used, and how deep? Since the object is to duplicate key action, and all keys are different (if they weren't, you wouldn't need this book), there is no „best“ profile for all Locks.

One approach is to cut a profile that works on a sequence difficult to open by lifters and diamonds, such as:

- deep, shallow, deep, medium
- deep, shallow, deep
- deep, shallow, medium

These lift one or two pins high, while lifting adjacent pins only a little – something lifters cannot do. Experiment also with the following profiles:

- deep, medium, shallow, deep
- medium, deep, shallow
- deep, deep, shallow, medium

Another concept to try out is half-depth profiles. Keys are usually cut according to steps or increments of cut. An average system might have 9 – 10 steps of key biting depth, even though not all are present on one key. By cutting one or more of your PLT biting depths either high or low by exactly one-half of this step, you may increase the number of combinations the PLT will work. This is especially true of worn or cheap locks with loose-fitting parts. The rule here is experiment. Some profiles may not open any locks, in which case they can be re-cut to other profiles. Usually a „snake“ PLT is a last resort, but some can be very valuable.

## TENSION WRENCHES

Two tension wrenches are required to complete the basic PLT set. Start by cutting off a 6 inch length of .060 - .090 diameter music wire and bend as shown in Figure 9.

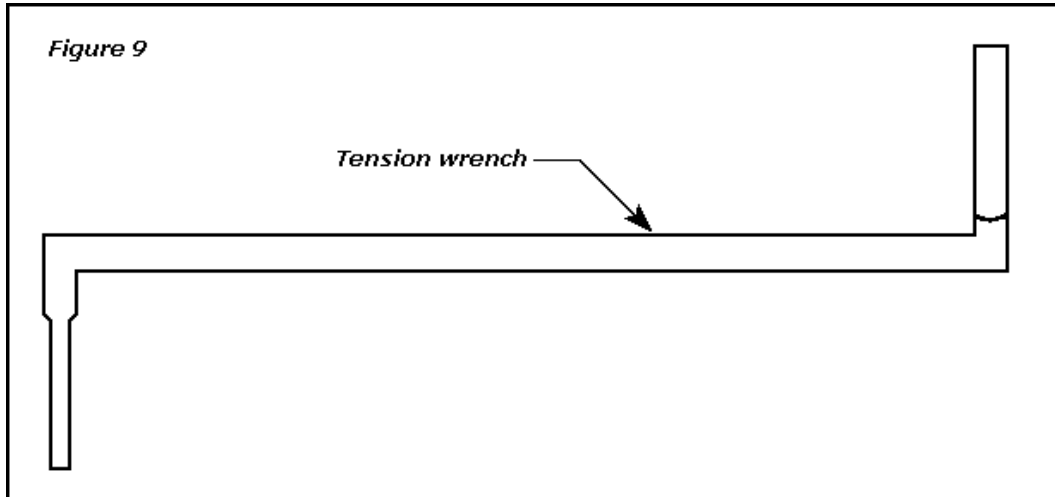

Now go to the wheel and grind the flats indicated, the object being to obtain ends with rectangular cross-sections. Test for a tight fit as the grinding progresses by trying the tool in a keyway. Try also to grind another wrench in which the flats have a slight taper getting smaller near the tip. This will permit a tight wedge fit and thus increase the feel and control of the wrench. Wrenches with a loose keyway fit seem to work better with jerking or raking pick procedures, while wrenches with a tight fit give more control in lifting pick procedures.

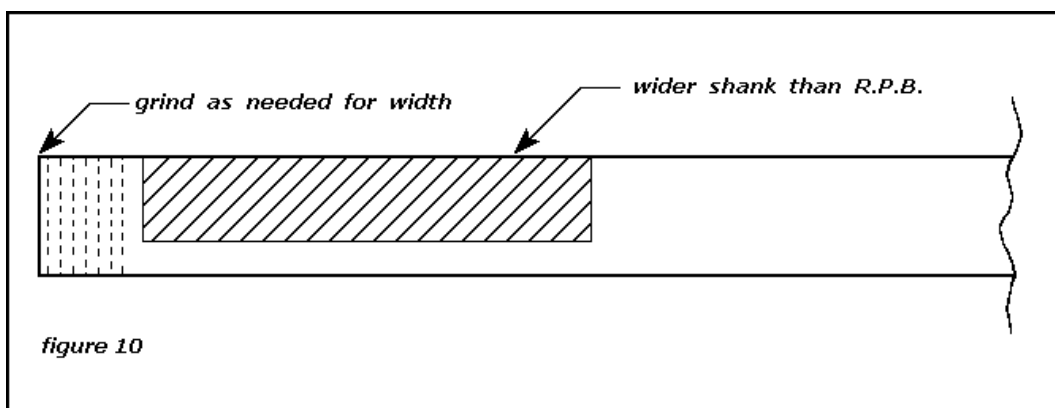



Tension wrenches for disc tumbler locks can be cut in similar fashion, but with  $\frac{1}{4}$ " long legs, -- or RPB can be used, altering only the end to produce different widths as in Figure 10.

(see previous page)

A shank wider than one-sixteenth inch will also give more turning tension if needed, and this type of tool can also be double-ended. Satisfactory wrenches can also be cold formed from .030 - .050 music wire as shown in Figure 11.

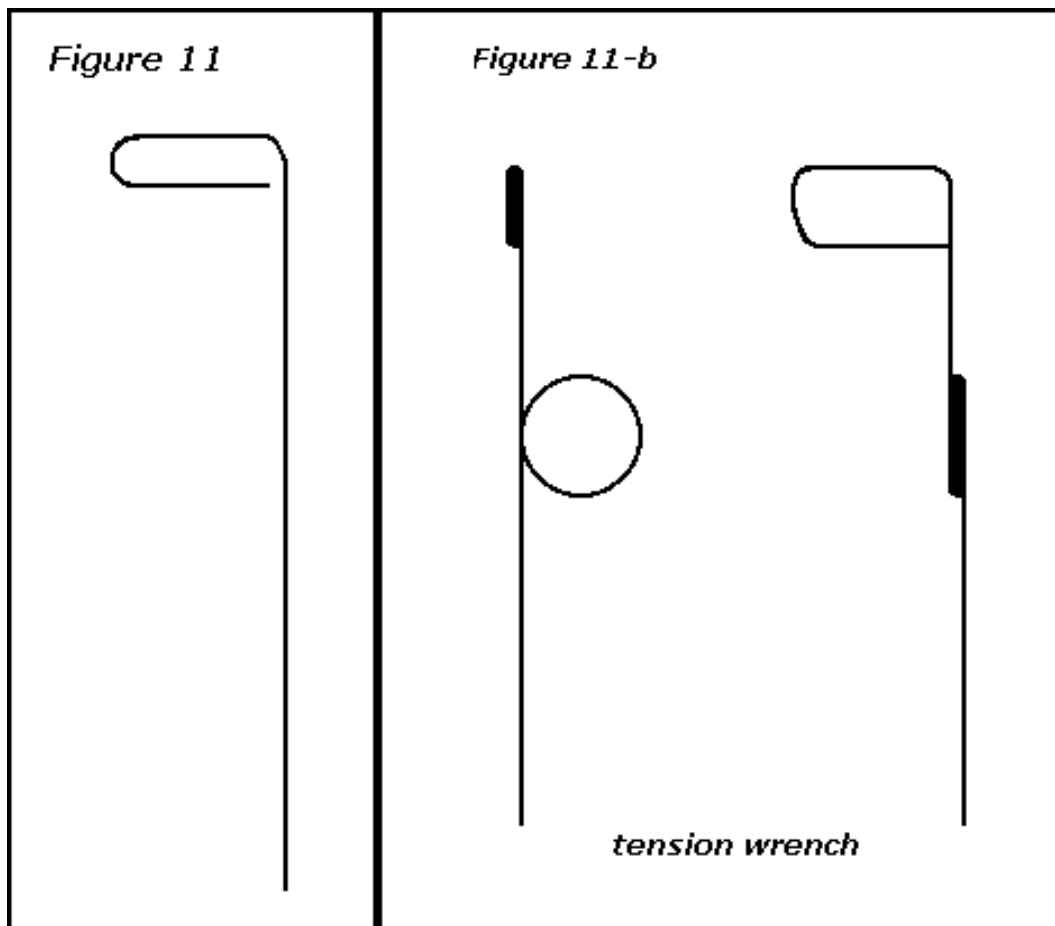

The wrench in Figure 11b has a spring loop incorporated in the shaft. This design is good for extremely light tension and tends to maintain the same turning force despite increased bending of the shaft. The smaller the spring loop, the higher the turning force.

## THE HANDLE

The handle of your basic PLT set is the next subject. The easiest answer is to file or grind smooth the sharp angles on the handle and use as is. A tool treated like this is a little hard to use, but offers good control and stores easily. Storage is important if you carry your PLT set in the wallet carrying case described later.

For simple handles, try slipping a piece of 3/8" i.d. vinyl tubing over the standard 1/2" tool end, or a smaller size tube, if it will fit. Another easy answer is a generous wrapping of vinyl electrician's tape. You can insert matchsticks, short pieces of tubing and other spacers as you wrap the tape. A spacer on each side of the PLT handle, for example, will make it rounder and easier to work. For the ultimate, however, try a silicone rubber molded handle. Hold the pick in working position and build up the spaces with modeling clay. Make sure that at least one-sixteenth inch of clay covers the tool all around and that all excess clay squeezed out in the fitting process is trimmed away. The object is a minimum of clay, but a perfect fit. It may help to actually work the pick in a lock while fitting to ensure the proper contour. Next, lay the finished handle aside and make a mold support rod by splitting a pencil lengthwise with a knife. Clamp the two split halves back together with a rubber band and push the makeshift support endwise through the clay to clamp around the end of the tool stock as shown in Figure 12. Reshape the clay if necessary.

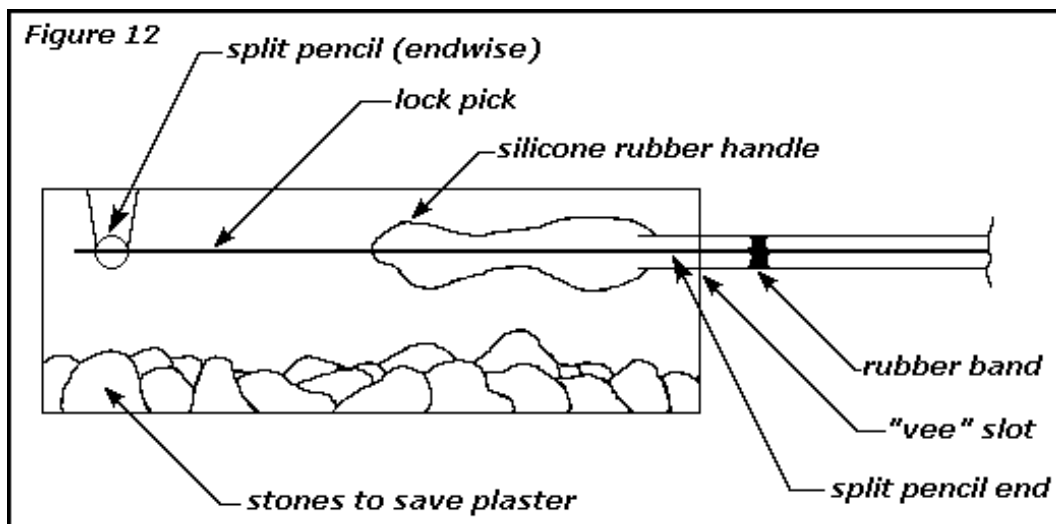

Now install another makeshift clamp perpendicular to the shank and find a plastic dish or waterproof box slightly larger than the handle, as shown. If necessary, put sand, marbles, or whatever will take up space in the bottom and save plaster of paris, leaving a ½" gap between handle and filler material. Now cut out „vee“ slits for the clamps and suspend the pick halfway down in the bowl. Following manufacturer's instructions, mix enough plaster of paris to come up exactly halfway on the pick handle. Pour the plaster, being careful not to drip on the top half of the handle. As the plaster gets semi-solid, put several large drips on the surface to act as protruding „keys“ for the top mold to register in. When the plaster hardens, use a little more clay to seal above the pencil clamps where the „vee“ grooves are, then spray lots of hair spray over the existing plaster, inner bowl and handle. Let dry. Now cover the top half of the handle with fresh plaster and let dry. After curing for half a day, the mold should separate easily and the pick, clay, and rear clamp can be removed. The clamp perpendicular to the pick shank should be retained to aid alignment of future picks.

To use your completed mold, spray hair spray over both parts of the mold and let dry. Now select a pick and grab your tube of silicone caulk. Using the tube nozzle carefully, fill the lower and upper halves of the mold and put a slight amount on each half of the pick handle. Now lay the pick handle in the middle of the mold rubber and put the top half on. Rubber band the two together and lay the mold upright with the hold made by the absent rear pencil clamp pointing down. If you have trouble getting a good mold seal, try putting a thin layer of petroleum jelly on one face of the mold for the next handle. After the rubber cures, separate the mold halves and trim any excess seepage from ends and side.

The completed handle should be dusted with talcum powder. Also avoid prolonged exposure to direct sunlight (the handle, not you).

## THE DOUBLE TENSION WRENCH

In addition to picks which enter the keyhole, there are other PLT that can make lock opening a lot easier. First, let's discuss the double tension wrench. As Figure 13 shows, this wrench is constructed by bending a foot of .030 - .040 music wire into a sharp „V“ shape and then bending the tips at a right angle by grabbing simultaneously with pliers.

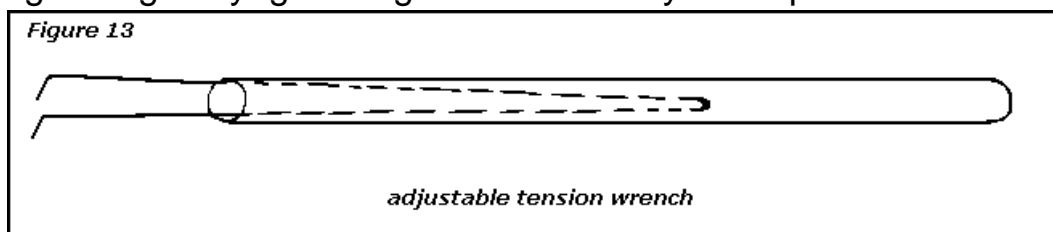

Make the tips about  $\frac{1}{4}$ " and grind them down evenly after bending to about one-sixteenth inch. Then insert this piece in a handle of  $\frac{1}{8}$ " i.d. tubing (brass or aluminium) 6 inches long. Careful bending of the angle of the „V“ will allow you to alter the spread of the tips, to fit the top and bottom on any keyway, by sliding the „V“ in and out of the handle. You may have to wrap some tape around the very bottom of the „V“ to make a tight friction fit in the tube. This tool is very useful for keyways where inserting a regular tension wrench would obstruct free movement of the pick. Some pick experts use this type of wrench exclusively -- try it for yourself.

## THE PLUG SPINNER

The next PLT is something every pick expert should carry. Occasionally you will succeed in picking a lock only to find that you are on the locked side of turning, and if you reverse the turning towards unlocking, the pins will fall back into the holes, and you must start over. However, a plug spinner applies a sudden forceful rotation to the plug and, by applying a centrifugal force to the pins, bypasses the locked position and unlocks the plug. you need the following materials:

- One piece  $\frac{1}{4}$ " diameter music wire (for shank)
- One piece .030 diameter music wire, 18 inches long (for spring)
- One piece of tubing that slips over the above music wire (the fit should be precise).
- One flat stock, brass or aluminium,  $1\frac{1}{2}$ " x ten inches x one-thirty-second inch (these dimensions are approximate).
- One machine screw  $\frac{1}{4}$ " x  $\frac{3}{4}$ ". with two washers and nut
- One flat stock  $1\frac{1}{2}$ " x 4 inches x one-thirty-second inch

Start by grinding two parallel flats 1" long on one end of a ten inch piece of  $\frac{1}{4}$ " o.d. music wire. This is the same cut that you make for tension wrenches. Cut until a thin blade is formed that will fit in a keyway. Now drill a one-sixteenth inch diameter hole in the middle of the blade as shown in Figure 14. Finally, bend one inch of the other end into a right angle and then another one inch section back again, forming a crank. A vice and hammer may be necessary for the bending. That wire is *tough!* Next cut a piece of tubing as long as the flat stock is wide, and set it aside. The next step is to form the flat stock *around* the music wire. Try to follow the curve of the wire as much as possible -- a pair of pliers may help to do this. After the stock has been formed, remove the wire, thread the tubing section onto the end and form the flat stock over the tubing/wire combination. Now place one of the washers on the flat stock so that the top edge just touches where the stock starts to curve. Hold the washer in this position, and mark the center for drilling a hole. Now remove the washer and drill the hole, then put a washer on the bolt, and finally the nut. Tighten this assembly, but check for rotation of the music wire. Do not crush the tube.

The next step is to insert one end of the .030 music wire in the hole drilled in the ¼" music wire, and bend it back around the .030 wire, locking the end. Now use your fingers to guide the wire around the ¼" shaft, while you turn the crank end. You are in effect winding a spiral spring up to the flat stock handle. Leave about two inches of wire and wrap a loop or two around the machine bolt under the washer on the head side on the handle to anchor the other end. Finally drill a hole in the 1 ½" x 4" x one-thirty-second inch stock piece and put it on under the washer on the nut side to act as a trigger.

To use, first wind the crank in the opposite direction of what you want the plug to turn. When tight enough, lift up the trigger to block the crank from turning then insert the blade in the keyway of a wrong-picked plug. Hold the tool by the handle and, watching your fingers, release the trigger. Presto! If you have trouble, try winding the spring tighter. You may also find that two tools, a left-hand and a right-hand wound spring, will allow you to tighten the spring rather than winding the spring in some cases. An unwound spring does not spin as forcefully.

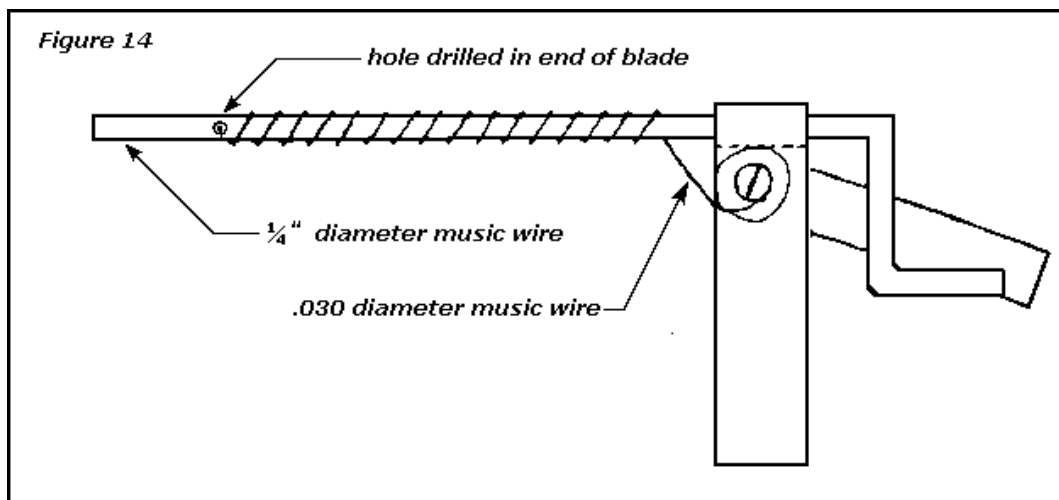

## THE SNAPPER

Another tool that is very useful is the snapper. For this tool from one-sixteenth inch o.d. music wire 18 inches long. Start bending with the hook end and proceed back.

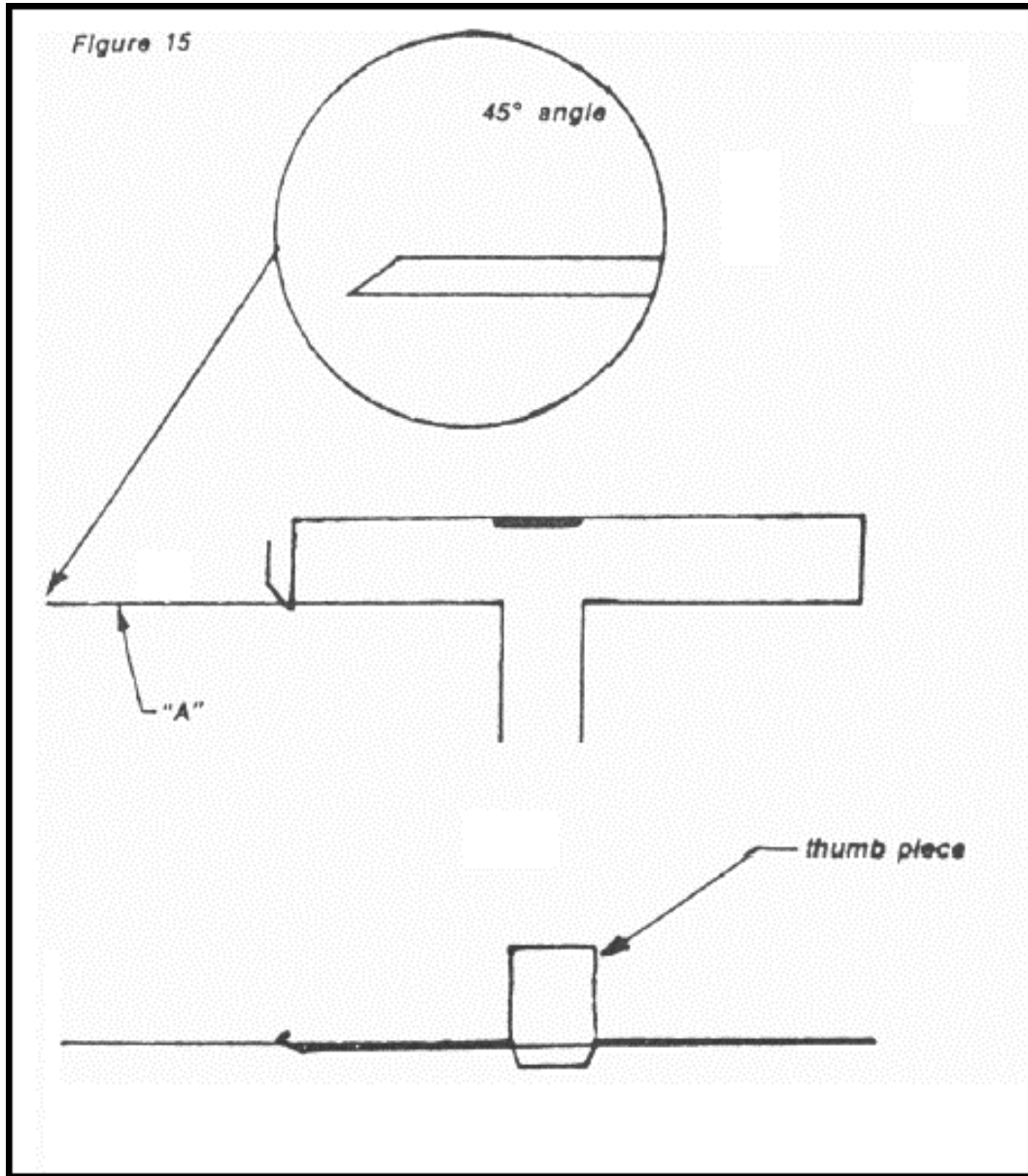

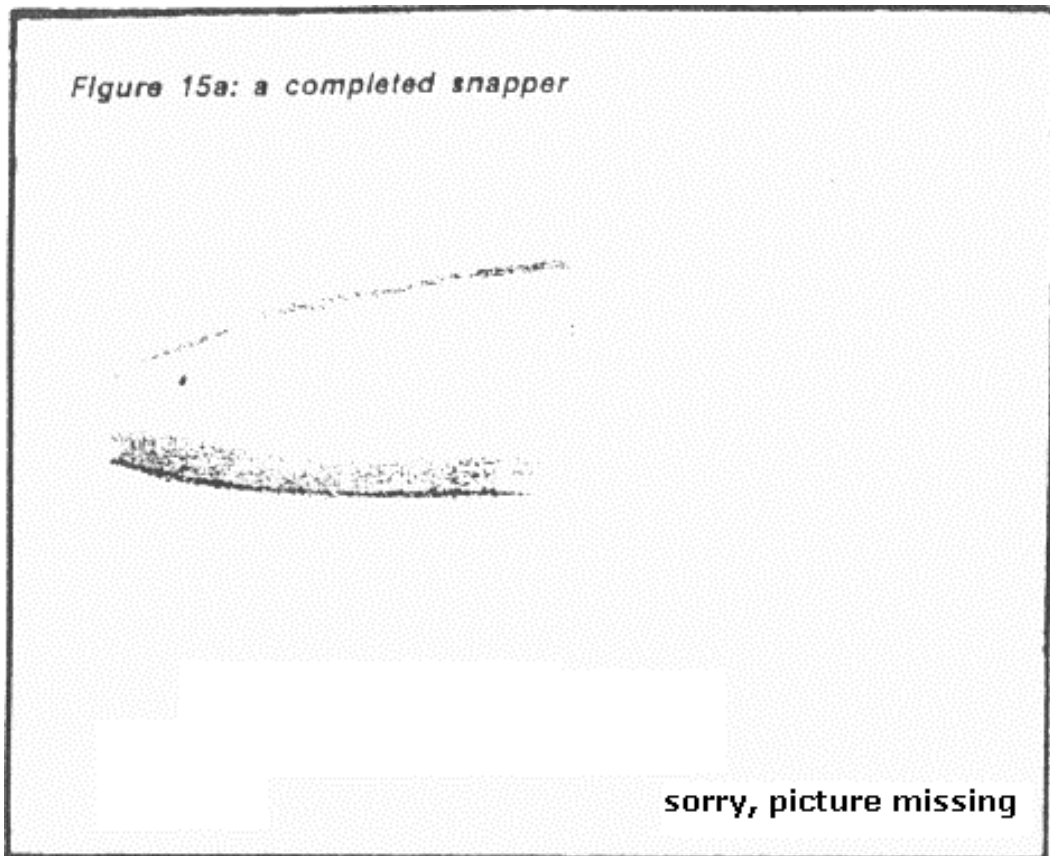

When you get to the "A" end, hook it in and cut it so that there is 1½ inches sticking past the loop. Grind flats as before on the sides of the wire so that it will fit in under the pins like a pick does. Be sure to grind at least one inch of the rod. Then grind a 45° taper on the end to enable it to slip under the pin ends. You may also want to tape the handle and the thumbpiece. This tool is a vibration pick. The ground end is inserted to contact the bottoms of all the pins in the lock. Then a tension tool is inserted in the keyway. Hold the tool by the handle and push down the thumbpiece, then suddenly release, allowing the loop to hit the shank, transmitting vibration to the pins via the shank. By varying the tempo of snapping, and the level of tension exerted, a point will come when all of the top pins in the lock will be in the air. At this point, the lock plug will suddenly turn. A good operator can often open a lock with one snap.



## A TOOL FOR OPENING OFFICE EQUIPMENT

A tool useful for opening office equipment locks can be made merely by bending a .030 music wire in a "J" shape as shown in Figure 16.

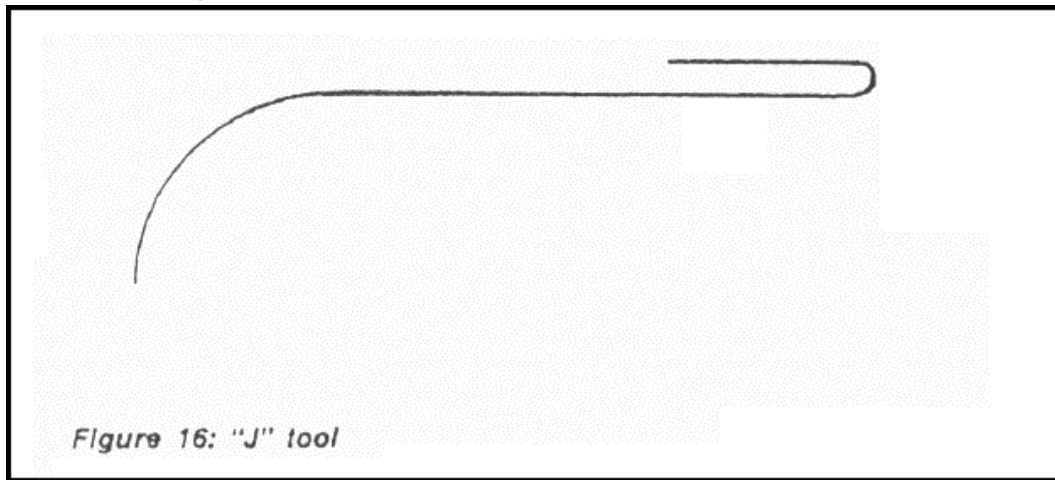

Wrap tape around the loop to form a handle. This tool is inserted into the bottom of the keyway, ending with the "J" end pointing down at the rear of the lock. On many locks this end will engage the same slot that the cam on the tail of the lock plug engages. Then you can twist the handle and bypass the lock entirely. Manufacturers lately have wised up, though, and put a blocking pin in to prevent this. Even then, this technique is sometimes still useable -- and for older equipment, it's great!

## TOOLS FOR SPRING LATCHES

Now let's take to the tools that act on the spring latch common on most exterior and interior lock sets. This is the wedge-shaped latch that locks automatically, not the bolt that must be locked by key. Those latches that are exposed, i.e., the latch can be seen, are a snap to open. A half-moon shim cut from one-sixteenth inch thick stock as shown in Figure 17 can be inserted behind the latch and levered against the bevel to open.

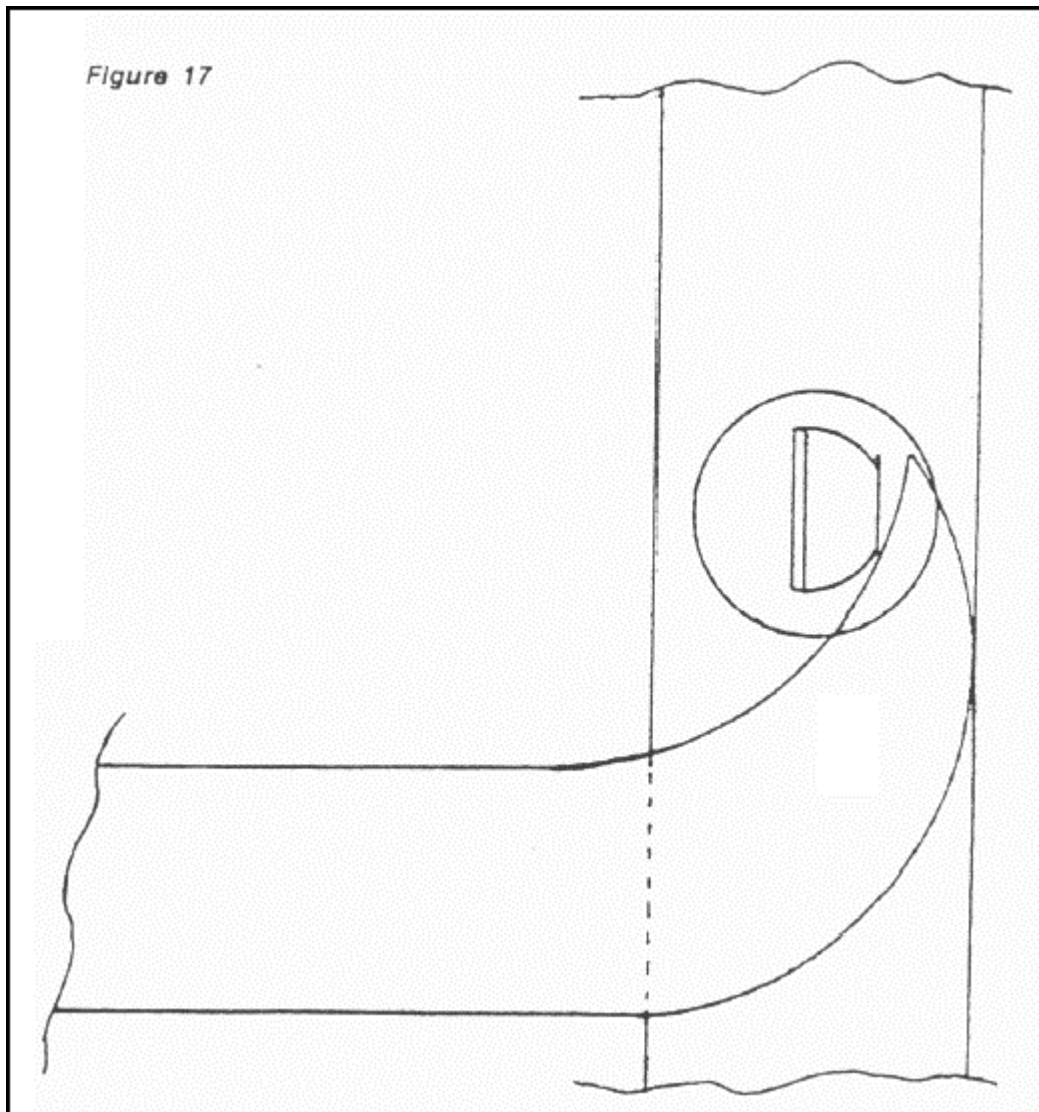

## TOOLS FOR THE DEAD-LOCKING LATCH

A dead-locking latch, consisting of an extra bar of metal parallel to the latch that does not enter the latch strike, but instead bolts on the strike plate, will prevent you from doing the half-moon bit, but I have seen doors fit so loosely that by forcing the door more tightly closed, the dead-locking bar suddenly snaps into the strike pocket. This releases the dead-lock and the latch can then be shimmed as usual. If the latch is not exposed (is covered by the stop), then you know it bevels the opposite way. The traditional plastic strip or credit card works fine, unless the traditional homeowner has installed nails, plates, cut a saw slot, or otherwise made it impossible for the card end to round the corner. In cases like this, the "Z" wire can save the day. As Figure 18 shows, the "Z" wire is only a .060 or one-sixteenth inch o.d. music wire with two right angle bends, inserted and pivoted as shown.

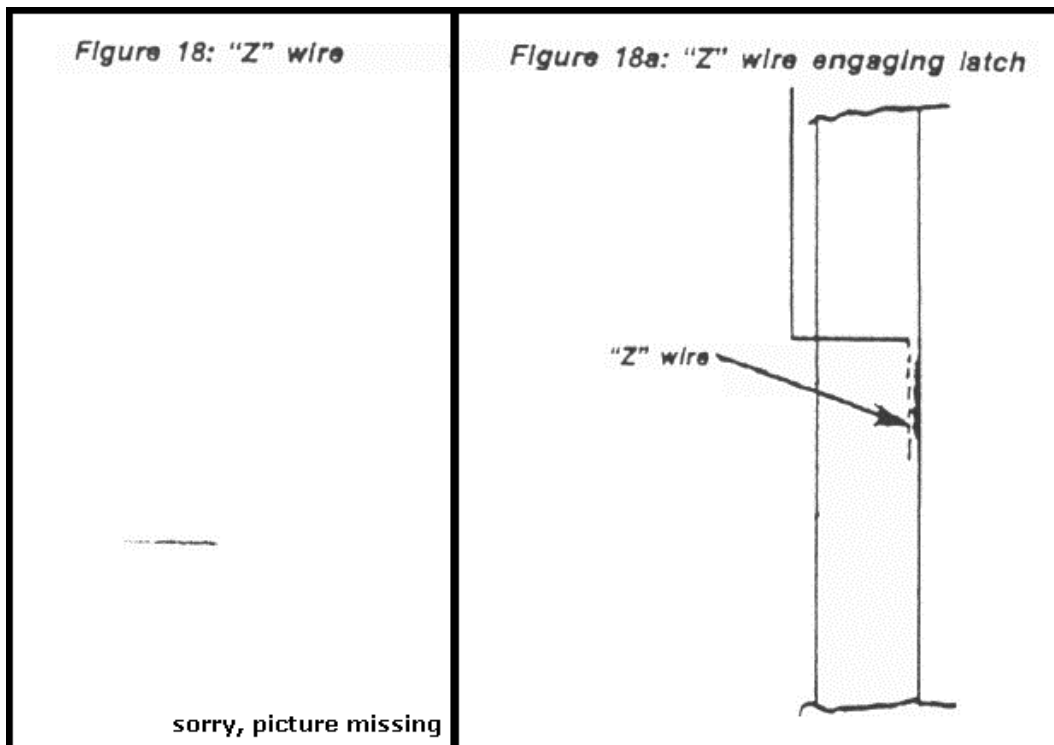

You will probably have to push on the door to gain clearance for inserting and pull on the doorknob while working the tool. If a dead-locking latch is encountered in a non-exposed latch, attack the lock with your PLT and forget the latch, because it won't budge.

## CAR-OPENING TOOLS

Last, but not least, we will discuss car-opening tools. First, let me say that all of the PLT/key outline tracing techniques are applicable to tools that will work non-GM locks. GM locks can only be opened by a snake pick capable of literally lining up all the tumblers simultaneously. Once the shutter over the keyway is bypassed, picking can proceed as usual. It may be useful to secure a couple junk auto locks and grind off the front of the lock, exposing the keyway to allow for easy tool sizing. However, there is a tool that bypasses door locks only. Grind the tool shown in Figure 19 from one-sixteenth inch tempered or spring steel stock. Possible sources are hardware store stock bins, elevator bands, discarded large bandsaw blades, or metal house wind bracing. Please note: this tool is inserted between the outside weather stripping and the glass, directly above the door lock.

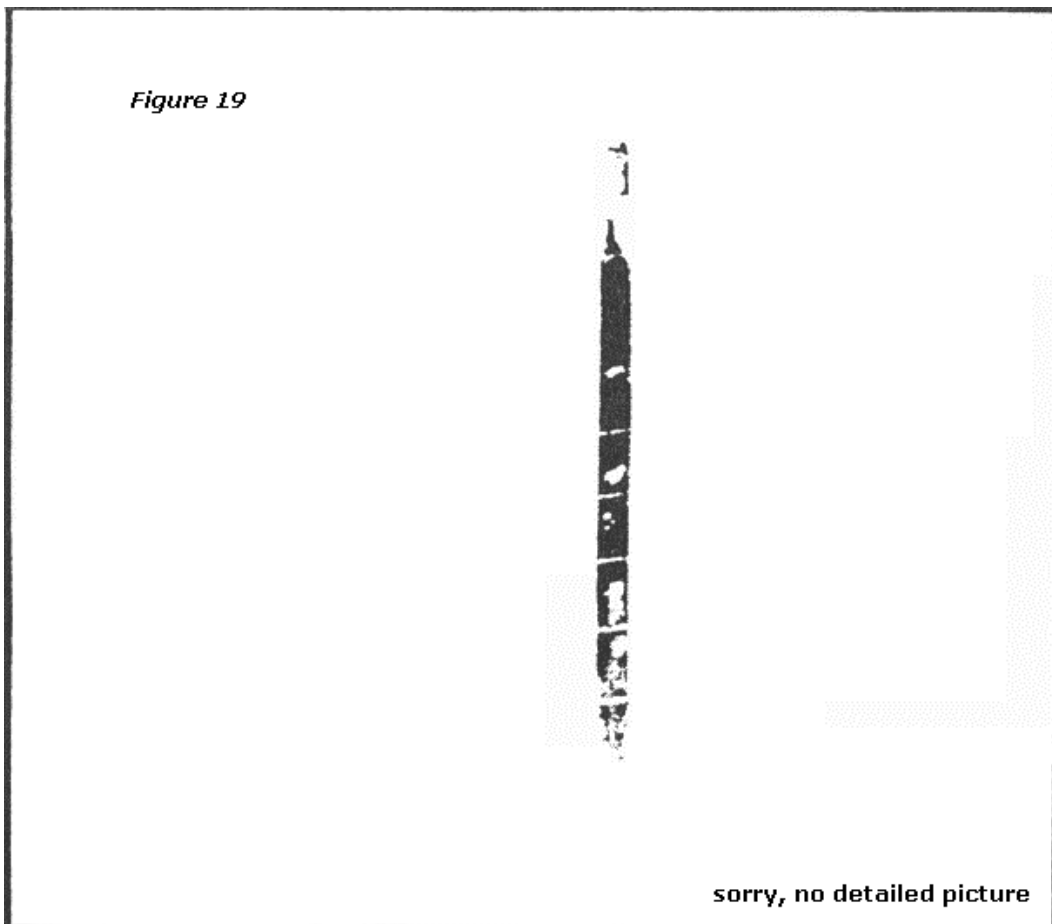

It works by hooking some of the locking mechanism inside the door, either pulling up or pushing down. Also remember occasionally to try to open the door to see if it has been unlocked yet. This tool works on all cars, all years, except Corvettes and 1979 Dodge/Plymouth. These have metal boxes protecting the locking mechanism.

## CARRYING CASES

For carrying cases you can use vinyl business card cases, wallets, wallets with oblong pockets for PLT stitched in, pockets inserted in shoe soles, taped to belts, taped to skin, large hollowed-out pens and other carrying methods. A leather wallet with oblong stitched pockets is easiest. Remember, if it's convenient, you will carry it more often (law permitting) and have it when you need it. An interesting variation, though, is pen-PLT. Buy a small X-acto knife blade and a screw or snap top pen that looks as if it could accommodate the diameter of the X-acto knife handle (remember the handle can be cut very short). Now trace the outline of the blade end onto the front of a PLT handle and cut it out. The PLT shank and tip with its new end should now fit into the X-acto knife holder and prove easy to work. All that remains is to hollow out the pen and shorten the X-acto handle (if necessary) to fit inside. Several different PLT profiles cut with an X-acto end can usually be stored in the pen along with a mini-tension wrench. Another possibility is tracing a PLT onto the blades of a small jackknife, holding a separate tension wrench on with a rubber band. Note that a tension wrench can often be improvised. Individual picks can often be drilled (tough steel, though!) and riveted or bolted into a stack for ease of carrying. The possibilities are endless.

*Figure 20: a PLT set with a "wallet"-type carrying case*

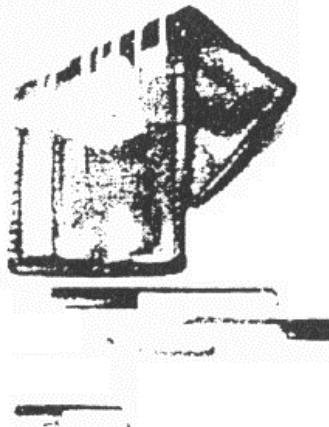

sorry, no detailed picture

## A WORD ON ONE-OFFS

Finally, a brief word on one-offs. Realizing that even a key with nothing but deep cuts will still lift the pins slightly to that lowest cut level, I devised two tools to accomplish that job quickly. The first is a diamond PLT with a delta dimension one-half of the minimum adjacent key cut height you can find. The point of the diamond is barely there, but a few quick rakes with this PLT (again, you should know your lock-picking theory) brings all the pins up a little. The second tool is merely a set of straight shank tools of varying widths with a 45° slope at the end to help it slip under the pins. The tools are inserted one at a time from small to large until the lock core "gives", indicating one or more shear lines have been reached (if you don't know your theory, trust me). From then on, regular tools work the rest of the pins.

---

Well, that just about covers tools, and anyone equipped with the complete set described in this book can bypass 99% of the locks he/she will encounter. At this time, I would like to thank Loompanics Unlimited for their cooperation and support. If you like this work, write in and say so.



***Many more books on lock-picking and related Subjects are available from Loompanics Unlimited. Please see the catalog announcement on the next page.***