

# INSPIRE 1 PRO

User Manual V1.4

2017.12

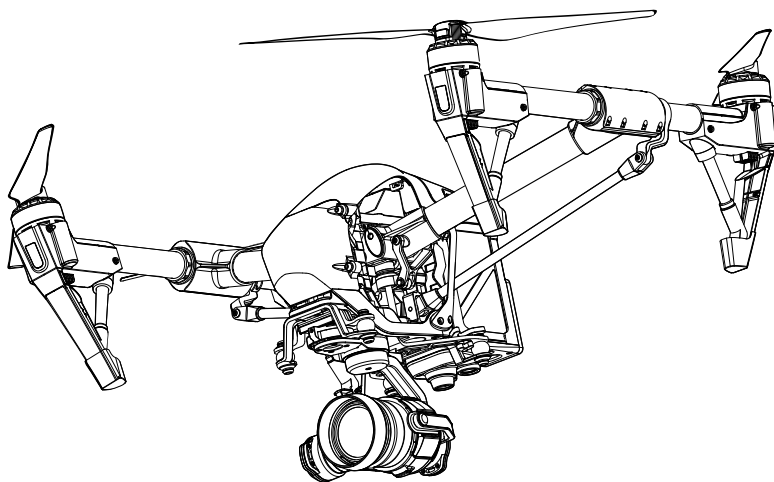

## Searching for Keywords

Search for keywords such as “battery” and “install” to find a topic. If you are using Adobe Acrobat Reader to read this document, press Ctrl+F on Windows or Command+F on Mac to begin a search.

## Navigating to a Topic

View a complete list of topics in the table of contents. Click on a topic to navigate to that section.

## Printing this Document

This document supports high resolution printing.

# Using this manual

## Legends

 Warning

 Important

 Hints and Tips

 Reference

## Before Flight

The following tutorials and manuals have been produced to ensure you to make full use of your Inspire 1 Pro.

1. In the Box
2. Safety Guidelines and Disclaimer
3. Quick Start Guide
4. Intelligent Flight Battery Safety Guidelines
5. User Manual

Watching all the tutorial videos and reading the Disclaimer before flight is recommended. Afterwards, prepare for your first flight by using the Quick Start Guide. Refer to this manual for more comprehensive information.

## Watch the video tutorials

Please watch the tutorial video below to learn how to use Inspire 1 Pro correctly and safely:

<http://www.dji.com/product/inspire-1-pro-and-raw/video>



## Download the DJI GO app

Be sure to use the DJI GO app or other apps compatible with DJI aircraft during flight.

Scan the QR code or visit

“<http://m.dji.net/djigo>” to download the app.



For the best experience, use mobile device with Android V 4.1.2 or above. Requires iOS 8.0 or later.

For increased safety, the flight is restricted to a height of 30 m and distance of 50 m when not connected or logged into the app during flight, including DJI GO and all apps compatible with DJI aircraft.

# Contents

<b>Using this manual</b>	2
Legends	2
Before Flight	2
Watch the video tutorials	2
Download the DJI GO app	2
<b>Product Profile</b>	5
Introduction	6
Feature Highlights	6
Assemble the Aircraft	6
Installing the Gimbal and Camera	7
Aircraft Diagram	11
Remote Controller Diagram	11
<b>Aircraft</b>	13
Flight Controller	14
Flight Mode	14
Flight Status Indicator	14
Return to Home (RTH)	15
Dynamic Home Point	17
Vision Positioning System	18
Flight Recorder	20
Attaching and Detaching the Propellers	20
DJI Intelligent Flight Battery	20
<b>Remote Controllers</b>	25
Remote Controller Profile	26
Remote Controller Operations	26
Dual Remote Controllers Mode	31
Remote Controller Status LED	33
Linking the Remote Controller	34
Remote Controller Compliance Version	36
Used with the DJI Focus	36

<b>Gimbal and Camera</b>	37
Camera Profile	38
Status LED	39
Gimbal	40
<b>DJI GO App</b>	43
Camera	44
Library	48
Explore	48
Me	48
<b>Flight</b>	49
Flight Environment Requirements	50
Flight Limits and Flight Restriction Area	50
Preflight Checklist	54
Calibrating the Compass	54
Auto Take-off and Auto Landing	55
Flight Test	56
Starting/Stopping the Motors	56
<b>FAQ</b>	58
<b>Appendix</b>	61
Specifications	62
Intelligent Flight	66
How to Update Firmware	66



# Product Profile

---

This chapter describes the features of Inspire 1 Pro, instructs you to assemble the aircraft and explains the components on the aircraft and remote controllers.

# Product Profile

## Introduction

The Inspire 1 Pro is brand new quadcopter capable of capturing 4K video and transmitting an HD video signal (up to 5km) to multiple devices straight out of the box. Equipped with retractable landing gear, it can capture an unobstructed 360 degree view from its camera. The built-in camera has an integrated gimbal to maximize stability and weight efficiency while minimizing space. When no GPS signal is available, Vision Positioning technology provides hovering precision.

## Feature Highlights

The Inspire 1 Pro is a professional aerial filmmaking and photography platform that is ready to fly right out of the box. Featuring an onboard camera equipped with a 15mm f/1.7 (35 mm format equivalent 30 mm) lens and 3-axis stabilized gimbal, it shoots sharp 16mp stills and stable video at up to 4K. Its retractable landing gear pulls up out of view, giving the camera an unobstructed 360 degree view of the world below.

**HD Video Downlink:** Low latency, HD downlink powered by an enhanced version of the DJI Lightbridge system. It also provides dual controllers mode.

**Landing gear:** Retractable landing gear that enables an unobstructed panoramic view from the camera.

**DJI Intelligent Flight Battery:** 4500 mAh DJI Intelligent Flight Battery employs new battery cells and a battery management system.

**Flight Controller:** The next generation flight controller system provides a more reliable flight experience. A new flight recorder stores the flight data from each flight, and Vision Positioning enhances hovering precision when no GPS is available.

## Assemble the Aircraft

### Unlocking Travel Mode

The aircraft is in Travel Mode during delivery. Follow these steps to change it to Landing Mode before your first flight:

1. Insert the Intelligent Flight Battery into the battery compartment.
2. Power on the Remote Controller and the Intelligent Flight Battery.
3. Toggle the Transformation Switch up and down at least four times.
4. Power off the aircraft.

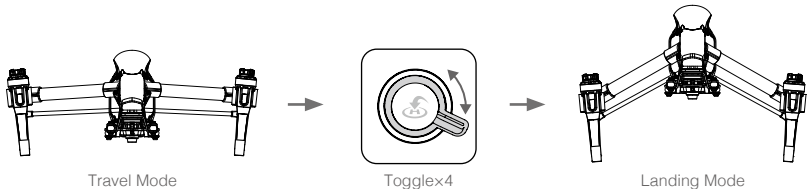

- ⚠ • Battery must be fully charged before using it for the first time. Refer to "Charging the Intelligent Flight Battery" (P23) for more information .
- If you have purchased the dual remote controller version, you must use the primary remote controller to deactivate Travel Mode. Refer to "Setting Up Dual Remote Controllers Mode" (P32) section for more information about primary remote controller.
- Be sure to remove the gimbal from the aircraft before switch from Landing Mode to Travel Mode.
- Place the aircraft on the smooth and reflective surface (e.g. table or tile) before switching between the travel modes to the landing mode. Do not place the aircraft on the rough and sound-absorbing surface (e.g. carpet) before switching between the travel modes and landing mode.

## Installing the Gimbal and Camera

The following steps use the DJI MFT 15mm f/1.7 ASPH as illustration of how to mount the camera lens to the camera body. Be sure to power off the battery before installation.

1. Remove the camera body cap.
2. While holding down the Lens Release Button, rotate the Lens Lock clockwise to unlock it.
3. Remove the lens cap and rear cap.

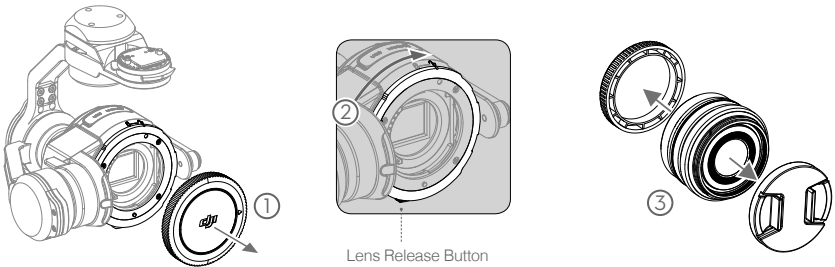

- ⚠ The Zenmuse X5 currently supports the following lenses, and will continue to support more lenses in the future.

DJI MFT 15mm f/1.7 ASPH

Panasonic Lumix G Leica DG Summilux 15mm f/1.7 ASPH

Olympus M.Zuiko Digital ED 12mm f/2.0

Olympus M.Zuiko Digital ED 17mm f/1.8

Olympus M.Zuiko Digital ED 25mm f/1.8

Olympus M.Zuiko Digital ED 45mm f/1.8 (For still photography)

Olympus M.Zuiko Digital ED 14-42mm f/3.5-5.6 EZ (For still photography)

4. Align the two Lens Mount Indexes on the camera body and camera lens, and insert the camera lens into the body of the camera.
5. Rotate the camera lens clockwise until you hear a click.
6. Rotate the Lens Lock counterclockwise to lock it.
7. Mount the Balancing Ring (or a filter) and the Lens Hood.
8. Insert the Micro SD card.

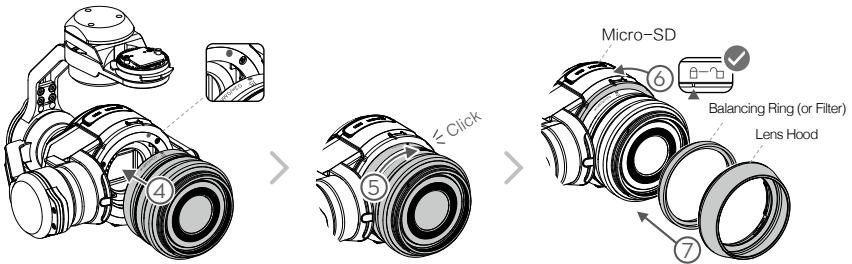

To remove the camera lens, power off the battery and then:

1. While holding down the Lens Release Button, rotate the Lens Lock clockwise to unlock it.
2. While holding down the Lens Release Button, rotate the camera lens counterclockwise to detach it.

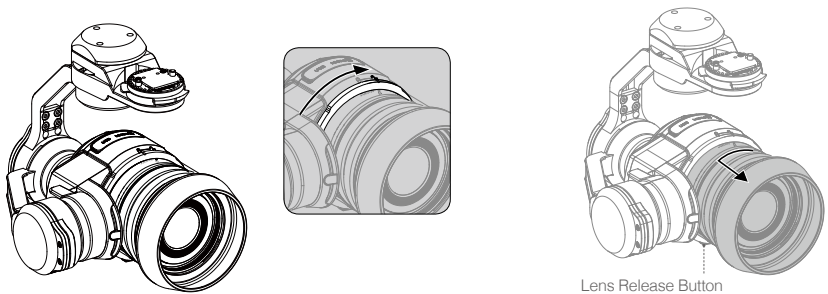

- It is recommended to wrap a dust cover around the lens to prevent contamination. DJI produces dedicated dust covers for the DJI MFT 15mm f/1.7 ASPH and the Panasonic Lumix G Leica DG Summilux 15mm f/1.7 ASPH. Other lenses may require you to purchase a third-party dust cover.
- It is important to tighten the Lens Lock after attaching the camera lens, as this can reduce the vibrations of the lens when the aircraft is moving in flight. Always loosen the Lens Lock before attaching and detaching the camera lens.
- A filter can be installed in place of the Camera Balancing Ring. Remember to use a filter that fulfills the weight requirement.
- Some lenses must not be used with a lens hood. Be sure to check the table above for accessory requirements for your lens.
- Be sure to set the lens to AF mode.
- Always hold down the Lens Release Button before rotating the Lens Lock to unlock it.

- ☀️ Filters must have a weigh 7 - 11 g, with those weighing 10 - 11 g performing the best. Outside this range, the filter will decrease gimbal performance. DJI MFT 15mm f/1.7 ASPH supports filters have a size of 46mm. The Balancing Ring must be installed on the camera lens when a filter is not used.

### Attach the Zenmuse X5

Ensure to power off the aircraft.

1. Rotate the Gimbal Lock to the unlocked position.
2. Align the key on the damping plate with the slot on the gimbal's pan motor.
3. While aligning the white lines on the Gimbal Connector and Gimbal Lock, insert the Gimbal Connector.
4. Rotate the Gimbal Lock to the locked position.

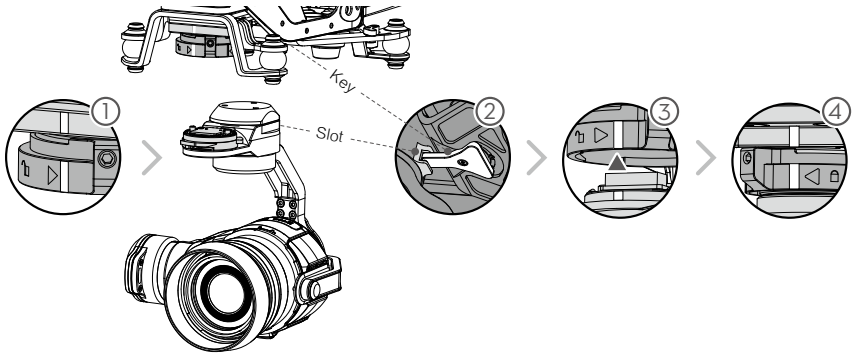

- ⚠️ Be careful not to damage the Gimbal Connector and its metal contacts when attaching or storing the Zenmuse X5.

### Attaching 1345T Quick-Release Propellers

Following the steps below to attach the 1345T Quick-Release propellers.

1. Pair the propellers and motors with arrows of the same color (red or white).

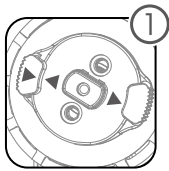
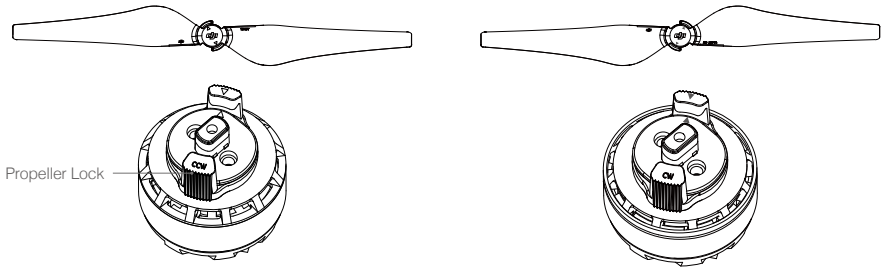

Rotate the propeller lock until the arrows are aligned and you hear a click.

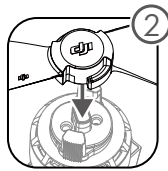

Attach the propeller onto the motor.

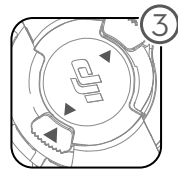

Once again, rotate the propeller lock until you hear a click.

### Preparing Remote Controller

Tilt the Mobile Device Holder to the desired position then adjust the antenna as shown.

1. Press the button on the side of the Mobile Device Holder to release the clamp, adjust it to fit then attach your mobile device.
2. Connect your mobile device to the remote controller with a USB cable.
3. Plug one end of the cable into your mobile device, and the other end into the USB port on the back of the remote controller.

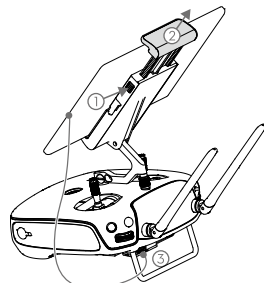
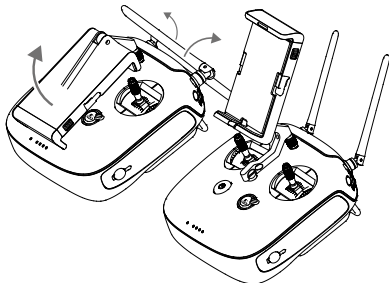

## Aircraft Diagram

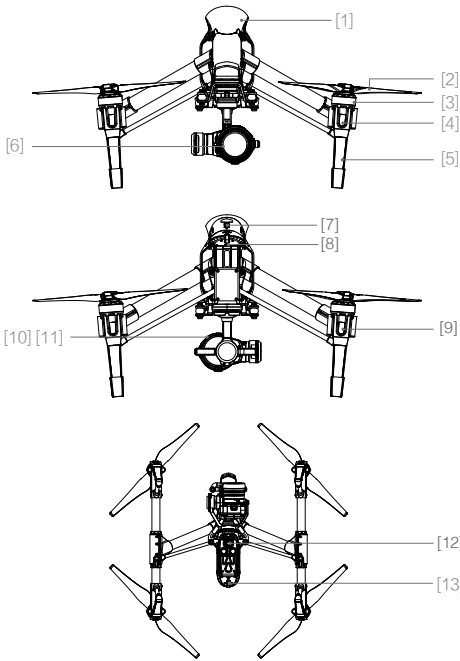

- [1] GPS
- [2] Propeller (P20)
- [3] Motor
- [4] Front LED (P14)
- [5] Landing gear
- [6] Gimbal and Camera (P37)
- [7] Intelligent Flight Battery (P20)
- [8] Aircraft Micro-USB Port
- [9] Rear LED (P14)
- [10] Camera Micro-USB Port
- [11] Camera Micro-SD Card Slot (P38)
- [12] Vision Positioning Sensors (P18)
- [13] Aircraft Status Indicator (P15)

## Remote Controller Diagram

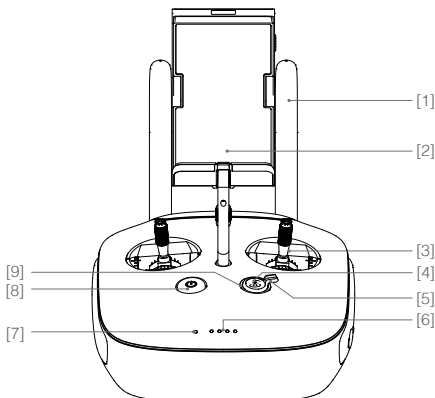

- [1] **Antennas (P31)**  
Relays aircraft control and video signal.
- [2] **Mobile Device Holder**  
Mounting place for your mobile device.
- [3] **Control Stick**  
Controls aircraft orientation.
- [4] **Return Home (RTH) Button (P15)**  
Press and hold the button to initiate Return to Home (RTH).
- [5] **Transformation Switch (P29)**  
Toggle the switch up or down to raise or lower the landing gear.

**[6] Battery Level LEDs**

Displays the current battery level.

**[7] Status LED**

Displays the power status.

**[8] Power Button**

Used to power on or power off the remote controller.

**[9] RTH LED**

Circular LED around the RTH button displays RTH status.

**[10] Camera Settings Dial**

Turn the dial to adjust camera settings. Only functions when the remote controller is connected to a mobile device running the DJI GO app.

**[11] Playback Button**

Playback the captured images or videos.

**[12] Shutter Button**

Press to take a photo. If in burst mode, the set number of photos will be taken with one press.

**[13] Flight Mode Switch**

Used to switch between P, A and F mode.

**[14] Video Recording Button**

Press to start recording video. Press again to stop recording.

**[15] Gimbal Dial**

Use this dial to control the tilt of the gimbal.

**[16] Mini-HDMI Port**

Connect an HD compatible monitor to this port to get a live HD video preview of what the camera sees.

**[17] Micro-USB Port**

For connecting the remote controller to your computer.

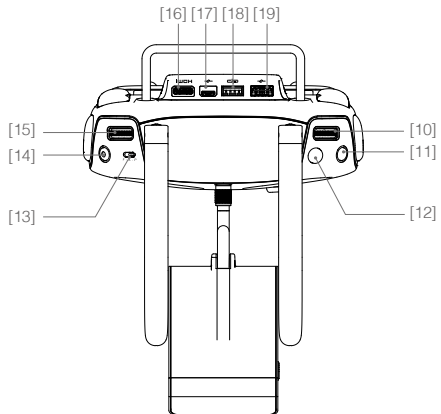

**[18] CAN Bus Port**

Reserved for future use.

**[19] USB Port**

Connect to mobile device to access all of the DJI GO app controls and features.

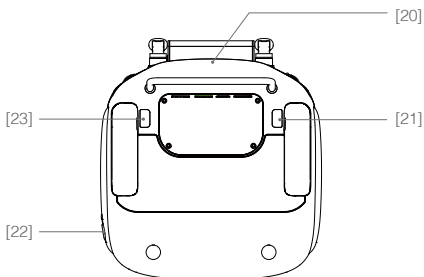

**[20] GPS Module**

Used to pinpoint the location of the remote controller.

**[21] Back Left Button**

Customizable button in DJI GO app.

**[22] Power Port**

Connect to a power source to charge the remote controller's internal battery.

**[23] Back Right Button**

Customizable button in DJI GO app.



# Aircraft

---

This chapter describes the features of the Flight Controller, Vision Positioning System and the Intelligent Flight Battery.

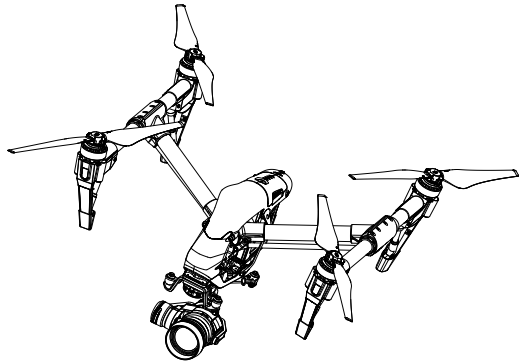

# Aircraft

## Flight Controller

The Inspire 1 Pro's flight controller is based on DJI flight controller with several enhancements such as new flight mode and new safe mode. Three safe modes are available: Failsafe, Return Home and Dynamic Home Point. These features ensure the safe return of your aircraft if the control signal is lost. A flight recorder stores crucial flight data for each flight.

## Flight Mode

Three flight modes are available. The details of each flight mode are found in the section below:

**P mode (Positioning)** : P mode works best when GPS signal is strong. There are three different states of P mode, which will be automatically selected by the Inspire 1 Pro depending on GPS signal strength and Vision Positioning sensors:

P-GPS: GPS and Vision Positioning both are available, and the aircraft is using GPS for positioning.

P-OPTI: Vision Positioning is available but the GPS signal is not. Aircraft is using only Vision Positioning for hovering

P-ATTI: Neither GPS or Vision Positioning available, aircraft is using only its barometer for positioning, so only altitude is controlled.

**A mode (Attitude)**: The GPS and Vision Positioning System is not used for holding position. The aircraft only uses its barometer to maintain altitude. If it is still receiving a GPS signal, the aircraft can automatically return home if the Remote Controller signal is lost and if the Home Point has been recorded successfully.

**F mode (Function)**: Intelligent Orientation Control (IOC) is activated in this mode. For more information about IOC, refer to the IOC in Appendix.



Use the Flight Controller mode switch to change the flight mode of the aircraft, refer to the "Flight Mode Switch" on P29 for more information.

## Flight Status Indicator

The Inspire 1 Pro comes with the Front LED, Rear LED and Aircraft Status Indicator. The positions of these LEDs are shown in the figure below:

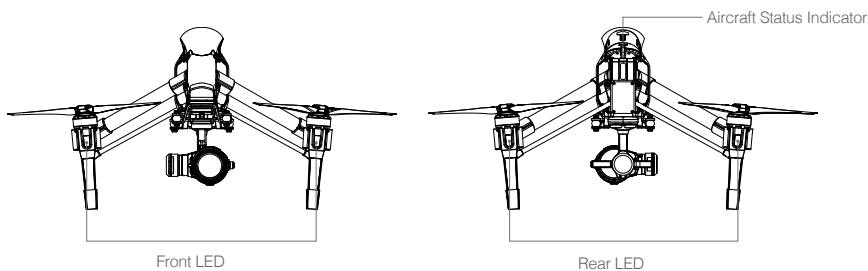





The Front and Rear LED show the orientation of the aircraft. The Front LED displays solid red and the Rear LED displays solid green.







Aircraft Status Indicator shows the system status of the flight controller. Refer to the table below for more information about the Aircraft Status Indicator:

## Aircraft Status Indicator Description

### Normal



 ..... Red, Green and Yellow Flash Alternately	Power on and self-check
 ..... Green and Yellow Flash Alternately	Aircraft warming up
 ..... Green Flashes Slowly	Safe to Fly (P mode with GPS and Vision Positioning)
 X2 ..... Green Flashes Twice	Safe to Fly (P mode with Vision Positioning but without GPS)
 ..... Yellow Flashes Slowly	Safe to Fly (A mode but No GPS and Vision Positioning)

### Warning

 ..... Fast Yellow Flashing	Remote Controller Signal Lost
 ..... Slow Red Flashing	Low Battery Warning
 ..... Fast Red Flashing	Critical Low Battery Warning
 ..... Red Flashing Alternately	IMU Error
 — Solid Red	Critical Error
 ..... Red and Yellow Flash Alternately	Compass Calibration Required

## Return to Home (RTH)

The Return to Home (RTH) brings the aircraft back to the last recorded Home Point. There are three cases that will trigger RTH procedure; they are Smart RTH, Low Battery RTH and Failsafe RTH.

	GPS	Description
Home Point		The Home Point is the location at which your aircraft takes off when the GPS signal is strong. You can view the GPS signal strength through the GPS icon (  ). If you are using the Dynamic Home Point setting, the Home Point will be updated to your current position as you move around and when the Aircraft Status Indicator blinks green.

### Smart RTH

Using the RTH button on the remote controller (refer to “RTH button” on P30 for more information) or the RTH button in the DJI GO app when GPS is available to enables smart RTH. The aircraft return to the latest recorded Home Point, you may control the aircraft’s orientation to avoid collision during the Smart RTH. Press the Smart RTH button once to start the process, press the Smart RTH button again to exit Smart RTH and regain the control.

## Low Battery RTH

The low battery level failsafe is triggered when the DJI Intelligent Flight Battery is depleted to a point that may affect the safe return of the aircraft. Users are advised to return home or land the aircraft immediately when these warnings are shown. DJI GO app will advise user to return the aircraft to the Home Point when low battery warning is triggered. Aircraft will automatically return to the Home Point if no action is taken after 10 seconds countdown. User can cancel the RTH by pressing once on the RTH button. The thresholds for these warnings are automatically determined based on the current aircraft altitude and its distance from the Home Point.

Aircraft will land automatically if the current battery level can only support the aircraft to land to the ground from the current altitude. User can use the remote controller to control the aircraft's orientation during the landing process.

The Battery Level Indicator is displayed in the DJI GO app, and is described below

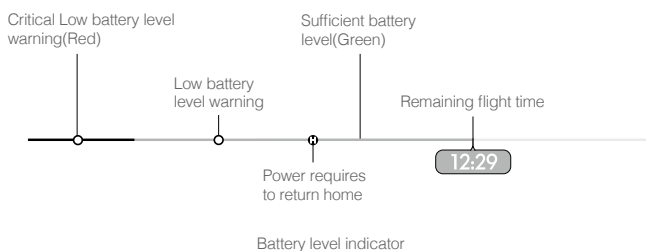

Battery Level Warning	Remark	Aircraft Status Indicator	DJI GO app	Flight Instructions
Low battery level warning	The battery power is low. Please land the aircraft.	Aircraft status indicator blinks RED slowly.	Tap "Go-home" to have the aircraft return to the Home point and land automatically, or "Cancel" to resume normal flight. If no action is taken, the aircraft will automatically go home and land after 10 seconds. Remote controller will sound an alarm.	Fly the aircraft back and land it as soon as possible, then stop the motors and replace the battery.
Critical Low battery level warning	The aircraft must land immediately.	Aircraft status indicator blinks RED quickly.	The DJI GO app screen will flash red and aircraft starts to descend. Remote controller will sound an alarm.	The aircraft will begin to descend and land automatically.
Estimated remaining flight time	Estimated remaining flight based on current battery level.	N/A	N/A	N/A

- ☀️ • When the critical battery level warning activates and the aircraft is descending to land automatically, you may push the throttle upward to hover the aircraft and navigate it to a more appropriate location for landing.
- Color zones and markers on the battery level indicator reflect estimated remaining flight time and are adjusted automatically, according to the aircraft's current status.

## Failsafe RTH

Failsafe RTH is activated automatically if remote controller signal (including video relay signal) is lost for more than 3 seconds provided that Home Point has been successfully recorded and compass is working normally. Return home process may be interrupted and the operator can regain control over the aircraft if a remote controller signal is resumed.

## Failsafe Illustration

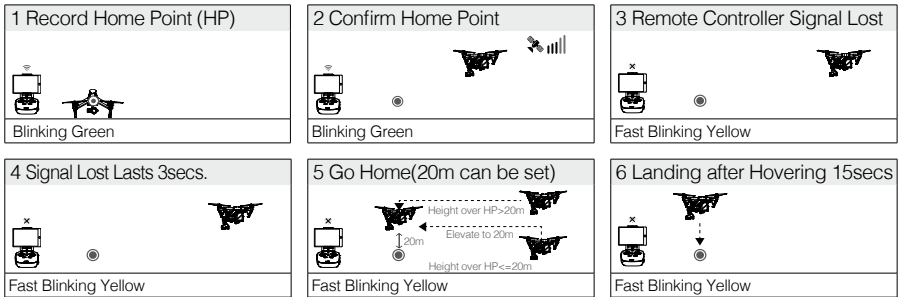

- ⚠️ • Aircraft automatically descends and lands if RTH is triggered when the aircraft flies within a 20 meter (65 feet) radius of the Home Point.
- Aircraft cannot avoid obstruction during the Failsafe RTH, therefore it is important to set an reasonable Failsafe altitude before each flight. Launch the DJI GO app and enter "Camera" view and select "MODE" to set the Failsafe altitude.
- Aircraft will stop ascending and immediately return to the Home Point if you move the throttle stick if the aircraft reaches 20 m altitudes or beyond during Failsafe.

## Dynamic Home Point

Dynamic home point is useful in situations when you are in motion and require a Home Point that is different from the takeoff point. GPS module is located at the position shown in the figure below:

- ⚠️ Ensure the space above the GPS module is not obstructed when using Dynamic Home Point.

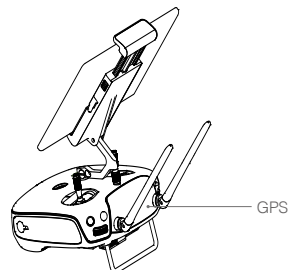

There are two options for Dynamic Home Point.

1. Set the aircraft current coordinate as the new Home Point.
2. Set the remote controller's coordinate as the new Home Point.

### Setting Up Dynamic Home Point

Follow the steps below to setup Dynamic Home Point:

1. Connect to the mobile device and launch the DJI GO app and go to the "Camera" page.
2. Tap "📍" and select "🏠", to reset the remote controller's coordinates as the new Home Point.
3. Tap "📍" and select "🚁", to reset the aircraft's coordinates as the new Home Point.
4. The aircraft status indicator blinks green to show Home Point is set successfully.

## Vision Positioning System

DJI Vision Positioning is a positioning system that uses ultrasonic and image data to help the aircraft identify its current position. With the help of Vision Positioning, your Inspire 1 Pro can hover in place more precisely and fly indoors or in other environments where there is no GPS signal available. The main components of DJI Vision Positioning are located on the bottom of your Inspire 1 Pro, including [1]two sonar sensors and [2]one monocular camera.

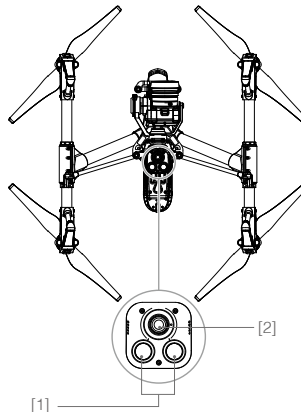

### Using Vision Positioning

Vision Positioning is activated automatically when the Inspire 1 Pro is powered on. No manual action is required. Vision Positioning is typically used in the indoor environment where no GPS is available. By using the sensors on the Vision Positioning system, Inspire 1 Pro can perform precision hovering even when no GPS is available.

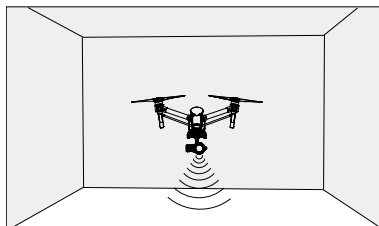

Follow the steps below to use Vision Positioning:

1. Toggle the switch to "P" as shown the figure to the right:
2. Place the Inspire 1 Pro on a flat surface. Notice that the Vision Positioning system cannot work properly on surfaces without pattern variations.
3. Power on the Inspire 1 Pro. The aircraft status indicator will flash twice in green light, which indicates the Vision Positioning system is ready. Gently push the throttle up to lift off, and the Inspire 1 Pro will hover in place.

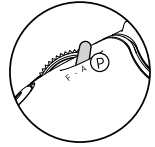

The performance of your Inspire 1 Pro's Vision Positioning System is subject to the surface you are flying over. The ultrasonic waves may not be able to accurately measure the distance over sound absorbing materials, and the camera may not function correctly in suboptimal environments. The aircraft will switch from "P" mode to "A" mode automatically if both GPS and Vision Positioning System are not available. So operate the aircraft cautiously when in any of the following situations:

- Flying over monochrome surfaces (e.g. pure black, pure white, pure red, pure green).
- Flying over a highly reflective surfaces.
- Flying at high speeds (over 8m/s at 2 meters or over 4m/s at 1 meter).
- Flying over water or transparent surfaces.
- Flying over moving surfaces or objects.
- Flying in an area where the lighting changes frequently or drastically.
- Flying over extremely dark (lux < 10) or bright (lux > 10,000) surfaces.
- Flying over surfaces that can absorb sound waves (e.g. thick carpet).
- Flying over surfaces without clear patterns or texture.
- Flying over surfaces with identical repeating patterns or textures (e.g. tiles with same design).
- Flying over inclined surfaces that will deflect sound waves away from the aircraft.
- In the event of loss of remote controller's signal, the aircraft will hover for 8 seconds and then auto-land if it is in "P" mode.



- Keep the sensors clean at all times. Dirt or other debris may adversely affect the effectiveness of the sensors.
- The effective hovering altitudes of the aircraft is from 0 to 2.5 meters.
- Vision Positioning system may not function properly when the aircraft is flying over water.
- Vision Positioning system may not be able to recognize pattern on the ground in low light conditions (less than 100lux).
- Do not use other ultrasonic devices with frequency of 40 KHz when Vision Positioning system is in operation.
- Vision Positioning system may not be able to stabilize the aircraft when flying close to the ground (below 0.5 meters) in fast speed.



Keep the animals away from the aircraft when Vision Positioning system is activated. The sonar sensor emits high frequency sound that is only audible to some animals.

## Flight Recorder

Flight data is automatically stored in the internal storage device of the aircraft. User can gain access to these data through the DJI GO app. This includes flight duration, orientation, distance, aircraft status information, speed, and other parameters.

## Attaching and Detaching the Propellers

### Attaching the Propellers

Refer to "Attaching Propellers" on p10 for details.

### Detaching the Propellers

Release the propeller lock and remove the propeller.

- 
- ⚠ • Check that the propellers and motors are installed correctly and firmly before every flight.
  - Ensure that all propellers are in good condition before each flight. DO NOT use old, chipped, or broken propellers.
  - To avoid injury, STAND CLEAR of and DO NOT touch propellers or motors when they are spinning.
  - ONLY use original DJI propellers for a better and safer flight experience.
- 

## DJI Intelligent Flight Battery

The DJI Intelligent Flight Battery has a capacity of 4500mAh, voltage of 22.2V, and smart charge-discharge functionality. It can only be charged with an appropriate DJI approved charger.

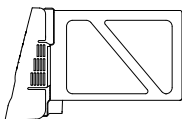

Intelligent Flight Battery

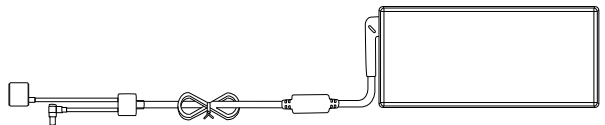

Charger

- 
- ⚠ Battery must be fully charged before using it for the first time. Refer to "Charging the Intelligent Flight Battery" P23 for more information.
-



## DJI Intelligent Flight Battery Functions

1. Battery Level Display: LEDs display the current battery level.
2. Battery Life Display: LEDs display the current battery power cycle.
3. Auto-discharging Function: The battery automatically discharges to below 65% of total power when it is idle (press the power button to check battery level will cause battery to exit idle state) for more than 10 days to prevent swelling. It takes around 2 days to discharge the battery to 65%. It is normal to feel moderate heat emitting from the battery during the discharge process. Discharge thresholds can be set in the DJI GO app.
4. Balanced Charging: Automatically balances the voltage of each battery cell when charging.
5. Over charge Protection: Charging automatically stops when the battery is fully charged.
6. Temperature Detection: The battery will only charge when the temperature is between 5 °C (41°F) and 40°C (104°F).
7. Over Current Protection: Battery stops charging when high amperage (more than 10A) is detected.
8. Over Discharge Protection: Discharging automatically stops when the battery voltage reaches 18V to prevent over-discharge damage
9. Short Circuit Protection: Automatically cuts the power supply when a short circuit is detected.
10. Battery Cell Damages Protection: DJI GO app shows warning message when damaged battery cell is detected.
11. Battery Information History: Show the last 32 entries of battery information records that include warning messages and so on.
12. Sleep Mode: Sleep mode is entered after 10 minutes of inactivity to save power.
13. Communication: Battery voltage, capacity, current, and other relevant information is provided to the aircraft's to the main controller.

 Refer to *Disclaimer* and *Intelligent Flight Battery Safety Guidelines* before use. Users take full responsibility for all operations and usage.

## Using the Battery

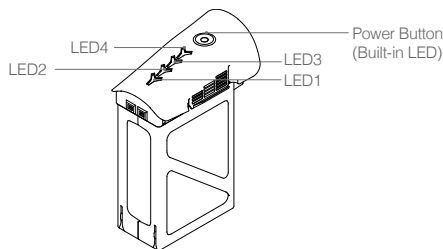

### Powering ON/OFF

**Powering On:** Press the Power Button once, then press again and hold for 2 seconds to power on. The Power LED will turn red and the Battery Level Indicators will display the current battery level.

**Powering Off:** Press the Power Button once, then press again and hold for 2 seconds to power off.

### Low Temperature Notice:

1. The performance of the intelligent Flight Battery is significantly reduced when flying in a low temperature environments (those with air temperatures below 5°C). Ensure that the battery is fully charged and the cell voltage is at 4.35 V before each flight.

- Using the Intelligent Flight Battery in extremely low temperature environments (those with air temperatures below  $-10^{\circ}\text{C}$ ) is not recommended. When flying in environments with temperatures between  $5^{\circ}\text{C}$  and  $-10^{\circ}\text{C}$ , the Intelligent Flight Battery should be able to achieve the appropriate voltage levels (above 4.2 V), but it is recommended that you apply the included insulation sticker to the battery in order to prevent a rapid drop in temperatures.
- If the DJI GO app displays the "Critical Low Battery Level Warning" when flying in low temperature environments, stop flying and land the aircraft immediately. You will still be able to control the aircraft's movement when this warning is triggered.
- Store the Intelligent Flight Battery in a room temperature environment and ensure that its temperature exceeds  $5^{\circ}\text{C}$  before using it in the low temperature environment.
- When using the Inspire 1 Pro in a low temperature environment, begin by allowing the aircraft to hover at a low altitude, for approximately one minute, to heat the battery.
- To ensure optimum performance, keep the Intelligent Flight Battery's core temperature above  $20^{\circ}\text{C}$  when in use.

 In cold environments, insert the battery into the battery compartment and allow the aircraft to warm up for approximately 1-2 minutes before taking off.

### Checking the battery level





































The Battery Level Indicators display how much remaining power the battery has. When the battery is powered off, press the Power Button once. The Battery Level Indicators will light up to display the current battery level. See below for details.

 The Battery Level Indicators will also show the current battery level during charging and discharging. The indicators are defined below.

 : LED is on.

 : LED is flashing.

 : LED is off.

Battery Level				
LED1	LED2	LED3	LED4	Battery Level
				87.5%~100%
				75%~87.5%
				62.5%~75%
				50%~62.5%
				37.5%~50%
				25%~37.5%
				12.5%~25%
				0%~12.5%
				=0%

### Battery life

The battery life indicates how many more times the battery can be discharged and recharged before it must be replaced. When the battery is powered off, press and hold the Power Button for 5 seconds

to check the battery life. The Battery Level Indicators will light up and/or blink as described below for 2 seconds:

Battery Life				
LED1	LED2	LED3	LED4	Battery Life
☹	☹	☹	☹	90%~100%
☹	☹	☹	☹☹	80%~90%
☹	☹	☹	☹	70%~80%
☹	☹	☹☹	☹	60%~70%
☹	☹	☹	☹	50%~60%
☹	☹☹	☹	☹	40%~50%
☹	☹	☹	☹	30%~40%
☹☹	☹	☹	☹	20%~30%
☹	☹	☹	☹	below 20%

⚠ When battery life reaches 0%, it can no longer be used.

📖 For more information about the battery, launch DJI GO app and check the information under the battery tab.

### Charging the Intelligent Flight Battery

1. Connect Battery Charger to a power source (100-240V 50/60Hz).
2. Open the Protection Cap and connect the Intelligent Flight Battery to the Battery Charger. If the battery level is above 95%, turn on the battery before charging.
3. The Battery Level Indicator will display the current battery level during charging.
4. The Intelligent Flight Battery is fully charged when Battery Level Indicators are all off.
5. Air cool the Intelligent Flight Battery after each flight. Allow its temperature to drop to room temperature before storing it for an extended period.

- ⚠
- The charger will stop charging the battery if the battery cell's temperature is not within the operating range (5°C ~ 40°C).
  - Do not charge the Intelligent Flight Battery and remote controller with standard charger (model: A14-100P1A) at the same time, otherwise the charger may overheat.
  - Always turn off the battery before inserting it or removing it from the Inspire 1 Pro. Never insert or remove a battery when it is powered on. The charger will stop charging the battery if the battery cell's temperature is not within the operating range (5°C ~ 40°C).

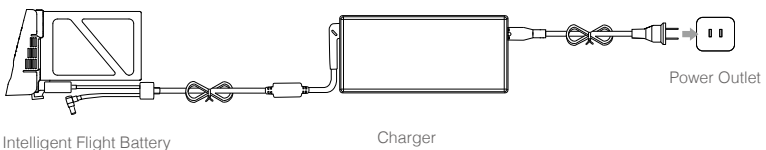

Battery Level Indicators while Charging				
LED1	LED2	LED3	LED4	Battery Level
				0%~25%
				25%~50%
				50%~75%
				75%~100%
				Fully Charged

### Charging Protection LED Display

The table below shows battery protection mechanisms and corresponding LED patterns.

Battery Level Indicators while Charging					
LED1	LED2	LED3	LED4	Blinking Pattern	Battery Protection Item
				LED2 blinks twice per second	Over current detected
				LED2 blinks three times per second	Short circuit detected
				LED3 blinks twice per second	Over charge detected
				LED3 blinks three times per second	Over-voltage charger detected
				LED4 blinks twice per second	Charging temperature is too low (<0°C)
				LED4 blinks three times per second	Charging temperature is too high (>40°C)

After any of the above mentioned protection issues are resolved, press the button to turn off the Battery Level Indicator. Unplug the Intelligent Flight Battery from the charger and plug it back in to resume charging. Note that you do not need to unplug and plug the charger in the event of a room temperature error, the charger will resume charging when the temperature falls within the normal range.

DJI does not take any responsibility for damage caused by third-party chargers.

#### How to discharge your Intelligent Flight Battery:

To effectively calibrate the battery capacity, it is recommended to charge and discharge the battery thoroughly for every 10 charge-and-discharge cycle. User should install the battery onto the aircraft and then power on the aircraft to initiate the discharge process, discharge the battery until the aircraft is powered off automatically. User should then fully charge the battery to ensure the battery is working at its optimal.

**Slow:** Place the Intelligent Flight Battery into the Inspire 1 Pro's Battery Compartment and power it on. Leave it on until there is less than 5% of power left, or until the battery can no longer be turned on. Launch the DJI GO app to check battery level.

**Rapid:** Fly the Inspire 1 Pro outdoors until there is less than 5% of power left, or until the battery can no longer be turned on.

# Remote Controllers

---

This chapter describes the features of the remote controller that includes aircraft and remote controller operations and dual remote controller mode.

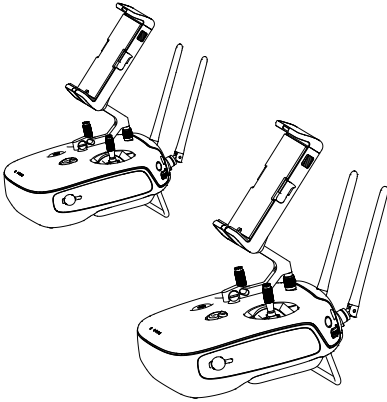

# Remote Controller

## Remote Controller Profile

The Inspire 1 Pro Remote Controller is a multi-function wireless communication device that integrates the video downlink ground system and aircraft Remote Controller system. The video downlink and aircraft Remote Controller system operate at 2.4 GHz with maximum transmission distance of 5km. The remote controller features a number of camera functions, such as taking and previewing photos and video, and controlling gimbal motions. The remote controller is powered by a 2S rechargeable battery. The current battery level is displayed by LEDs on the front panel of the remote control.



- **Compliance Version:** The Remote Controller is compliant with both CE and FCC regulations.
- **Operating Mode:** Control can be set to Mode 1, Mode 2.
- **Mode 1:** The right stick serves as the throttle.
- **Mode 2:** The left stick serves as the throttle.



- Do not operate more than 3 aircrafts within in the same area (size equivalent to a soccer field) to prevent transmission interference.
- To ensure the connection between the aircraft and remote controller, the secondary remote controller is recommended to use in less interference environment.

## Remote Controller Operations

### Powering On And Off The Remote Controller

The Inspire 1 Pro remote controller is powered by a 2S rechargeable battery with a capacity of 6000mAh. The battery level is indicated by the Battery Level LEDs on the front panel. Follow the steps below to power on your remote controller:

1. When powered off, press the Power Button once and the Battery Level LEDs will display the current battery level.
2. Then, press and hold the Power Button to power on the remote controller.
3. The Remote Controller will beep when it powers on. The Status LED will blink green (secondary remote controller blinks solid purple) rapidly, indicating that the remote controller is linking to the aircraft. The Status LED will show a solid green light when linking is completed.
4. Repeat step 2 to power off the remote controller after finish using it.

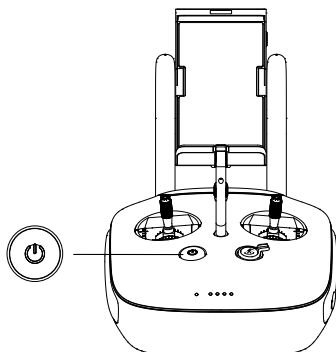

### Charging Remote Controller

Charge the remote controller via supplied charger.

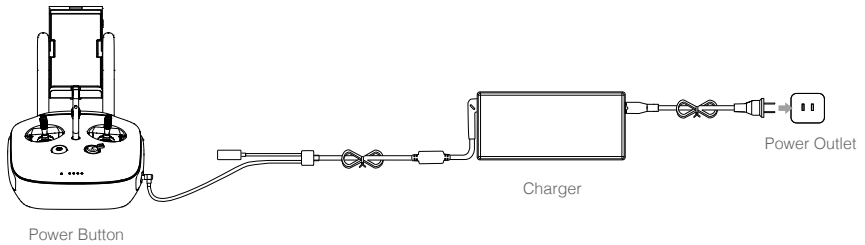

## Controlling Camera

Shoot videos or images and adjust camera settings via the Shutter Button, Camera Settings Dial, Playback Button and Video Recording Button on the remote control.

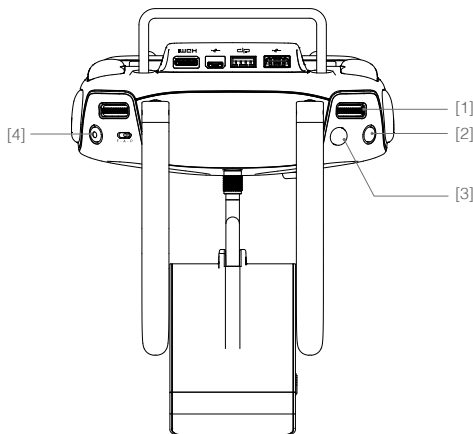

### [1] Camera Settings Dial

Turn the dial to quickly adjust camera settings such as ISO and shutter speed without letting go of the remote controller. Move the dial button to left or right to view the pictures or videos in playback mode.

### [2] Playback Button

Press to view images or videos that have already been captured.

### [3] Shutter Button

Press to take a photo. If burst mode is activated, multiple photos will be taken with a single press.





### [4] Recording Button

Press once to start recording video, then press again to stop recording.

## Controlling Aircraft

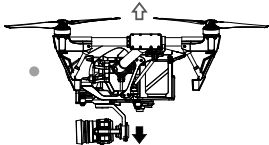
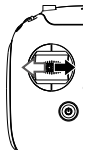
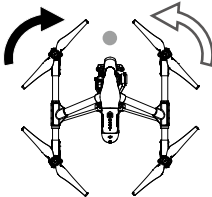
This section explains how to use the various features of the remote controller. The Remote Controller is set to Mode 2 by default.

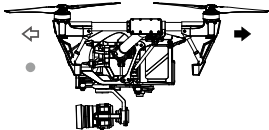

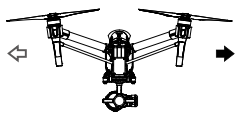
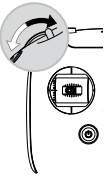
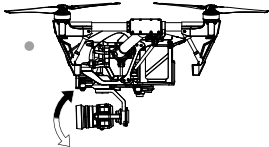
-  Stick Neutral/ mid point: Control sticks of the Remote Controller are placed at the central position.  
 Move the Stick: The control stick is pushed away from the central position.

Remote Controller (Mode 2)	Aircraft (● indicates nose direction)	Remarks
		<p>Moving the left stick up and down changes the aircraft's elevation.</p> <p>Push the stick up to ascend and down to descend.</p> <p>Push the throttle stick up to takeoff.</p> <p>When both sticks are centered, the Inspire 1 Pro will hover in place.</p> <p>The more the stick is pushed away from the center position, the faster the Inspire 1 Pro will change elevation. Always push the stick gently to prevent sudden and unexpected elevation changes.</p>
		<p>Moving the left stick to the left or right controls the rudder and rotation of the aircraft.</p> <p>Push the sick left to rotate the aircraft counter clock-wise, and push the stick right to rotate the aircraft clockwise. If the stick is centered, the Inspire 1 Pro will stay facing its current direction.</p> <p>The more the stick is pushed away from the center position, the faster the Inspire 1 Pro will rotate.</p>
		<p>Moving the right stick up and down changes the aircraft's forward and backward pitch.</p> <p>Push the stick up to fly forward and down to fly backward. The Inspire 1 Pro will hover in place if the stick is centered.</p> <p>Push the stick further away from the center position for a larger pitch angle (maximum 35°) and faster flight.</p>
		<p>Moving the right stick control left and right changes the aircraft's left and right pitch.</p> <p>Push left to fly left and right to fly right. The Inspire 1 Pro will hover in place if the stick is centered.</p> <p>Push the stick further away from the center position for a larger pitch angle (maximum 35°) and faster flight.</p>
		<p>Gimbal Dial: Turn the dial to the right, and the camera will shift to point upwards. Turn the dial to the left, and the camera will shift to point downwards. The camera will remain in its current position when dial is static.</p>



### Flight Mode Switch

Toggle the switch to select the desired flight mode. You may choose between; P mode, F mode and A mode.

Figure	Flight Mode
F 	F mode
A 	A mode
P 	P mode

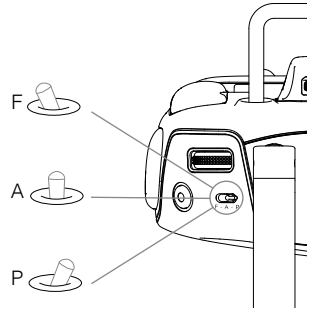

**P mode (Positioning)** : P mode works best when GPS signal is strong. There are three different states of P mode, which will be automatically selected by the Inspire 1 Pro depending on GPS signal strength and Vision Positioning sensors:

**P-GPS**: GPS and Vision Positioning both are available, and the aircraft is using GPS for positioning.

**P-OPTI**: Vision Positioning is available but the GPS signal is not. Aircraft is using only Vision Positioning for hovering

**P-ATTI**: Neither GPS or Vision Positioning available, aircraft is using only its barometer for positioning, so only altitude is controlled.

**A mode (Attitude)**: The GPS and Vision Positioning System is not used for holding position. The aircraft only uses its barometer to maintain altitude. If it is still receiving a GPS signal, the aircraft can automatically return home if the Remote Controller signal is lost and if the Home Point has been recorded successfully.

**F mode (Function)**: Intelligent Orientation Control (IOC) is activated in this mode. For more information about IOC, refer to the IOC in Appendix.

The Flight Mode Switch is locked in P mode by default. To unlock the switch, launch the DJI GO app, enter the "Camera" page, tap "MODE", and then activate "Multiple Flight Mode" .

### Transformation Switch / RTH Button

The Transformation Switch / RTH Button combination serves two functions. Toggle the switch up or down to raise or lower the landing gear. Or, press the button to activate the Return to Home (RTH) procedure.

#### Transformation Switch

This switch has two positions. The effect of toggling the switch to any of these positions is defined below:

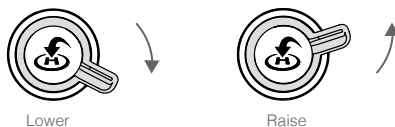

1. **Raise**: Raise the landing gear to its upper most position.

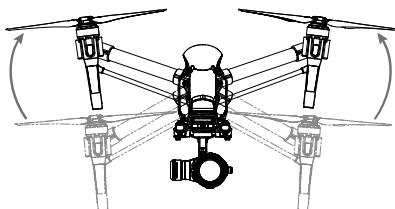

2. **Lower:** The landing gear will lower to its lowest position for landing.

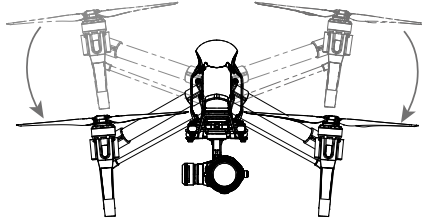

---

 Do not raise the landing gear when the aircraft is on the ground. Ensure the landing gear is lowered before landing.

---

### RTH button

Press and hold this button to start the Return to Home (RTH) procedure. The LED around the RTH Button will blink white to indicate the aircraft is entering RTH mode. The aircraft will then return to the last recorded Home Point. Press this button again to cancel the RTH procedure and regain the control of the aircraft.

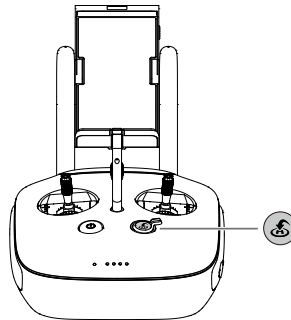

### Connecting Mobile Device

Tilt the Mobile Device Holder to the desired position. Press the button on the side of the Mobile Device Holder to release the clamp, and then place your mobile device into the clamp. Adjust the clamp to secure your mobile device. Then connect your mobile device to the remote controller with a USB cable. Plug one end of the cable into your mobile device, and the other end into the USB port on the back of the remote controller.

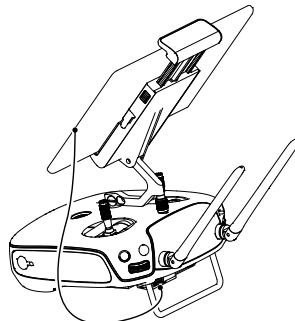

## Optimal Transmission Range

The signal transmission between aircraft and remote controller perform best within the range that displayed in the picture shown below:

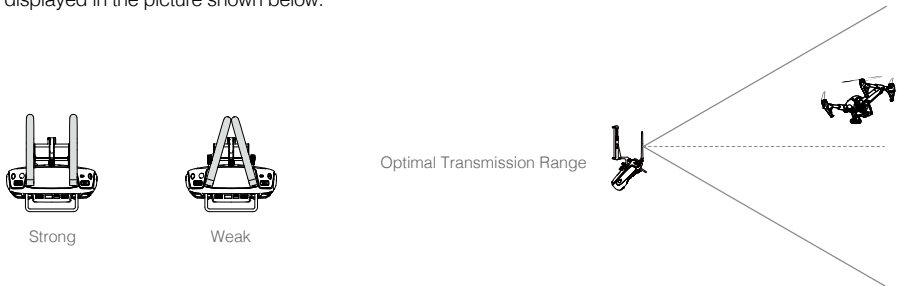

Ensure the aircraft is flying within the optimal transmission range. Adjust the distance and position between the operator and the aircraft to achieve optimal transmission performance.

## Dual Remote Controllers Mode

More than one remote controller can connect to the same aircraft in Dual Remote Controller mode. In Dual Controllers mode, the "Primary" remote controller operator controls the orientation of the aircraft, while the "Secondary" remote controller controls the movement of the gimbal and camera operation. When multiple "secondary" remote controllers (max of 6) are connect to the aircraft, only the first connected "secondary" remote controller is able to control the gimbal, the remaining "secondary" remote controller can view the live feed video from the aircraft and set the camera parameters, but they cannot control the gimbal.

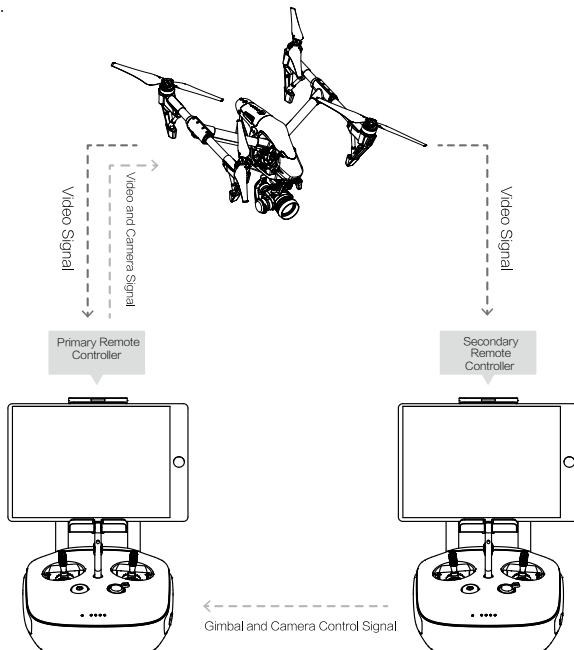

⚠ Use the gimbal dial on the remote controller to control the pitch movement of the camera in the single remote controller mode, however, you cannot control the pan movement of the camera.

### Setting Up Dual Remote Controllers Mode

Dual Remote Controllers mode is disabled by default. Users must enable this feature on the “Primary” remote controller by through the DJI GO app. Follow the steps below for setup:

#### “Primary” Remote Controller:

1. Connect the remote controller to your mobile device and launch the DJI GO app.
2. Go to the Camera page, and tap  to enter the remote controller settings window.
3. Tap “Set RC Status” to enable Primary-and-Secondary mode.
4. Select “Primary” in the “Set RC Status” section to set the remote controller as “Primary” remote controller.

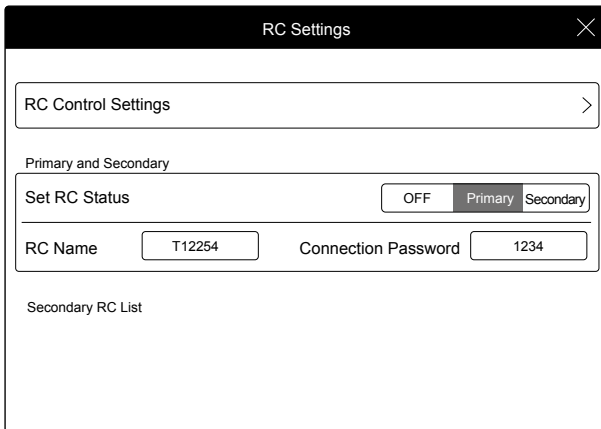

5. Enter the connection password for the “Secondary” remote controller.

#### “Secondary” Remote Controller:

1. Tap “Search for Primary Controller” to search the “Primary” remote controller.

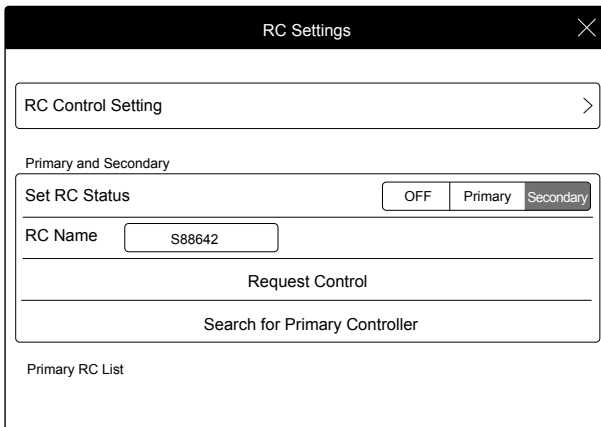

- ⚠ Remote controller cannot link to the aircraft if the remote controller is set as “Secondary”. Meanwhile, the “Secondary” remote controller cannot control the orientation of the aircraft. Reset the remote controller to “Primary” in DJI GO app if you wish to link the remote controller to the aircraft.

2. Search the “Primary” remote controller in the surrounding area in the “Request Control” section.

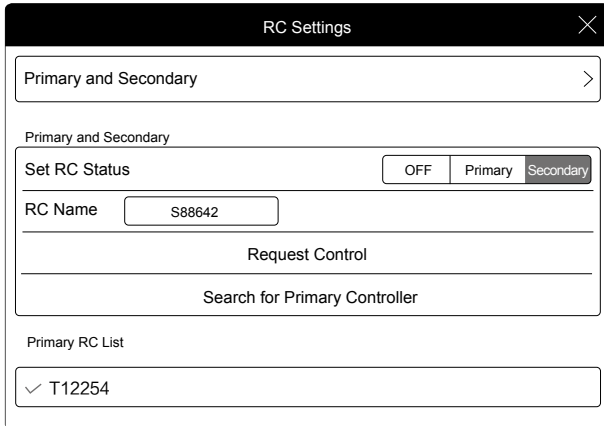

3. Select the “Primary” remote controller from the “Primary RC List” and input the connection password to connect to the desired “Primary” remote controller.

✓ T12254  
Primary RC List

Connection Password

1234

## Remote Controller Status LED

The Status LED reflects connection status between Remote Controller and aircraft. The RTH LED shows the Return to Home status of the aircraft. The table below contains details on these indicators.

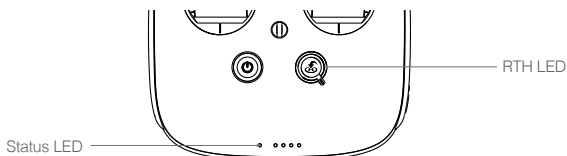

Status LED	Alarm	Remote Controller Status
— Solid Red	chime	The remote controller set as "Primary" but it is not connected with the aircraft.
— Solid Green	chime	The remote controller set as "Primary" and it is connected with the aircraft.
— Solid Purple	D-D-	The remote controller set as "Secondary" but it is not connected with the aircraft.
— Solid Blue	D-D-  chime	The remote controller set as "Secondary" and it is connected with the aircraft.
..... Slow Blinking Red	D-D-D.....	Remote controller error.
..... Red and Green/ Red and Yellow Alternate Blinks	None	HD Downlink is disrupted.
RTH LED	Sound	Remote Controller Status.
— Solid White	chime	Initiate RTH procedure.
..... Blinking White	D . . .	Send RTH command to aircraft.
..... Blinking White	DD . . . .	Aircraft returning to Home Point.

The Remote Status Indicator will blink red, sound an alert, when the battery level is critically low.

## Linking the Remote Controller

The remote controller is linked to your aircraft before delivery. Linking is only required when using a new remote controller for the first time. Follow these steps to link a new remote controller:

1. Power on the remote controller and connect to the mobile device. Launch DJI GO app.
2. Power on the Intelligent Flight Battery.
3. Enter "Camera" view and tap on and then tap "Linking Remote Controller" button as shown below.

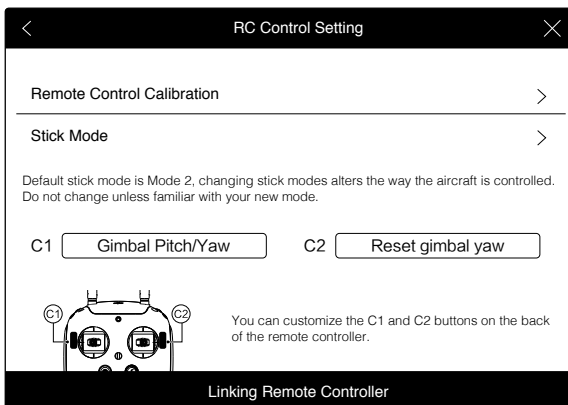

4. The remote controller is ready to link. The Remote Controller Status Indicator blinks blue and "beep" sound is emitted.

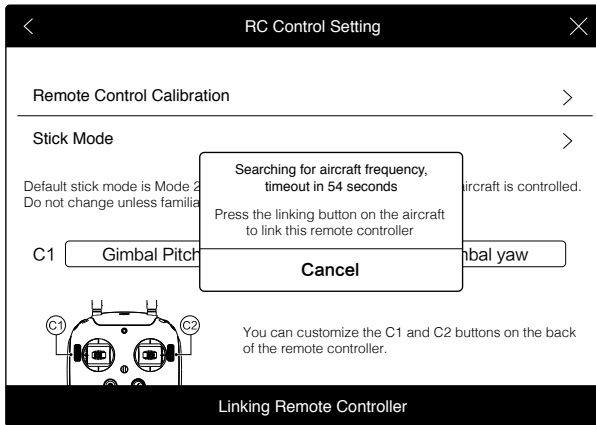

5. Locate the Linking button on the front of the aircraft, as shown in the figure shown below. Press the Linking button to start linking. The Remote Controller Status Indicator will display solid green if Link is succeed.

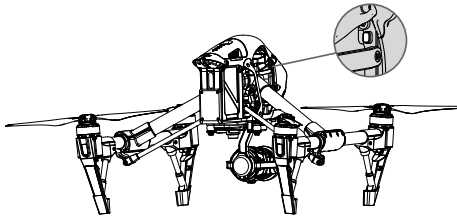

- Remote controller cannot link to the aircraft if the remote controller is set as "Secondary". Meanwhile, the "Secondary" remote controller cannot control the orientation of the aircraft. Reset the remote controller to "Primary" in DJI GO app if you wish to link the remote controller to the aircraft.
- Remote controller will disconnect from the linked aircraft if a new remote controller is linked to the same aircraft.

## Remote Controller Compliance Version

The remote controller is compliant with both CE and FCC requirements.

## Used with the DJI Focus

DJI Focus is fully compatible with the Zenmuse X5 series gimbal and camera. No calibration is required when using the Focus with the Zenmuse X5 camera.

### Connection

To allow communication between the two devices, connect the communication port on the Focus remote controller to the CAN Bus port on the Inspire 1 remote controller using the dedicated CAN Bus cable.

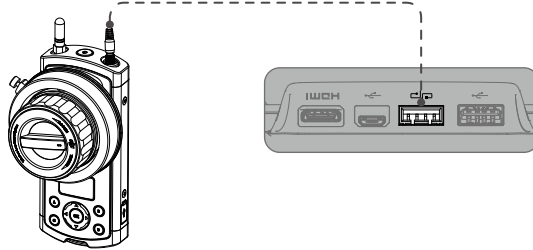

- Ensure that the Zenmuse X5 camera is set in AF mode.
  - Refer to "DJI FOCUS User Manual" for more information.
-



# Gimbal and Camera

---

This chapter provides the technical specifications of the camera and explains the working mode of the gimbal.

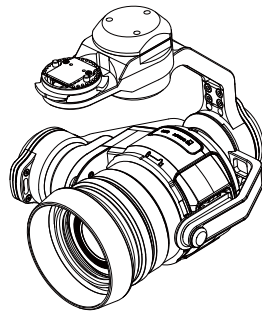

# Camera and Gimbal

## Camera Profile

The Zenmuse X5 offers advanced photographers a high-performance, robust gimbal and camera system with an M4/3 interchangeable lens. The Type 4/3 CMOS sensor supports video recording in 4K and 16MP still photos.

The Zenmuse X5 lens kit comes with the DJI MFT 15mm f/1.7 ASPH that provides a 72 degree field of view and a manually adjustable f/1.7-f/16 aperture range. The camera can shoot burst, AEB or time-lapse in JPEG and DNG RAW, and output video in MP4 and MOV formats. Live HD video from the camera can be viewed on your mobile device through the DJI GO app.

The 3-axis gimbal provides an incredibly stable platform for the camera to capture clear shots even during high speed maneuvers. The gimbal tilts the camera across a -90° to +30° pitch angle and pans a full 360 degrees.

## Camera Micro-SD Card Slot

To store your photos and videos, plug in the micro-SD card into the slot shown below before powering on the Inspire 1 Pro. The Inspire 1 Pro comes with a 16GB micro-SD card and supports up to a 64GB micro-SD card. A UHS-1 type micro-SD card is recommended, because the fast read and write capability of these cards enables you to store high-resolution video data.

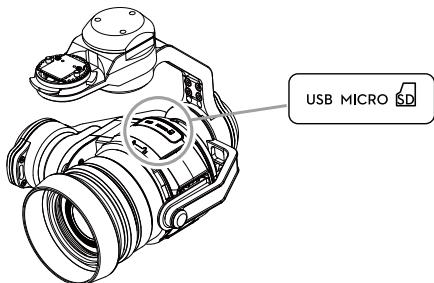

---

⊘ Do not remove micro-SD card from the Inspire 1 Pro when it is powered on.

---

## Camera Data Port

Power on the Inspire 1 Pro and then connect a USB cable to the Camera Data Port to download photos or videos from the camera to your computer.

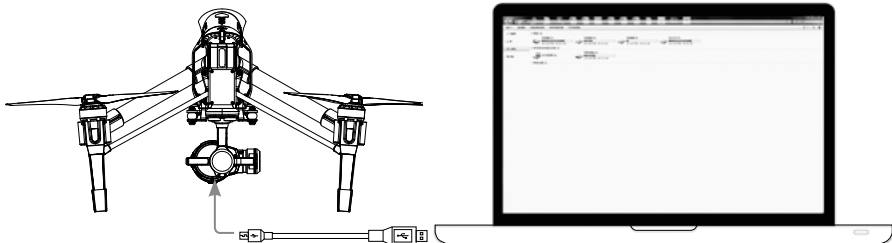

 Power on the aircraft before attempting to download the files.

## Status LED

The Status LED describes the working status of the camera.

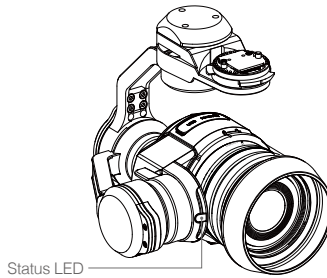

Status LED	Camera Status
Solid Green	Powered on; system is on standby.
Blinks Green quickly (0.1 on, 0.2s off)	System is warming up.
Blinks Green once (0.2s off)	Taking a single photo.
Blinks Green 3 times (0.2s on, 0.2s off)	Burst shooting 3 to 5 photos.
Blinks Red slowly (0.8s on, 0.8s off)	Recording video.
Blinks Green and Red alternatively (0.8s Green, 0.8s Red)	Firmware update in progress.
Blinks Red quickly (0.2s on, 0.3s off)	SD card error.
Solid Red	Firmware update failed.
Blinks Red twice (0.1s on, 0.1s off)	Camera overheated.

## Camera Operation

Use the Shutter and Record button on the remote controller to shoot the images or the videos through the DJI GO app. For more information about how to use these buttons, refer to "Controlling Camera" P27.

## Gimbal

### Gimbal Profile

The 3-axis Gimbal provides a steady platform for the attached camera, allowing you to capture stabilized images and video. The Gimbal can tilt the camera up to 120 degrees and rotate 360 degrees.

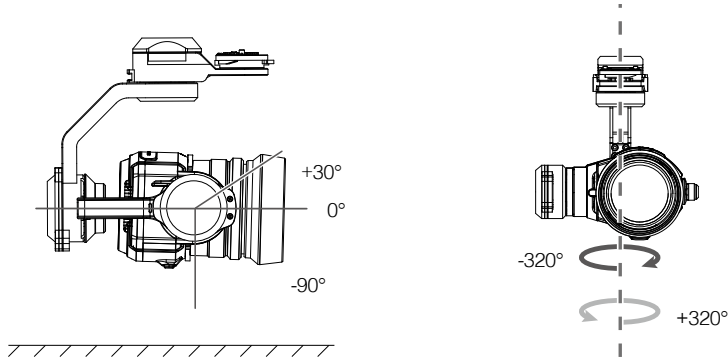

Use the gimbal dial on the remote controller to control pitch movement of the camera by default. Note that you cannot control the pan motion of the camera by default. Enable the "Primary-and-Secondary" mode and set the remote controller to "Secondary" state if you wish to control both the pan and pitch movement of the camera.

### Pan Control

Follow the instructions below to use the gimbal dial to control the pan movement of the gimbal:

1. Power on the aircraft and remote control, launch DJI GO app and enter "Camera" page.
2. Tap "RC Control Settings" icon and select either C1 or C2 customizable button as the gimbal pitch/yaw switching button.
3. Select "Gimbal Pitch/Yaw" from the dropdown list.

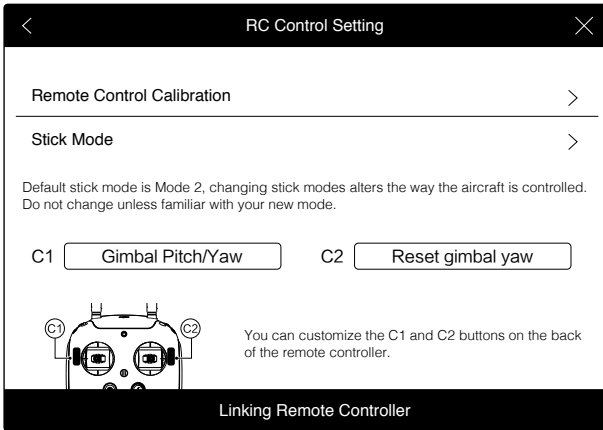

Press C1 or C2 button to switch from pitch mode to yaw mode. You may use the gimbal dial to pan the gimbal under yaw mode. Press C1 or C2 again to exit yaw mode.

While pressing the C1 button, turn the gimbal dial to focus the X5 camera manually.

While pressing the C2 button, turn the camera settings dial to fine tune the roll axis of the gimbal.

### Using DJI GO App to Control Gimbal

Follow the steps below to use DJI GO app to control the gimbal orientation:



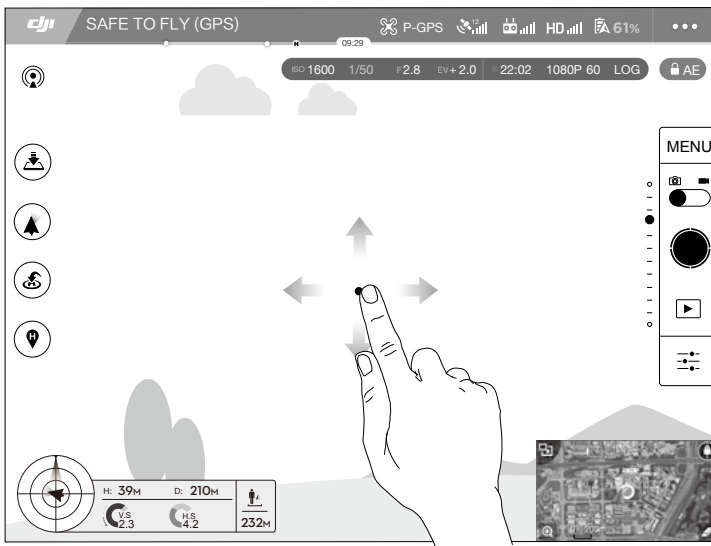

1. Launch DJI GO app, enter "Camera" page.
2. Tap and press on the screen until a blue circle is shown.
3. Slide to control the gimbal orientation within the "Camera" page as shown below.

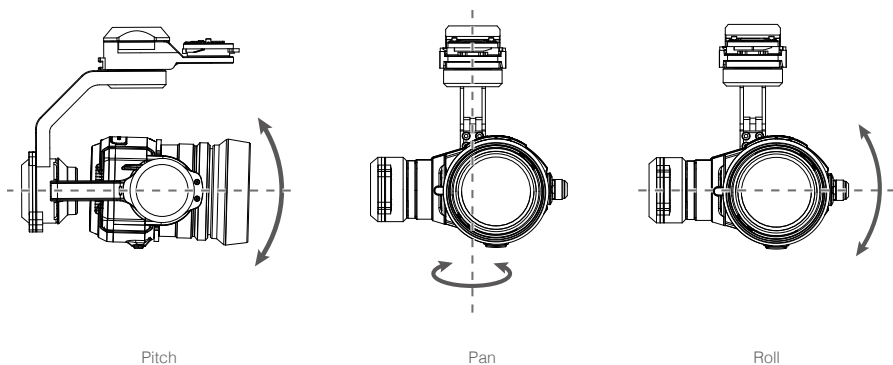

## Gimbal Operation Modes

Three Gimbal operation modes are available. Switch between the different operation modes on the Camera page of the DJI GO App. Note that your mobile device must be connected to the remote controller for changes to take effect. Refer to the table below for details:



	Follow Mode	The angle between Gimbal's orientation and aircraft's nose remains constant at all times. One user alone can control the pitch motion of the Gimbal, but a second user is required to control the pan motion using a second remote controller.
	FPV Mode	The Gimbal will lock to the movements of the aircraft to provide a First-Person-View flying experience.
	Free Mode	The Gimbal's motion is independent of the aircraft's orientation. One user alone can control the pitch motion of the Gimbal, but a second user is required to control the pan motion using a second remote controller.
	Re-alignment	Tap to force the Gimbal orientation to re-align with aircraft's orientation by panning from gimbal's current orientation. Pitch angle will remain unchanged during the re-alignment.
	<ul style="list-style-type: none"> <li>Gimbal motor error may occur in these situations: (1) Gimbal is placed on uneven ground. (2) Gimbal has received an excessive external force, e.g. a collision. Please take off from flat, open ground and protect the gimbal after powering up.</li> <li>Flying in heavy fog or cloud may make the gimbal wet, leading to a temporary failure. The gimbal will recover when it dries out.</li> <li>When the shutter speed is shorter than 1/125 seconds or the aircraft is flying quickly, the aircraft's vibration will increase and the gimbal will be affected by the greater wind, which may cause the jello effect. It is recommended to use an ND Filter, reduce the aperture to increase exposure time, or reduce flight speed to reduce the jello effect.</li> </ul>	

# DJI GO App

---

This chapter describes the four main GUI of the DJI GO app.

# DJI GO App

The DJI GO app is a new mobile app designed specifically for the Inspire 1 Pro. Use this app to control the gimbal, camera and other features of your flight system. The app also comes with Map, Store a User Center, for configuring your aircraft and sharing your content with friends. It is recommended that you use a tablet for the best experience.

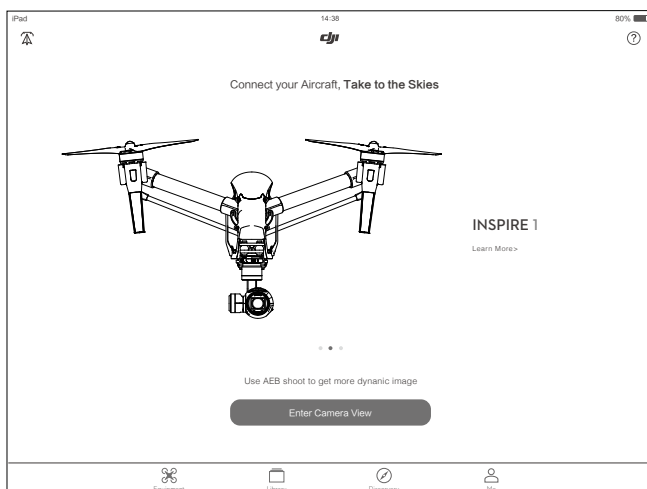

## Camera

The Camera page contains a live HD video feed from the Inspire 1 Pro's camera. You can also configure various camera parameters from the Camera page.

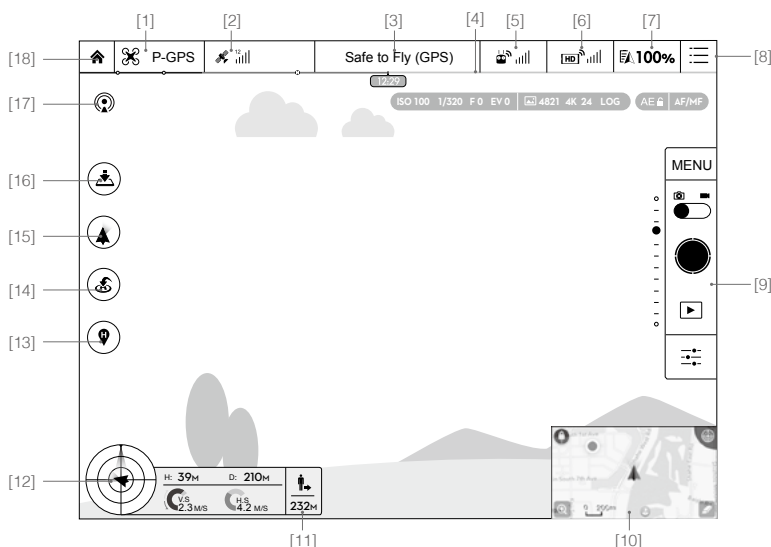



**[1] Flight Mode**

: The text next to this icon indicates the current flight mode.

Tap to configure the MC (Main Controller) Settings. These settings allow you to modify flight limits and set the gain values.

**[2] GPS Signal Strength**

: This icon shows the current strength of GPS signals. Green bars indicate adequate GPS strength.

**[3] System Status**

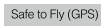
: This icon indicates the current aircraft system status and GPS signal strength.

**[4] Battery Level Indicator**

: The battery level indicator provides a dynamic display of the battery level. The colored zones on the battery level indicator represent the power levels needed to carry out different functions.

**[5] Remote Controller Signal**

: This icon shows the strength of remote controller's signal.

**[6] HD Video Link Signal Strength**

: This icon shows the strength of the HD video downlink connection between the aircraft and the remote controller.

**[7] Battery Level**

 **100%**: This icon shows the current battery level.

Tap to view the battery information menu, set the various battery warning thresholds, and view the battery warning history.

**[8] General Settings**

: Tap this icon to view the General Settings page. From this page, you can set flight parameters, reset the camera, enable the quick view feature, adjust the gimbal roll value, and toggle the flight route display.

**[9] Camera Operation Bar****MENU: Photo Styles**

Tap MENU ->  -> Style to choose from the following styles:

**1. Standard**

A general-purpose style for most scenes.

**2. Landscape**

The camera will focus on as much of the scene as possible by using a large depth of field.

**3. Soft**

Suitable for scenes with natural or soft colors.

## 4. Custom

Sharpness: -3 to +3

Contrast: -3 to +3

Saturation: -3 to +3

**MENU: White Balance**Tap MENU ->  -> White Balance to choose from the following modes:

## 1. Auto

The camera adjusts the white balance automatically.

## 2. Sunny / Cloudy / Incandescent / Neon

Choose one of these modes if natural-looking colors cannot be achieved through photo styles.



## 3. Custom (2000K~10000K)

Set a value between 2000K and 10000K to compensate for a specific light source.

**MENU: List of Settings**

<b>Photo</b>	
Shooting Modes	Single shoot, Burst Mode, AEB(3/5 bracketed frames), Time-lapse
Image Format	JPEG, DNG, JPEG+DNG
Image Size	4:3, 16:9
White Balance	Auto, Sunny, Cloudy, Incandescent, Neon, Custom (2000K~10000K)
Style	Standard, Landscape, Soft, Custom (Sharpness/Contrast/ Saturation)
Color	LOG, None, Vivid, Black White, Art, Film, Beach, Dream, Classic, Nostalgia
<b>Video</b>	
Video Size	UHD:4K (4096×2160) 24/25p, 4K (3840×2160) 24/25/30p, 2.7K (2704×1520) 24/25/30p; FHD:1920×1080 24/25/30/48/50/60p
Video Format	MOV, MP4
NTSC/ PAL	PAL, NTSC
White Balance	Auto, Sunny, Cloudy, Incandescent, Neon, Custom (2000K~10000K)
Style	Standard, Landscape, Soft, Custom (Sharpness/Contrast/ Saturation)
Color	LOG, None, Vivid, Black White, Art, Film, Beach, Dream, Classic, Nostalgia
<b>General</b>	
Quick Preview	Off, 1s, 2s, 3s, 4s, 5s, 6s, 7s, 8s, 9s, and 10s
Anti-Flicker	Auto, 60Hz, and 50Hz
Show Grid	Off, Grid Line, Grid + Diagonal, Center Point
File Index Mode	Reset, Continuous
Others	Show Histograms, Video Captions, Lens Profile, Reset Camera Settings, Format SD Card

### : Taking Photos

Slide the Photo/Video Switch to the  position. Tap the  button or the shutter button on the remote controller to take a single photo. Choose from one of the shooting modes by tapping "MENU" -> -> Photo.

#### 1. Burst Mode

Take 3, 5, or 7 shots in a row.

#### 2. AEB (Auto Exposure Bracketing)

Take 3 or 5 bracketed frames with  $\pm 0.7\text{EV}$  steps for exposure compensation.

#### 3. Time-lapse

Take photos in 5, 7, 10, 20 or 30 second intervals.

### : Recording Videos

Slide the Photo/Recording Switch to the  position. Tap the icon or the Record Button on the remote controller to start or stop recording video.

### : Exposure Modes

Tap  to choose from the following exposure modes:

#### 1. AUTO

The shutter speed and aperture are set automatically to obtain the correct exposure.

#### 2. S (Shutter Priority)

Set your desired shutter speed, while the camera chooses the aperture automatically. This mode is ideal for freezing action, creating motion blur or low-light shots.

#### 3. A (Aperture Priority)

Set your desired aperture, while the camera chooses the shutter speed automatically. This mode provides a wider depth of field and can be used to blur out backgrounds.

#### 4. M (Manual Exposure)

In general, increase the ISO for low light environments, and decrease the ISO if the surrounding is very bright.

### : Playback



Tap  in the DJI GO app or press the Playback Button on the remote controller to review photos and videos that you have captured. Press the same button again to return to capturing images.

### [10] Map

Display the flight path of the current flight. Tap to switch from the Camera GUI to the Map GUI.



[11] Aircraft Distance

 : The distance of the aircraft from the Home Point. When the aircraft is near the ground, this icon will change to  to display the height the Vision Position System's sensors from the ground.

[12] Flight Telemetry

Flight attitude is indicated by the flight attitude icon.

- (1) The red arrow shows which direction the aircraft is facing.
- (2) Light blue and dark blue areas indicate pitch.
- (3) The angle of the boundary between the light blue and dark blue areas indicates the roll angle.

[13] Home Point Settings

 : Tap this button to reset the current home point. You may choose to set the aircraft take-off location, the remote controller's current position, or the aircraft's current position as the Home Point.

[14] Return to Home (RTH)

 : Initiate RTH home procedure. Tap to have the aircraft return to the latest home point.

[15] Gimbal Operation Mode

Refer to "Gimbal Operation Mode" P42 for more information.

[16] Auto Takeoff/Landing

 : Tap to initiate auto takeoff or landing.

[17] Livestream

 : Livestream icon indicates the current video feed is broadcasting live on YouTube. Be sure the mobile data service is available on the mobile device.

[18] Back

 : Tap to return to the main GUI.

## Library

View, edit and share your artwork all in one place. The Library has a range of simple but powerful tools that let you edit your videos and photos before sharing them online, minutes after they are captured.

## Explore

Find out about our latest events, featured products and trending Skypixel uploads in the Explore page.

## Me

If you already have a DJI account, you will be able to participate in forum discussions, earn Credits in the DJI Store, and share your artwork with the community

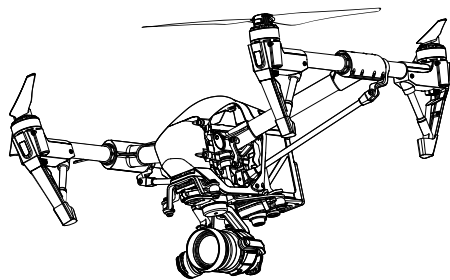

## Flight

---

This chapter describes the flight safety and flight restrictions.

# Flight

Once pre-flight preparation is complete, it is recommended to use the flight simulator to learn how to fly safely. Ensure that all flights are carried out in a suitable location.

## Flight Environment Requirements

1. Do not use the aircraft in severe weather conditions. These include wind speed exceeding 10m/s , snow, rain and smog.
2. Only fly in open areas. Tall buildings and steel structures may affect the accuracy of the on-board compass and GPS signal.
3. Avoid from obstacles, crowds, high voltage power lines, trees or bodies of water.
4. Minimize electromagnetic interference by not flying in area with high levels of electromagnetism, including mobile phone base stations or radio transmission towers.
5. Aircraft and battery performance is subject to environment factor such as air density and temperature. Be very careful when flying 14700 feet (4500 meters) or more above sea level as battery and aircraft performance may be reduced.
6. The Inspire 1 Pro cannot operate within the polar areas in "P" mode.

## Flight Limits and Flight Restriction Area

Flight limits on height and distance can be set. The details of these flight limits are described in the following section.

All unmanned aerial vehicle (UAV) operators should abide by all regulations from such organizations as the ICAO (International Civil Aviation Organization), FAA and their own national airspace regulations. For safety reasons, the flight limits function is enabled by default to help users use this product safely and legally. The flight limits function includes height limits, distance limits and No Fly Zones.

When operating in P Mode, height, distance limits and No Fly Zones work together to manage flight. In A mode only height limits work and flights cannot go higher than 120 meters.

### Max Height & Radius Limits

Max Height & Radius limit flying height and distance, and the user may change these settings in the DJI GO App. Once complete, your Inspire 1 Pro will fly in a restricted cylinder that is determined by these settings. The tables below show the details of these limits.

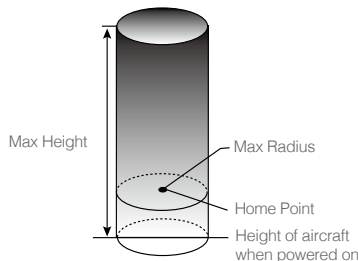

---

**GPS Signal Strong  ..... Blinking Green**

	Flight Limits	DJI GO App	Aircraft Status Indicator
Max Height	Flight altitude must be under the set height.	Warning: Height limit reached.	None.
Max Radius	Flight distance must be within the max radius.	Warning: Distance limit reached.	

---

**GPS Signal Weak  ..... Blinking Yellow**

	Flight Limits	DJI GO App	Aircraft Status Indicator
Max Height	Height is restricted to 98 feet (30 meters) when the GPS signal is weak and Vision Positioning is inactivated.	Warning: Height limit reached.	None.
Max Radius	No limits		

---



- If you fly out of the limit, you can still control the Inspire 1 Pro, but cannot fly it further.
  - If the Inspire 1 Pro flies out of the max radius in Ready to Fly (non-GPS) mode, it will fly back within range automatically.
- 

## No-Fly Zones

All No-Fly Zones are listed on the DJI official website at <http://www.dji.com/flysafe/no-fly>. No-Fly Zones are divided into Airports and Restricted Areas. Airports include major airports and flying fields where manned aircraft operate at low altitudes. Restricted Areas include borders between countries or sensitive sites. The details of the No-Fly Zones are explained below:

### Airport:

- (1) Airport No-Fly Zones are comprised of Takeoff Restricted Zones and Restricted-Altitude Zones. Each zone features circles of various size.
- (2) R1 depends on the size and shape of the airport, and is an area around the airport that is a Takeoff Restricted Zone, inside of which take-off and flight is prevented.
- (3) From R1 to R1+1 mile around the airport, the flight altitude is limited on a 15 degree incline, starting at 65 feet (20 meters) from the edge of airport and radiating outward. The flight altitude is limited to 1640 feet (500 meters) at R1+1 mile.
- (4) When the aircraft is within 320 feet (100 meters) of the No-Fly Zones, a warning message will appear in the DJI GO app.

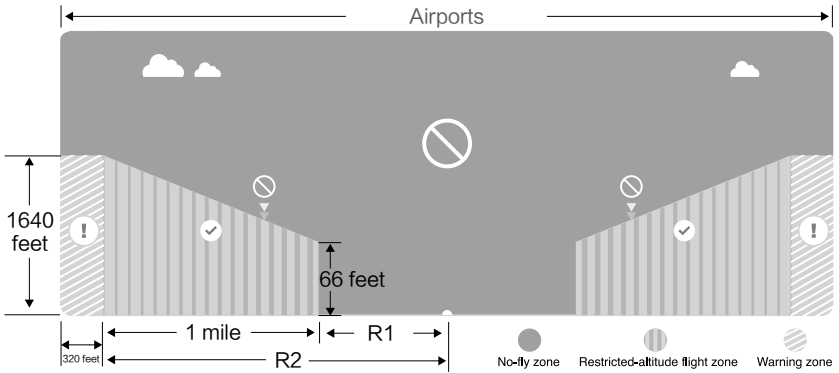





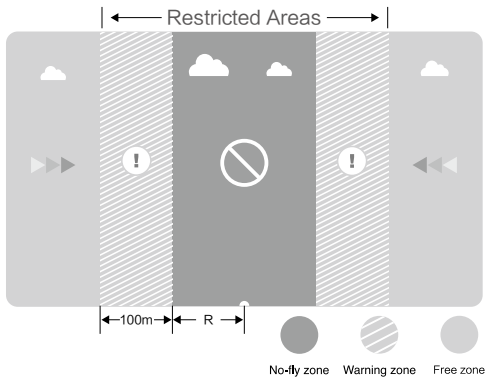

**Restricted Areas:**

- (1) Restricted Areas do not have a flight altitude restriction.
- (2) R around the designated Restricted Area is a Take-off Restricted area. Aircraft cannot takeoff within this zone. The value of R varies depending on the definition of the Restricted Area.
- (3) A "warning zone" has been set around each Restricted Area. When the aircraft is within 0.6 miles (1 km) of this zone, a warning message will appear in the DJI GO app.





GPS Signal Strong  .....Blinking Green			
Zone	Restriction	DJI GO App Prompt	Aircraft Status Indicator
No-fly Zone 	Motors will not start.	Warning: You are in a No-fly zone. Take off prohibited.	 ..... Red flashing
	If the aircraft enters the restricted area in A mode but P mode activates the aircraft will automatically descend to land then stop its motors after landing.	Warning: You are in a No-fly zone, automatic landing has begun. (If you are within 1.5 mile radius)	
Restricted-altitude flight zone 	If the aircraft enters the restricted area in A mode but P mode activates, it will descend to a safe altitude and hover 15 feet below the safe altitude.	Warning: You are in a restricted zone. Descending to safe altitude. (If you are between the range of 1.5 mile and 5 mile radius) Warning: You are in a restricted zone. Max flight height restricted to between 10.5m and 120m. Fly Cautiously.	
Warning zone 	No flight restriction applies, but there will be warning message.	Warning: You are approaching a restricted zone, Fly Cautiously.	
Free zone 	No restrictions.	None.	



Semi-automatic descent: All stick commands are available except the throttle stick command during the descent and landing process. Motors will stop automatically after landing.



- When flying in the safety zone, aircraft status indicator will blink red quickly and continue for 3 seconds, then switch to indicate current flying status and continue for 5 seconds at which point it will switch back to red blinking.
- For safety reasons, please do not fly close to airports, highways, railway stations, railway lines, city centers and other special areas. Try to ensure the aircraft is visible.

## Preflight Checklist

1. Remote controller, aircraft battery, and mobile device are fully charged.
2. Propellers are mounted correctly and firmly.
3. Micro-SD card has been inserted if necessary.
4. Gimbal is functioning as normal.
5. Motors can start and are functioning as normal.
6. DJI GO app connected to the aircraft.

## Calibrating the Compass

Only calibrate the compass when the DJI GO app or the status indicator prompt you to do so. Observe the following rules when calibrating your compass:

1. DO NOT calibrate your compass where there is a chance of strong magnetic interference, such as magnetite, parking structures, and steel reinforcements underground.
2. DO NOT carry ferromagnetic materials with you during calibration such as cellular phones.
3. The DJI GO app will prompt you to resolve the compass issue if the compass is affected by strong interference after calibration is complete. Follow the prompted instructions to resolve the compass issue.

### Calibration Procedures

Choose an open space to carry out the following procedures.

1. Ensure that the compass is calibrated. If you did not calibrate the compass as part of your pre-flight preparations, or if you have moved to a new location since the last calibration, tap Aircraft Status Indicator bar in the app and select "Calibrate", then follow the on-screen instructions.
2. Hold and rotate the aircraft horizontally 360 degrees, and the Aircraft Status Indicator will display a solid green light.

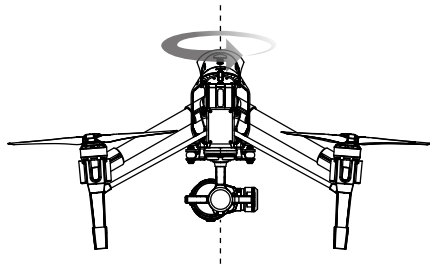

3. Hold the aircraft vertically with nose pointing downward, and rotate it 360 degrees around the center axis. Recalibrate the compass if the Aircraft Status Indicator show solid red.

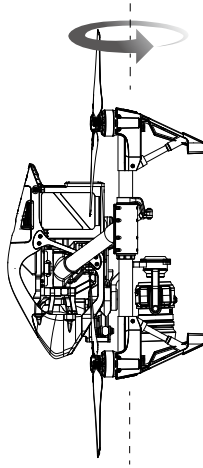

- 
-  If the Aircraft Status Indicator blinks red and yellow after the calibration, move your aircraft to a different location to carry out compass calibration.
- 

-  Calibrate the compass before each flight. Launch DJI GO App, follow the on-screen instruction to calibrate the compass.
- 

### When to Recalibrate

1. When compass data is abnormal, and the Aircraft Status Indicator is blinking red and yellow.
2. When flying in a new location, or a location that is different from your last flight.
3. When the mechanical structure of the Inspire 1 Pro has changed, i.e. changed mounting position of the compass.
4. When severe drifting occurs in flight, i.e. the Inspire 1 Pro does not fly in straight lines.

## Auto Take-off and Auto Landing

### Auto Take-off

Use auto take-off to take off your aircraft automatically if the Aircraft Status Indicator displays blinking green. Follow the steps below to use auto take-off:

1. Launch DJI GO app, enter camera page.
2. Ensure the aircraft is in "P" mode.
3. Go through the pre-flight checklist.
4. Tap "", and confirm flight condition. Slide to confirm and take-off.
5. Aircraft takes off and hovers at 1.2 meters above ground.

### Auto-Landing

Use auto-landing to land your aircraft automatically if the Aircraft Status Indicator displays blinking green. Follow the steps below to use auto-landing:

1. Ensure the aircraft is in "P" mode.
2. Check the landing area condition before tapping "↓", to perform landing.
3. Aircraft lowers the landing gear and proceed to land automatically.

☀️: Landing gear will automatically raise when the aircraft reaches an altitude of 1.2m for the first time, and automatically lower every time it descends to 0.8m. Users can turn this feature ON/OFF in the GO app.

## Starting/Stopping the Motors

### Starting Motors

The Combination Stick Command (CSC) listed below are used to start the motors instead of simply pushing the stick up. Ensure that you perform the CSC in one motion.



### Stopping Motors

There are two methods to stop the motors.

Method 1: When the Inspire 1 Pro has landed, push the throttle down ①, then conduct CSC ②. Motors will stop immediately. Release both sticks once motors stop.

Method 2: When the aircraft has landed, push the throttle down and hold. The motors will stop after 3 seconds.



⚠️ Do not perform CSC when aircraft is in midair, otherwise the motors will be stopped.

## Flight Test

### Take off/Landing Procedures

1. Place the aircraft on open, flat ground with battery indicators facing towards you.
2. Power on the remote controller and your mobile device, then the Intelligent Flight Battery.
3. Launch the DJI GO App and enter the Camera page.
4. Wait until the Aircraft Indicator blinks green. This means the Home Point is recorded and it is safe to fly now. If it flashes yellow, it means Home Point is not recorded, and you should not take off.
5. Push the throttle up slowly to take off or using Auto Take-off to take off.

6. Shoot photos and videos using the DJI GO app.
7. To land, hover over a level surface and gently pull down on the throttle slowly to descend.
8. After landing, execute the CSC command or hold the throttle at its lowest position for 3 seconds or more until the motors stop.
9. Turn off the Intelligent Flight Battery first, followed by the Remote Controller.



- When the Aircraft Status Indicator blinks yellow rapidly during flight, the aircraft has entered Failsafe mode.
  - A low battery level warning is indicated by the Aircraft Status Indicator blinking red slowly or rapidly during flight.
  - Watch video tutorials about flight for more flight information.
- 

### Video Suggestions and Tips

1. Work through the checklist before each flight.
2. Select desired gimbal working mode in the DJI GO app.
3. Aim to shoot when flying in P mode only.
4. Always fly in good weather, such as sunny or windless days.
5. Change camera settings to suit you. These include photo format and exposure compensation.
6. Perform flight tests to establish flight routes and scenes.
7. Push the sticks gently to make aircraft movements stable and smooth.

# FAQ

---

# Troubleshooting (FAQ)

- 1. How can I put a GoPro camera on the Inspire 1 Pro?**

The Inspire 1 Pro does not currently support GoPro attachments. The gimbal is designed to hold DJI cameras only.
- 2. When will ground station functionality be available?**

The Inspire 1 Pro does not currently support ground station. Ground station will be available with future firmware updates.
- 3. Is the camera's exposure automatic?**

The exposure can be set to Auto, for automatic changes, or Manual, if you wish to use a specific setting.
- 4. Can I see the size of images through the app?**

Yes, you can preview image or video sizes through the DJI GO app.
- 5. How much weight can the Inspire 1 Pro carry without its included camera?**

We do not recommend flying with any payload other than the included DJI gimbal and camera.
- 6. Do you have an LCD monitor available for the Inspire 1 Pro?**

No, DJI does not sell LCD or HD monitors for the Inspire 1 Pro. However, you can output the live streaming video to a compatible monitor or mobile device of your own.
- 7. How long does it take to charge the battery? Does it come with a charger?**

Yes, all Inspire 1 Pro units come with standard TB47 charger.  
With the standard TB47 100W charger, it takes 85min to fully charge a 4500mAh battery.
- 8. Are the two remote controllers the same? Should I setup the remote controllers in the app or somewhere else to control the camera and aircraft separately?**

The two remote controllers are physically identical. You can set the remote controllers to either "Primary" or "Secondary" through the DJI GO app if you wish to use dual controller mode.
- 9. Where can I find info on the simulation application that plugs into the trainer port? Can you suggest a simulation program?**

There is no trainer port on the remote controller for the Inspire 1 Pro.
- 10. Can the mobile device holder be used on the Phantom 2 series remote controller?**

No, it cannot. The mobile device holder can only be used with the Inspire 1 Pro remote.
- 11. Does the Inspire 1 Pro have a SD card included?**

The Inspire 1 Pro comes with a 16GB micro-SD card. It supports SD cards up to 64GB.
- 12. Can I upgrade and buy a second remote controller if I only buy a single remote controller now?**

Yes.
- 13. How big is the Inspire 1 Pro?**

Its length x height x width dimensions without the propellers attached are 44 x 30 x 45cm (17.3 x 11.8 x 17.7in).

**14. What flight controller does the Inspire 1 Pro use?**

The Inspire 1 Pro uses its own new flight controller.

**15. Which motors and propellers does the Inspire 1 Pro come with?**

The Inspire 1 Pro uses 3510H motors and 1345T propellers.

**16. Aircraft frame arm joints appear loosen, is that normal?**

The space of the joints shown in the below figure is normal and it will not affect the performance of aircraft, do not adjust the position of the screws on your own.

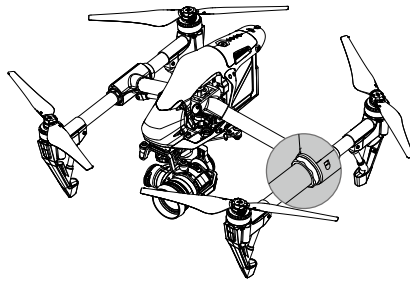

**17. Failed to complete self-check?**

Place the aircraft on the flat surface before powering on. Do not move the aircraft during the self-check.



# Appendix

---

# Appendix

## Specifications

Aircraft	
Model	T600
Weight	2870 g (Battery and propellers included, Zenmuse X5 excluded) 3400 g (Battery, propellers and Zenmuse X5 included)
Max Takeoff Weight	3500 g
Hovering Accuracy (P Mode)	Vertical: 0.5 m Horizontal: 2.5 m
Max Angular Velocity	Pitch: 300°/s Yaw: 150°/s
Max Tilt Angle	35°
Max Ascent Speed	5 m/s
Max Descent Speed	4 m/s
Max Speed	18 m/s (ATTI mode, no wind)
Max Service Ceiling Above Sea Level	4,500 m (Software altitude limit: 120 m above takeoff point)
Max Wind Speed Resistance	10 m/s
Max Flight Time	Approx. 15 minutes
Motor Model	DJI 3510H
Propeller Model	DJI 1345T
Indoor Hovering	Enabled by default
Operating Temperature	14° to 104° F (-10° to 40° C)
Diagonal Distance	559 mm
Gimbal and Camera	
General	
Name	Zenmuse X5
Dimensions	120 (W) x 135 (H) x 140 (D) mm
Weight	530 g (Including original lens, balancing ring, lens hood, Micro SD card)
Operating Temperature	32° to 104° F (0° to 40° C)
Camera	
Lens	Replaceable lens M43 mount supporting auto-focus
Supported Lenses	DJI MFT 15mm f/1.7 ASPH Panasonic Lumix G Leica DG Summilux 15mm f/1.7 ASPH Olympus M.Zuiko Digital ED 12mm f/2.0 Olympus M.Zuiko Digital ED 17mm f/1.8 Olympus M.Zuiko Digital ED 25mm f/1.8 Olympus M.Zuiko Digital ED 45mm f/1.8 (For still photography) Olympus M.Zuiko Digital ED 14-42mm f/3.5-5.6 EZ (For still photography)

Sensor	Type 4/3 CMOS sensor
Effective Pixels	16 M
Max Resolution	4608x3456
ISO Range	100-25600
Electronic Shutter Speed	8 s-1/8000 s
Field of View	DJI MFT 15mm f/1.7 ASPH 72°
Still Photography Modes	Single shot Burst shooting:3/5/7 frames Auto Exposure Bracketing (AEB):3/5 bracketed frames at 0.7EV bias Timelapse (3/5/7/10/20/30/60 sec)
Video Resolution	UHD:4K (4096×2160) 24/25p, 4K (3840×2160) 24/25/30p, 2.7K (2704×1520) 24/25/30p; FHD:1920×1080 24/25/30/48/50/60p
Max Video Bitrate	60 Mbps
Supported File Systems	FAT32 (≤ 32 GB), exFAT (> 32 GB)
Photo Formats	JPEG, DNG (RAW)
Video Formats	MP4/MOV (MPEG-4 AVC/H.264)
Supported Storage Devices	Class 10 or UHS-1 or above Micro SD cards Max capacity of 64 GB

#### Default Lens





Name	DJI MFT 15mm f/1.7 ASPH
Focal Length	f=15 mm (35 mm format equivalent 30 mm)
Aperture Type	7 diaphragm blades/circular aperture diaphragm
Maximum Aperture	F1.7
Minimum Aperture	F16
Lens Construction	9 elements in 7 groups (3 aspherical lenses)
In Focus Distance	0.2 m to ∞ (from the focus distance reference line)
Mount	Micro Four Thirds Mount
Angle of View	72°
Max Diameter	Approx. 2.26 inches (57.5 mm)
Overall Length	Approx. 1.42 inches (36 mm)
Weight	Approx. 115 g
Gimbal	
Angular Vibration Range	±0.02°
Mount	Detachable
Controllable Range	Pitch:-90° to +30° Pan:±320°
Max Controllable Speed	Pitch:120°/s Pan:180°/s
Remote Controller	
Name	C1
Operating Frequency	922.7MHz~927.7 MHz (Japan Only) 5.725~5.825 GHz;2.400~2.483 GHz

Max Transmitting Distance	FCC Compliant: 3.1 miles (5 km); CE Compliant: 2.1 miles (3.5 km) (unobstructed, free of interference)
EIRP	10 dBm@900 MHz, 13 dBm@5.8 GHz, 20 dBm@2.4 GHz
Video Output Ports	USB, Mini HDMI
Power Supply	Built-in battery
Charging	DJI charger
Dual User Capability	Primary-and-Secondary connection
Mobile Device Holder	Tablet or Smart Phone
Max Mobile Device Width	170 mm
Output Power	9 W
Operating Temperature	14° to 104° F (-10° to 40° C)
Storage Temperature	Less than 3 months: -4° to 113° F (-20° to 45° C) More than 3 months: 72° to 82° F (22° to 28° C)
Charging Temperature	32° to 104° F (0° to 40° C)
Battery	6000 mAh 2S LiPo
Charger	
Model	A14-100P1A
Voltage	26.3 V
Rated Power	100 W
Battery (Standard)	
Name	Intelligent Flight Battery
Model	TB47
Capacity	4500 mAh
Voltage	22.2 V
Battery Type	6S LiPo High voltage battery
Energy	99.9 Wh
Net Weight	570 g
Operating Temperature	14° to 104° F (-10° to 40° C)
Storage Temperature	Less than 3 months: -4° to 113° F (-20° to 45° C) More than 3 months: 72° to 82° F (22° to 28° C)
Charging Temperature	32° to 104° F (0° to 40° C)
Max Charging Power	180 W
Battery (Optional)	
Name	Intelligent Flight Battery
Model	TB48
Capacity	5700 mAh
Voltage	22.8 V
Battery Type	6S LiPo High voltage battery
Energy	129.96 Wh
Net Weight	670 g
Operating Temperature	14° to 104° F (-10° to 40° C)







Storage Temperature	Less than 3 months: -4° to 113° F (-20° to 45° C) More than 3 months: 72° to 82° F (22° to 28° C)
Charging Temperature	32° to 104° F (0° to 40° C)
Max Charging Power	180 W
Max Flight Time	Approx. 18 minutes
<b>Vision Positioning</b>	
Velocity Range	< 8 m/s @altitude 6.56 feet (2 m)
Altitude Range	0.16 - 16.4 feet (5-500 cm)
Operating Environment	Surfaces with clear patterns and adequate lighting (> 15 lux)
Operating Range	< 9.84 feet (300 cm)
<b>DJI GO App</b>	
Mobile Device System Requirements	iOS 8.0 (or later) and Android 4.1.2 (or later)
Supported Mobile Devices	Compatible with iPhone 5s, iPhone 6, iPhone 6 Plus, iPad Air, iPad Air Wi-Fi + Cellular, iPad mini 2, iPad mini 2 Wi-Fi + Cellular, iPad Air 2, iPad Air 2 Wi-Fi + Cellular, iPad mini 3, and iPad mini 3 Wi-Fi + Cellular. This app is optimized for iPhone 5s, iPhone 6, and iPhone 6 Plus. Compatible with Samsung tabs 705c, Samsung S6, Samsung S5, Samsung NOTE4, Samsung NOTE3, Google Nexus 9, Google Nexus 7 II, Ascend Mate7, Huawei P8 Max, Nubia Z7 mini, SONY Z3 EXPERIA, MI 3, MI PAD, Smartisan T1. *Support for additional Android devices available as testing and development continues.

## Aircraft Status Indicator Description

### Normal

 .....	Red, Green and Yellow Flash Alternately	Power on and self-check
 .....	Green and Yellow Flash Alternately	Aircraft warming up
 .....	Green Flashes Slowly	Safe to Fly (P mode with GPS and Vision Positioning)
 X2 .....	Green Flashes Twice	Safe to Fly (P mode with Vision Positioning but without GPS)
 .....	Yellow Flashes Slowly	Safe to Fly (A mode but No GPS and Vision Positioning)

### Warning

 .....	Fast Yellow Flashing	Remote Controller Signal Lost
 .....	Slow Red Flashing	Low Battery Warning
 .....	Fast Red Flashing	Critical Low Battery Warning
 .....	Red Flashing Alternately	IMU Error
 —	Solid Red	Critical Error
 .....	Red and Yellow Flash Alternately	Compass Calibration Required

## Intelligent Flight

Intelligent Flight mode includes Course Lock, Home Lock, Point of Interest (POI), Follow Me and Waypoints features to assist users to create professional shoots during the flight. Course Lock and Home Point lock helps to lock the orientation of aircraft so that the user can focus more on other operations. Point of Interest, Follow Me and Waypoints mode enable aircraft to fly automatically according to the pre-set flight maneuvers.

Course Lock	Lock the current nose direction as the aircraft's forward direction. The aircraft will move in the locked directions regardless of its orientation (yaw angle).
Home Lock	Pull the pitch stick backward to move the aircraft toward its recorded Home Point.
Point of Interest	The aircraft will orbit around the subject automatically to allow the operator can be more focus on framing their shoot on the subject in Point of Interest.
Waypoints	Record a flight path, then the aircraft will fly along the same path repeatedly while you control the camera and orientation. The flight path can be saved and re-apply in the future.

Enable Multiple Flight Mode by launching the DJI GO app > Camera View >  > Advanced Settings > Multiple Flight Mode before using the Intelligent Flight Mode for the first time.

## How to Update Firmware

Follow the process described below to upgrade the aircraft, remote controller and battery.

### Updating the Aircraft Firmware

#### Step 1- Check Battery and SD Card Capacity

Ensure the Intelligent Flight Battery has at least 50% power and there is at least 100 MB of free space on the SD card.

#### Step 2- Prepare the Firmware Update Package

1. Download the firmware update package from the official DJI website (<http://www.dji.com/product/inspire-1-pro-and-raw>).
2. Insert the SD card into your PC. Extract the all downloaded files into the root directory of the SD card. Remove the SD card from your PC. Ensure the aircraft is powered off then insert the SD card into the SD card slot on the camera.

#### Step 3- Update the Aircraft

1. Ensure the remote controller is powered off and then power on the aircraft. Upgrade will begin automatically after aircraft is powered on.
2. It will take approximately 25 minutes to complete the firmware update. The camera status indicator will blink green and red to indicate the upgrade is in progress and stop blinking when the update is complete with success.

3. Check the upgrade status by opening the ".txt" file that is automatically generated after the update. The update is successful if the text "result: successful" is in the document. Try upgrading the firmware again if the text "result: failed" is found or the camera status indicator shows solid red.

---

 Please note that firmware update may reset various Main Controller Settings, such as the RTH Altitude and Maximum Flight Distance, to factory defaults. Before the update, take note of your preferred DJI GO 4 settings, and readjust them after the update to suit your preference.

---

### Updating the Remote Controller Firmware

Ensure the DJI GO app has been updated to v1.2.0 before updating the remote controller. The System Status bar in Camera View of the DJI GO App will flash several times if a firmware update is available. Follow these steps to update the firmware via the DJI GO App.

#### Step 1- Check Battery and SD Card Capacity

1. The remote controller has at least 50% battery level.
2. Your mobile device is able to access the internet.
3. There is at least 30 MB of free space on your mobile device.

#### Step 2- Download and Update the Firmware

1. Go to the DJI GO App > Camera View > System Status bar > Overall Status. Tap Download the firmware update package to download and update the firmware. Track the update progress from progress bar in the DJI GO App. The status LED on the remote controller will blink blue during update and blink green when update is complete with success.

Firmware update through the DJI GO app will not work with older versions of the remote controller firmware. If the firmware update fails, follow the instructions below to update the firmware using the traditional method:

- a. Update the latest firmware package files from DJI official web site.
- b. Extract all downloaded files into the root directory of an SD card or USB flash drive.
- c. Turn off the remote controller, Insert the SD card into a SD card reader or the USB disk onto the remote controller USB port when remote controller is turned off.
- d. Power on the remote controller and wait 60 seconds until the upgrade begins. Do not power off the remote controller during the update.
- e. It will take approximately 10 minutes to complete the firmware update. The camera will sound a beeping sound and the Status LED on the remote controller shows solid blue to indicate the update is in progress. The Status LED on remote controller shows solid green and beeping sound will stop if the upgrade is completed with success.
- f. If you do not have a SD card reader, you may insert the SD card into the gimbal and connect the gimbal with remote controller to upgrade the remote controller.

- 
-  • You will only be able to update the remote controller firmware through the DJI GO app from this point onwards.
- Make sure to update your aircraft and gimbal before updating the Remote Controller. Otherwise, the Remote Controller will be disconnected to the aircraft due to firmware version not matched.
-

## Updating Intelligent Flight Battery Firmware

The Intelligent Flight Battery is upgraded during the aircraft firmware upgrade process. It is recommended to keep the upgrade package files in your SD card. The upgrade will start automatically after power cycling the aircraft.



- Ensure there is only one firmware package file stored on your SD card.
  - Only storage devices that are formatted for FAT32 and exFAT file systems are supported for aircraft and remote controller firmware updates.
  - Ensure the internet connection of your mobile device is stable when downloading the firmware update package.
  - Turn on Airplane Mode on your mobile device before updating the firmware, as any incoming calls may disrupt the update process.
  - Do not perform firmware update while the aircraft is still flying in the air. Only carry out firmware update when the aircraft is landed.
  - Be sure to update the remote controller's firmware to the latest version after you upgrade the aircraft's firmware.
  - The remote controller may become unlinked from the aircraft after updating. Re-link the remote controller and aircraft.
  - Confirm the update results based on the blinking pattern of camera status indicator or gimbal sound. It is normal for the aircraft to sound or the LED to blink during the update process.
- 



DJI incorporates HDMI™ technology.  
The terms HDMI and HDMI High-Definition Multimedia Interface, and the HDMI Logo are trademarks or registered trademarks of HDMI Licensing LLC in the United States and other countries.



This content is subject to change.

Download the latest version from  
[www.dji.com/product/inspire-1-pro-and-raw](http://www.dji.com/product/inspire-1-pro-and-raw)

If you have any questions about this document, please contact DJI by sending a message to [DocSupport@dji.com](mailto:DocSupport@dji.com).

© 2017 DJI. All Rights Reserved.

