

# REEXAMINATION OF THE 2004 FAILURE OF BIG BAY DAM, MISSISSIPPI<sup>1</sup>

Keith A. Ferguson, P.E., National Dam and Hydraulic Structures Practice Leader<sup>2</sup>  
Scott Anderson, P.E., National Technology Leader for Numerical Modeling<sup>3</sup>  
Elena Sossenkina, P.E., National Technology Leader for Risk<sup>4</sup>

## ABSTRACT

This paper provides a summary of a reexamination of the 2004 failure of Big Bay Dam based on a potential failure modes framework as outlined in the FEMA, Technical Manual: Conduits through Embankment Dams, 2005; and as further described by Ferguson et al, 2012. Of particular interest is the influence of piping and erosion through open defects in the outlet works conduit and how the full failure mode likely developed through a series of backward erosion initiation/continuation cycles that began under the upstream slope of the dam and moved toward the downstream end of the conduit over a period of about thirteen years. Results of idealized 2-dimensional seepage models of the development process are presented that help inform the assessment of this unique combination of failure mode steps. A generalized risk analysis event tree of the failure mode is presented and described.

## INTRODUCTION

On March 12, 2004, the Big Bay Lake Dam in Mississippi failed destroying 48 homes, washing out a bridge, and damaging 53 homes, 2 churches, three businesses and a fire station. Thankfully, no lives were lost. The dam was built in 1990-1991, had a structural height of about 60 to 70 feet, and a normal pool storage capacity of about 11,250 acre-feet. Both embankment and foundation soils at the site are comprised of primarily highly erodible silty sand and sandy silt materials. The estimated peak outflow from the breach was approximately 150,000 cubic feet per second. While there were some important warning signs of a developing problem, the final cycle of the continuation phase of the failure mode development process appears to be in the range of about 24 to 48 hours and the full breach developed, including the period of rapid progression (gross enlargement) and breach formation, in a period of about 2 to 4 hours

The State of Mississippi requested the ASDSO Dam Failure Investigation Committee to complete a reexamination of this failure following the draft guidelines that the committee has developed (ASDSO, 2011). An assessment and resulting description of the potential failure mode (PFM) that led to the breach formation is a central component of that reexamination presented in this paper.

Big Bay Dam is located in central Mississippi as shown on Figure 1. An aerial photograph of the breach immediately following the failure is shown on Figure 2 and a

---

<sup>1</sup> Paper was first published as part of the United States Society of Dams, 2014 Annual Conference, April 2014, San Francisco.

<sup>2</sup> HDR Engineering, Inc., 1670 Broadway, Suite 3400, Denver, CO 80202, 303-764-1546, [keith.ferguson@hdrinc.com](mailto:keith.ferguson@hdrinc.com).

<sup>3</sup> HDR Engineering, Inc., 1670 Broadway, Suite 3400, Denver, CO 80202, 303-764-1546, [scott.t.anderson@hdrinc.com](mailto:scott.t.anderson@hdrinc.com).

<sup>4</sup> HDR Engineering, Inc., 1670 Broadway, Suite 3400, Denver, CO 80202, 303-764-1546, [elena.sossenkina@hdrinc.com](mailto:elena.sossenkina@hdrinc.com)

view of the breach from the upstream slope of the dam and south of the breach is shown on Figure 3.

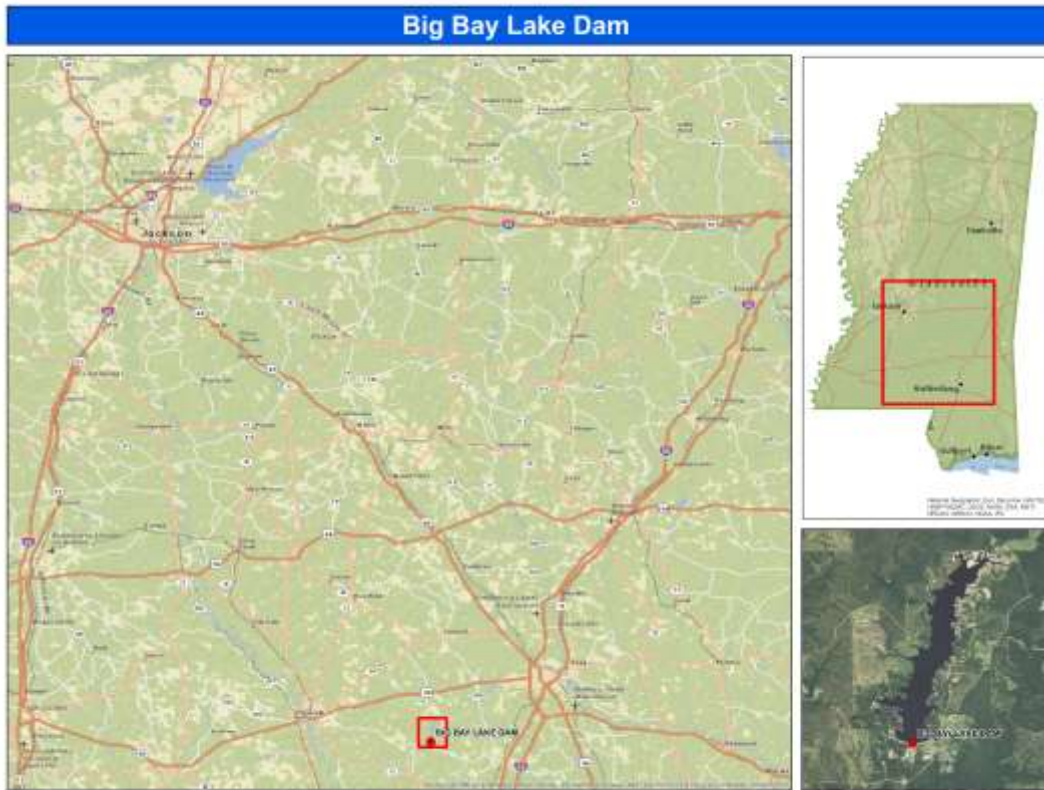

Figure 1. Project Location Map.

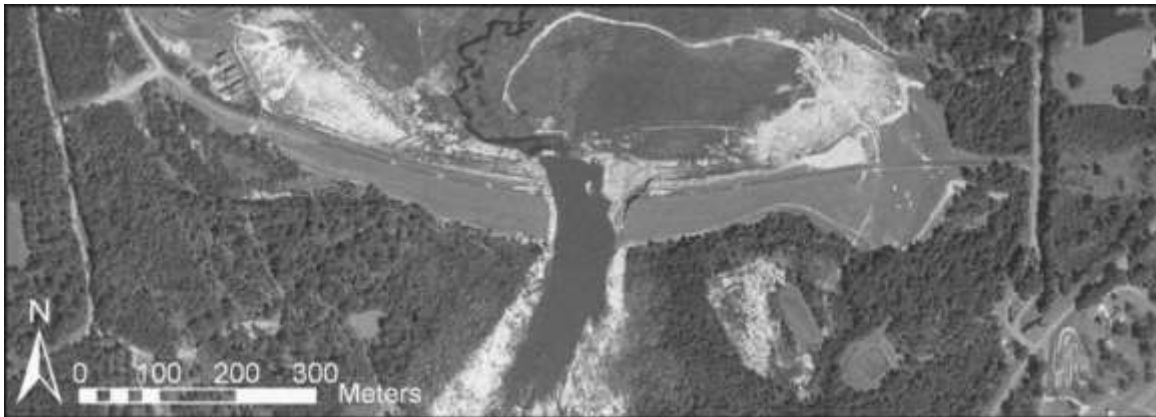

Figure 2. Aerial View of Breach Immediately Following Failure of the Dam



Figure 3. Photo of Dam Breach from Upstream Slope.

The breach that formed in the dam was in the general vicinity of the outlet conduit and resulted in total failure of the outlet intake structure, conduit through the embankment at the foundation contact, and the outlet discharge structure. As described in a subsequent section of this paper, the root cause of the failure was never conclusively established during the subsequent investigation and litigation phases of the project. While several theories were postulated by different parties, the author's examination of the information from the investigations and trial activities along with their general experience with seepage failure modes suggests that the failure mode development process was complex. Contributing factors may have included defects in the outlet conduit, lack of effective seepage control in the central core of the dam, poorly designed and constructed seepage filter and collection systems in the downstream portion of the dam and foundation, and lack of proper instrumentation and monitoring of the dam. The very poor design, remedial construction, and inspection/monitoring records at the dam will not permit conclusive establishment of the root cause of failure. However, a potential failure modes (PFM) framework to reexamine the available information has been highly informative.

### **DESCRIPTION OF THE EVENTS LEADING TO BREACH DEVELOPMENT**

There were two eye witnesses to the failure of the dam including the Owner's Maintenance Man, and the Engineer responsible for inspections and any safety related corrective actions. Outlined below are the descriptions of the failure development process from Thursday afternoon, March 11, 2004 through Friday afternoon, March 12, 2004 at about 12:25 pm.

1. The Owner's Maintenance Man had been notified by one of the residents in the area that the 6-inch diameter drain pipe discharging from the west side of the outlet works discharge culvert wing wall into the dissipation pool area was flowing "mud". The date and time of this notification is not clear in the available

information but was likely sometime on the morning or early afternoon of March 11<sup>th</sup>, the day prior to the failure. This pipe normally did not flow water other than during periods immediately following significant rain. The amount of time that this condition (drain pipe flowing “mud”) had existed was not established during deposition. It may have been a few hours or perhaps several days to a week or more.

2. On Thursday afternoon, March 11<sup>th</sup>, the Maintenance Man went to the site and observed about 1-inch of water flowing from this pipe and described it as “muddy water”. The Maintenance Man notified the Owner who in turn notified the Engineer about 3:30 pm of the problem. The Maintenance Man left the site for the evening at about 5:00 pm. Depositions indicate that the Owner or Engineer did not visit the site prior to the Maintenance Man’s departure.
3. The Engineer confirmed he had received a phone call from the Owner and was informed of the observations of the Maintenance Man about the drain pipe discharge with a “slightly muddy tint”. The Owner was informed by the Engineer that it would not be unusual for some of the drains to have increased discharge due to the heavy and extended rainfall ending just a week or two prior to the incident. It was further reported that the Maintenance Man did not feel any soil or fines particles in the pipe discharge. The Engineer indicated he would visit the site the following morning.
4. The Engineer was on the way to the site on Friday when he received a call from the Owner about 8:30 am and was informed that the Maintenance Man reported that the drain discharge appeared to have a little soil material in it and had more of a muddy tint. The Engineer arrived at the site sometime between 9:00 and 9:30 am.
5. Upon arriving at the site, the Engineer noted that the reservoir pool was about 6 to 8 inches above normal and observed that the dissipation pool below the outlet discharge did have some muddy discoloration and that the discharge from the drain pipe had increased. Upon further inspection, the Engineer noted that there was a single point of seepage exiting the foundation at the ground surface immediately downstream of the dam toe, west of the wing wall, above the level of the dissipation pool, and away the location of the 6-inch drain pipe discharge. The discharge exiting the ground surface was described as about a ½-inch diameter flow bubbling about ½-inch above the ground surface. The Engineer estimated rate of flow to be ½ to 1 gallon per minute. There was minor evidence of soil particles (10 grains in one minute flowing over a fine screen) being transported in the discharge but there was no accumulation of sand material around the discharge area. The Engineer indicated that the flow from this discharge was traveling along the ground surface to the dissipation pool and that some of the water was infiltrating down through the relief drain materials and into the discharge pipe and causing the flow from the pipe.
6. The Engineer then proceeded to complete an inspection of the outlet discharge conduit that was flowing, the toe of the dam both east and west of the location of the outlet discharge structure, the dam crest, and the reservoir pool along the

upstream dam slope looking for any seepage, signs of distress, or whirlpools. None were noted. He went back to the seep and noting no change, left the site at 11:00 am.

7. The Maintenance Man called the Engineer at about 11:30 to 11:45 and noted that the flow from the 6-inch discharge pipe had increased. He then left the site to get lunch and returned to the seep area and noted a significant change in the seepage.
8. Although the timeline could not be established exactly, sometime around 12:00 to 12:15, the Maintenance Man described seepage from an area about 20 to 30 feet southwest of the drain pipe discharge location, muddy in color and spraying 30 to 40 feet into the air. He immediately contacted the Engineer who was just minutes from returning to the site.
9. Upon arriving back at the site, the Engineer described the seep as spouting approximately 2 to 3 feet in height and with a diameter of about 18 inches. He further noted that “Quite suddenly, the area around the boil appeared to liquefy and/or settle downward and rapid erosion set in to the north (*backslope of the dam*) and to the south (*downstream direction*)” (*italics are the authors*). The erosion into the downstream slope of the dam progressed quickly. During deposition, the Engineer noted that the location of this seepage was 10 to 15 feet off the backtoe of the dam, and about 60 to 70 feet off the “distilling” basin and west side of the box structure. We (the authors) interpret this location to be 10 to 15 feet downstream of the downstream toe of the dam. Seepage at a location like this would typically be associated with foundation seepage. However, as will be noted further below, the location of the toe drains and the 1999 remedial construction in the area around the outlet works discharge structure and box culvert, along with the potential for clogging of these drain systems could have substantially altered seepage patterns.
10. The Engineer noted that the crest of the dam had breached and uncontrolled release of the lake pool began at approximately 12:25 pm.

## **POTENTIAL FAILURE MODES FRAMEWORK**

### **Seepage Failure Mode Continuum**

Ferguson (2012) presented a seepage failure mode continuum built upon the system first described by Fell, et al (2003) and incorporated by the U.S. Bureau of Reclamation, in their Best Practices for Dam Safety Risk Analysis (2010). The continuum was published by Halpin and Ferguson in the ASDSO Journal of Dam Safety (2007), and also incorporated by the U.S. Army Corps of Engineers in Appendix O of ER 1110-2-1156 (2011).

The phases include 1) Initiation, 2) Continuation, 3) Progression, and 4) Breach Failure. Understanding these phases are fundamental to the assessment of seepage related failure modes, developing event trees and making estimates of the annual probability of failure used in risk analysis. Important characteristics of the Continuation and Progression phases are summarized below and are the basis for discussion and conclusions presented later in this paper.

- **Continuation:** Begins immediately following initiation and lasts for the period when the piping feature remains relatively small, when the rate of development and size of the erosion feature is controlled by erodibility, gradients, and the permeability of the material where the erosion is occurring. Primary assessment issues:
  - ✓ Continuity and erodibility of the layer where the pipe/erosion will occur,
  - ✓ Presence of roof forming materials that supports and sustains the development of the pipe/erosion feature without collapse that may disrupt the erosion process, and
  - ✓ Ability to sustain gradients that cause erosion at the active front (face) of the pipe/erosion feature.
  - ✓ Ability to sustain particle movement through the piping defect once the particle has dislodged from the active front.
  
- **Progression:** Begins immediately when a relatively small pipe/ erosion feature in the continuation phase breaks through to a high permeability material or water source that results in a significant increase in the flow volume and velocity in the pipe/erosion feature. The increase in flow volume and velocity causes gross enlargement of the feature:
  - ✓ Opening expands due to large flows
  - ✓ Collapse of overlying foundation and embankment soils occurs
  - ✓ Localized slope raveling and instability also begin to occur moving from the downstream toe area toward the crest of the dam.

### **Potential Failure Modes Around Conduits**

Using the general potential failure modes (PFM) framework described in the FEMA Technical Manual on Conduits Through Embankment Dams (FEMA, 2005), Ferguson (2012) outlined six specific that should serve as the starting point for any assessment of the seepage safety conditions around outlet conduits in embankments

- PFM #1 – Piping/erosion along backfill/conduit Interface
- PFM #2 – Piping/erosion along backfill/native soil or bedrock Interface
- PFM #3 – Piping/erosion into unfiltered defects in the conduit or related conduit structures/drain pipes
- PFM #4 - Piping/erosion through vertical or horizontal cracks developed through differential settlement and hydraulic fracturing processes
- PFM #5 - Piping/erosion as a result of a combination of the mechanisms identified in PFM's #1 through #4 above that combine to create a continuous pathway for the initiation, continuation and progression phases of the failure mode development process.

PFM #6 - General piping/erosion failure modes in embankment and/or foundation materials in areas adjacent to the outlet conduit that may combine with the failure mode processes associated with #1 through #4 above.

As will be discussed further below, PFM's #5 or #6 are the most likely failure modes of Big Bay Dam. Based on the work presented by Ferguson et al (2013), there is no indication that cracking or hydraulic fracturing (PFM #4) was a contributing factor. There does not appear to be a mechanism at the location of the conduit to have caused enough differential settlement for cracking or hydraulic fracturing to have occurred.

#### **ASSESSMENT OF AVAILABLE INFORMATION**

The process of assessing the failure began shortly after the breach occurred. Several investigators working for the owner and impacted third parties completed independent and collaborative investigations and evaluations. Details of these investigations are not included in the paper. Instead, we have extracted various pieces of information from these evaluations that assist with the assessment of the failure from a failure modes perspective.

The approximate location where the failure mode breakout occurred, based on deposition by both the Maintenance Man (Daughdrill deposition, p 69, October 3, 2006) and the Engineer (Burge deposition, p 208, December 17, 2007) along with the location where several important initial borings were completed (Eustis, 2004) in the remnant embankment adjacent to the breach location are illustrated on Figure 4. You will note that the original outlet works conduit is shown on the original plan view along the bottom of this figure at a location that is approximately near the center of the final breach configuration. The outlet works intake structure, conduit, and discharge structure were completely destroyed during the breach formation process leaving no remnant structure or embankment/foundation materials available for forensic evaluation.

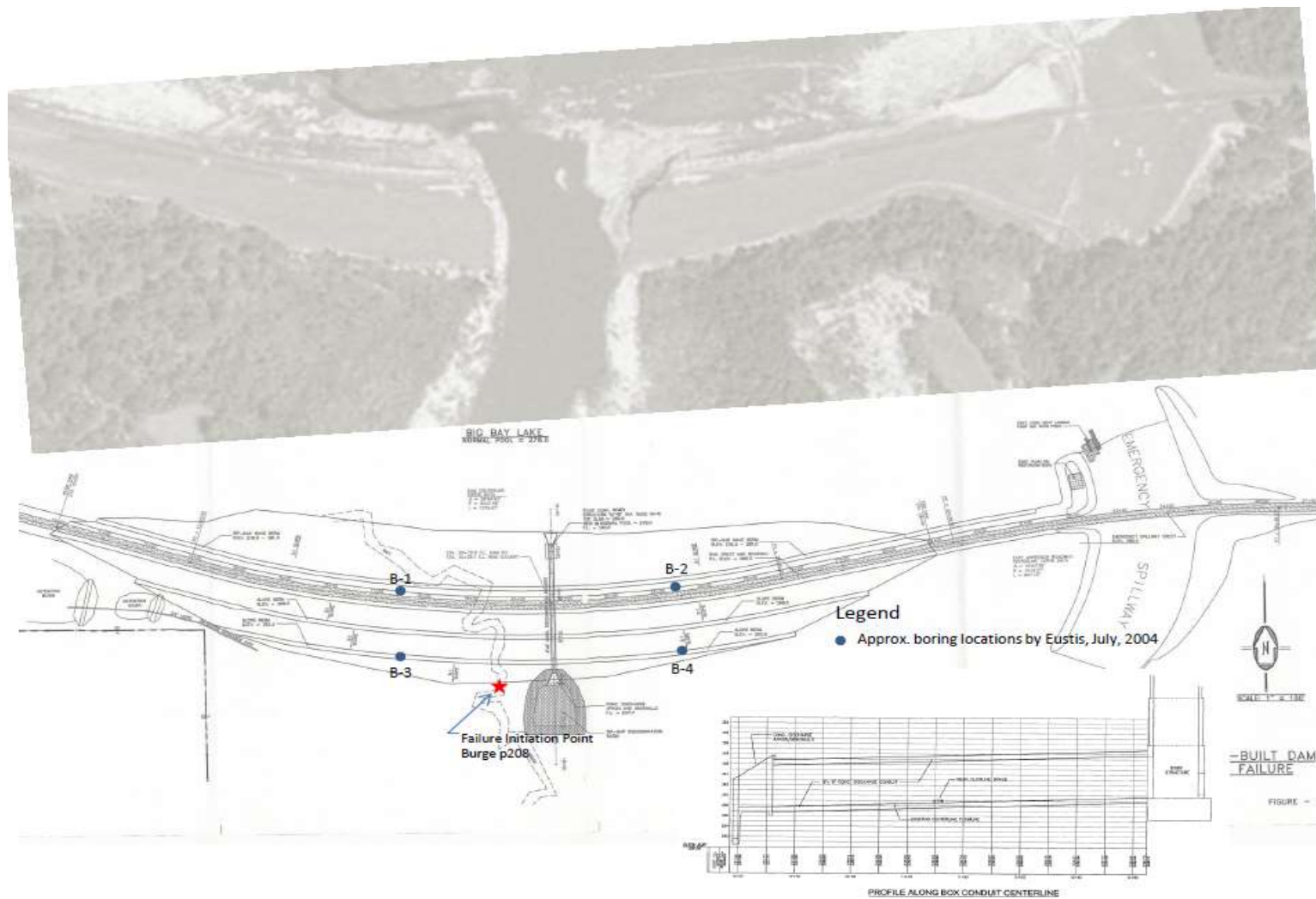

Figure 4. Plan View of Failure Showing Approximate Location Where Failure Mode Breakout Occurred and Original Borings Were Performed





In addition to representing the foundation soils, it is suspected that this gradation may also represent some if not a large portion of the soils used to construct the embankment dam upstream and downstream of the cutoff wall and may also represent materials used for the cutoff wall prior to the addition of bentonite. In general, the soils at the site are relatively poorly graded fine sand with some silt and clay fraction along with minor amounts of fine gravel. Over 75 to 80 percent of the material consists of sand between 0.1 and 0.6 millimeters in size.

The central portion of this figure shows the “critical velocity” required to initiate erosion along the bottom of canals and waterways as estimated by Jean-Luis Briaud and presented in 2007 at the 9<sup>th</sup> Peck Lecture. While the gradational scales on the lower axis of the two upper exhibits in this figure are inverted to one another, they have been sized and positioned approximately at the D50 particle size so that the overall gradation and critical velocity can be compared. As can be seen, the materials at the site would classify as very highly erodible. The lower portion of this figure shows a similar phase diagram first published by Hjulstrom (and others) in the early to mid 1930’s on the piping, erosion and deposition of soils. The range of gradation of the foundation soils have been indicated by the labeled arrows and further confirm the highly erodible characteristics of the soils at the site. Such data strongly suggests the need for adequate filter and drainage systems in the dam to protect against piping and erosion. The designs did not include a filter diaphragm around the outlet conduit, or an adequate toe drain system, two provisions that were common practice at the time this dam was design and constructed. From an overall risk perspective, the lack of these provisions would significantly increase the probability of the development of distress indicators and dam failure.

## 2. Central Core – lack of full cutoff, and defects in construction

The second significant finding of our review is related to the primary seepage control provisions of the design. The original design called for a cutoff wall to be installed immediately upstream of the centerline axis of the dam, and a small toe trench drain just under the downstream toe of the dam. A representative cross-section of the dam showing the design location of these features is illustrated on Figure 7. We will return to this figure for a discussion of various distress indicators in a later subsection. The cutoff wall was to be constructed by adding bentonite to the typical soils at the site in order to reduce the permeability by two or more orders of magnitude over the embankment soils in the rest of the dam along with the upper Bay Creek Basin Alluvium foundation soils.

The locations of several post failure forensic borings are shown on Figure 4. A number of representative gradation curves for materials in, and below the cutoff wall are shown on Figure 6, and a summary of laboratory test results of gradation and permeability of various samples is provided in Table 1. The blue highlighted rows in Table 1 represent the four sample gradation curves shown on Figure 6. The light burgundy colored cells in the table highlight the permeability test results of the samples taken from the cutoff wall.

A fence diagram of boring results summarizing the foundation subsurface profile upstream of the planned cutoff wall location is shown on Figure 8.

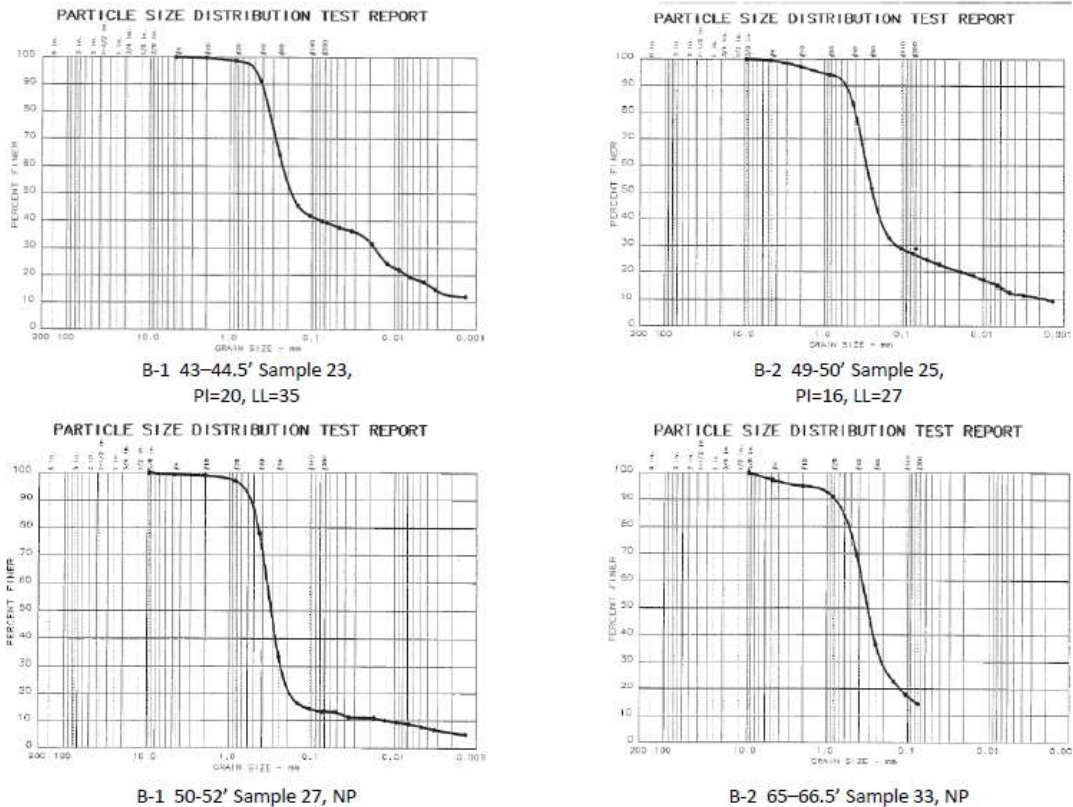

Figure 6. Example Gradation Curves for Embankment and Foundation Materials

We have added two lines to this figure showing the estimated bottom of the cutoff wall, and the approximate location of the top of the “older cohesive soils” at the site. As can be seen from the permeability results in Table 1, the upper foundation soils of the Bay Creek Basin Alluvium have permeability in the range of  $10^{-3}$  to  $10^{-4}$  whereas the “older cohesive soils” have permeability in the range of  $10^{-8}$  to  $10^{-9}$  range. The location where the breach occurred is generally indicated along the top of this figure. Comparing these two lines shows that a six- to ten-foot-thick “window” of higher permeability foundation soil was left below the cutoff wall. This window is a significant contributing factor to a potential failure mode development process as will be seen later in seepage analysis results.

In summary, data gathered following the dam failure indicates that the cutoff that was constructed did not fully penetrate the moderate to highly permeable shallow foundation soils. Older cohesive foundation soils with very low permeability are located at reasonable depth beneath the site. A complete cutoff system could have been achieved if the cutoff had been installed into this layer of “impermeable” foundation materials. In addition to this deficiency in the design and construction, the subsequent investigations of the cutoff wall summarized in Table 1 indicate that the permeability of the “cutoff” materials was variable by up to three orders of magnitude with the higher values providing “windows” that would allow for the development of preferential seepage pathways.

Table 1. Results of Laboratory Testing - Embankment "Cutoff" and Foundation Soils  
Eustis Engineering, 2006

Boring No.	Sample No.	Depth (feet) (note 3)	Classification	Est. Initial Void Ratio	Coefficient of Permeability (cm/sec)	Comment
B-1	7	11 - 12.5	Clayey sand with trace of gravel (SC)	0.394	3.7 x 10 <sup>-6</sup>	Test of "Cutoff" material
	13	23 - 24.5	Clayey sand with trace of gravel (SC)	0.434	5.8 x 10 <sup>-4</sup>	Test of "Cutoff" material
	17	31 - 32.5	Sandy clay with trace of coarse sand (CL)	0.447	1.0 x 10 <sup>-5</sup>	Test of "Cutoff" material
	23	43 - 44.5	Clayey sand (SC)	0.34	1.5 x 10 <sup>-7</sup>	See Figure 6 for gradation, test of "Cutoff" material
	27	50 - 52	Clayey sand (SC)	0.509	4.3 x 10 <sup>-4</sup>	See Figure 6 for gradation
	31	63 - 64.5	Fine sand with clay, gravel and trace of coarse sand (SP-SC)	0.307	3.0 x 10 <sup>-5</sup>	Foundation soil below "Cutoff"
B-2	7	11 - 12.5	Clayey sand with vertical sand layer and gravel (SC)	0.407	2.0 x 10 <sup>-4</sup>	Test of "Cutoff" Material
	11	19 - 20.5	Clayey sand with trace of gravel (SC)	0.448	3.3 x 10 <sup>-6</sup>	Test of "Cutoff" Material
	15	27 - 28.5	Clayey sand with fine sand layer (SC)	0.398	4.5 x 10 <sup>-5</sup>	Test of "Cutoff" Material
	21	39 - 40.5	Clayey sand with gravel (SC)	0.405	3.3 x 10 <sup>-5</sup>	Test of "Cutoff" Material
	25	49 - 50	Clayey sand with gravel (SC)	0.446	2.2 x 10 <sup>-5</sup>	See Figure 6 for gradation, test of "Cutoff" material
	33	65 - 66.5	Clayey sand with trace of gravel and coarse sand (SC)	0.537	3.2 x 10 <sup>-3</sup>	See Figure 6 for gradation, foundation soil below "Cutoff"
	38	75 - 76	Silty clay with clay layer (CL)	0.628	8.2 x 10 <sup>-8</sup>	Older cohesive soils
B-3	13	59 - 60	Clay (CH)	0.682	1.9 x 10 <sup>-9</sup>	Older cohesive soils

- Notes: 1. cm/sec = centimeters per second  
2. (SC) indicates soil classification by the Unified Soil Classification System  
3. Top elevation of boring B-1 was 281.8, and boring B-2 was 282.8 at the time of drilling.

3. Downstream filters/drains – locations and dimensions inadequate to control seepage, and method of construction would have resulted in clogging

As noted above, a very limited downstream filter and toe drain was included in the original design and construction work. After first filling of the reservoir, a number of seepage distress areas developed along the downstream toe for the dam and at the location of the outlet works conduit and discharge structure. Remedial designs and construction of repairs at these locations were completed.

Two important seepage design and subsequent seepage repairs may have significantly contributed to the failure mode development process. First, the small toe drain system installed as part of the original construction and as part of several remedial actions were constructed with a method that would likely contribute to clogging of the drain over time. This is illustrated by the typical drain detail shown on Figure 9. A photograph of the typical installation of a toe drain is also shown on this Figure. You can see in the construction photo that the filter fabric was draped over the vertical sides of the excavation and there are numerous bubbles and very poor installation techniques that were used. This method of installation would not result in intimate contact between the filter fabric lining the trench and the adjacent foundation soils. This would allow soil particles from the soil face to move as seepage water exits from the foundation soils and flows into the drain. Over time, instead of acting as an effective filter/drain protecting the foundation and embankment materials from erosion by collecting and safely discharging foundation and embankment seepage, the filter fabric around the exterior of the drain would have clogged. A clogged drain could result in the localized increase of water pressures in the downstream toe area and a breakout of seepage at an unfiltered and/or uncontrolled location. It is also interesting to note the apparent tear/opening in the filter fabric in the lower right hand area of the photo. Such defects, combined with the possibility of clogging in other areas could result in the initiation of piping into the drain during later stages of the failure mode development process as described in items 1 and 2 of the failure mode description above.

Similarly, in 1999 a significant amount of seepage was observed discharging from the area around the outlet conduit discharge structure. At this time, a significant excavation along the conduit was completed. Details of this design and construction are very limited and allow for only a cursory evaluation related to potential seepage failure mode development. It is not known if filter fabric was used in this repair. However, based on the characteristics of the other seepage toe drain collection details, the use of filter fabric is likely. Based on the other filter fabric installations and concerns, we believe that there is some reasonable likelihood that this fabric would have also clogged and stopped functioning over time. A clogged drain at this location could also have contributed to a localized increase in water pressures, development of concentrated seepage flows and gradient around the repair area, and the possibility of a seepage breakout at an unfiltered/uncontrolled location near the outlet discharge structure.

The approximate location and limits of the excavation and filter/drain construction around the end of the conduit is illustrated on the cross-section shown along the outlet conduit on Figure 7. Information from the deposition of one of the original design engineers and the person that was responsible for dam safety monitoring at the time of construction is as follows:

“In August of 1999, the owner reported that the back slope area immediately adjacent to the discharge box downstream wingwalls and headwall were exhibiting high moisture conditions, and instructed us to evaluate and implement necessary measures. Excavations were made along the fill side of the wingwalls and along the box sidewalls for approximately 50’ into the lower berm back-slope. One of the lower berm relief drains (installed August of 1993 that passed over the discharge box, was encountered and found to have had its carrier pipe crushed and pinched off. This prevented its collected water from being transported to the relief toe drain. The trapped water was saturating down into the permeable backfill along the box sidewall and eventually percolating to the surface in the lower portions of the slope along the wingwalls and box sidewall. Upward percolation of ground water was also observed in this area around the headwall and wingwall.”

“It is our opinion that the weep in this area is not stopped up and it is not a toe drain. If you remember the condition I reported to you on the phone, that we discovered a wet area two to three years ago. After digging into the ground above the box, a large zone of saturated soil was discovered. We built a very large gathering system at the end of the box and the pipe that you see is draining it. The pipe did run for approximately two months after installation, then quit. It has never drained anything since then, nor has the ground been wet. The installation of the rock and the ground around the end of the box has been noted on the plans and *the Engineer* will get you the information as to this construction.” (*Italics are the authors*)

#### **Distress Indicators**

A number of significant distress indicators were present at the site beginning just after the first filling and continuing until the dam breached. The approximate locations and descriptions of these distress indicators are illustrated on Figure 7 and summarized below.

#### 4. Significant leaks through defects in outlet conduit

Information in the project record indicates that there were many locations where leakage was occurring into the outlet conduit once the reservoir filled. The characteristics of these leakage locations apparently changed over time. However, the two primary seepage locations indicated as distress locations 1 and 2 appeared to develop and flow for an extended period of time including the time of the July, 2002 inspection by the State Engineer. A photo of the downstream leak approximately 110 feet into the conduit from the discharge wing wall is shown on Figure 10. The discharge from the leak located near the upstream end of the conduit (254 feet from the discharge wing wall) was described as three discharges beginning about 10 inches above the box floor along the west wall.



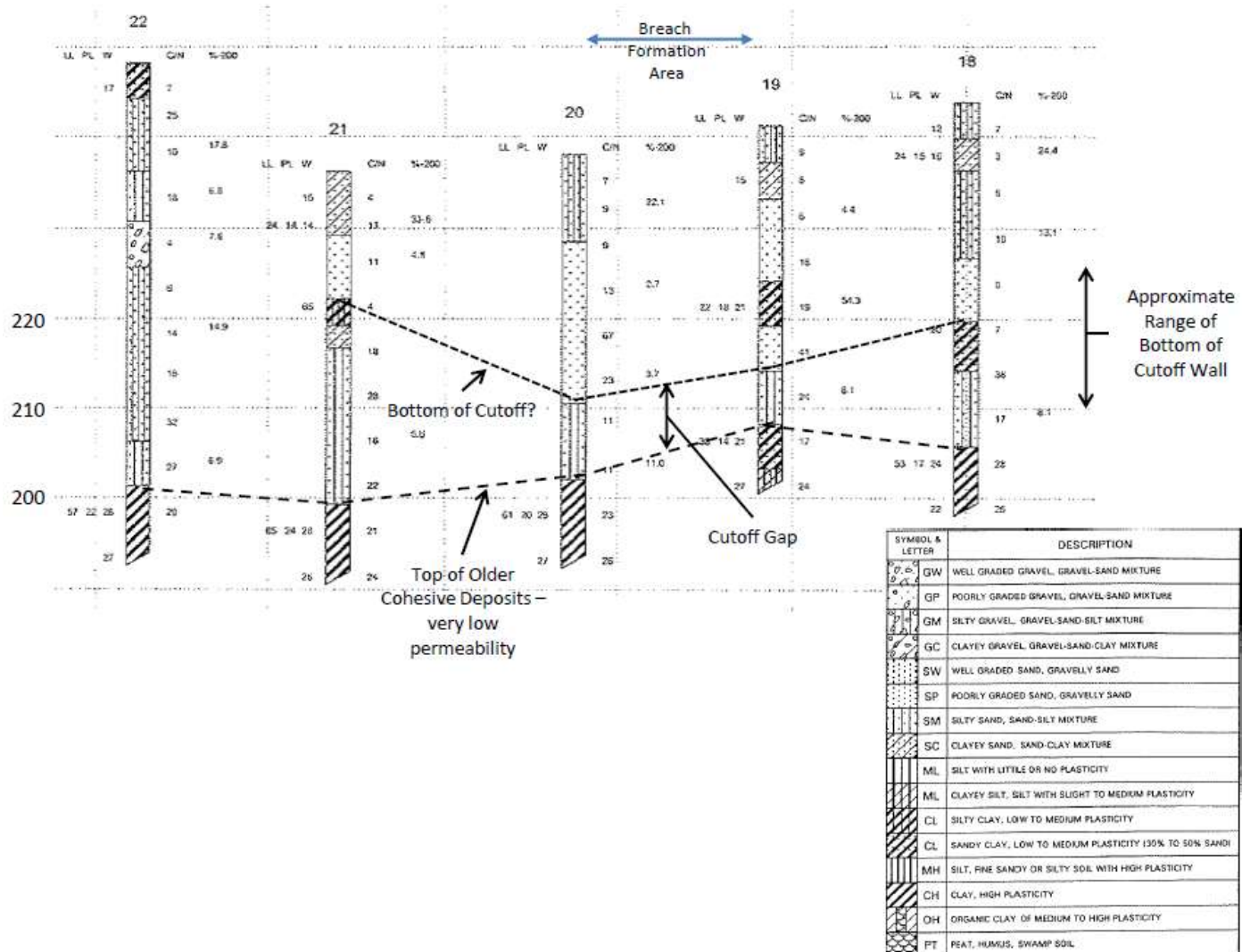

Figure 8. Estimated Bottom of Cutoff in Breach Formation Area



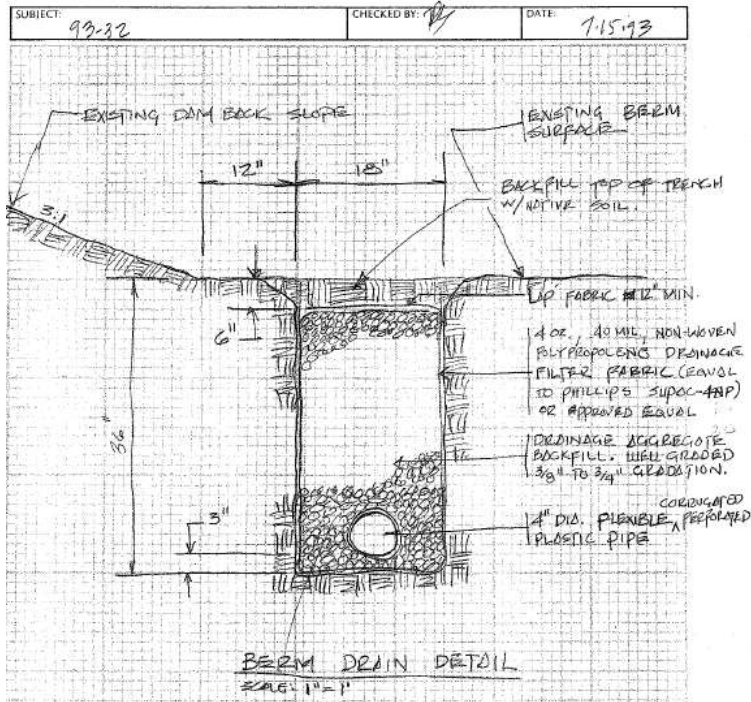

Figure 9. Typical Trench Drain Design Detail and Construction

The seepage ranged from a trickle to  $\frac{1}{4}$  to  $\frac{3}{8}$ -inch stream with total flow of about 5 to 6 gallons per minute. The seepage described at both locations would be sufficient to carry the substantial majority if not all of the material sizes of embankment and foundation materials indicated on the gradation curves provided on Figure 6.

5. Sinkhole on downstream slope of dam

A sinkhole was discovered on a lower bench along the downstream slope of the dam. This sinkhole had been backfilled by the time of the State Engineer inspection in July 2002. Maintenance personnel indicated that the sink hole was over the top of the outlet conduit while the Engineer noted during deposition that it was located 30 to 50 feet east of the conduit. A photo of the backfilled sinkhole is shown on Figure 11. The possible locations of the sinkhole are illustrated on Figure 7. A circle with the number 3 is shown at the two possible bench locations described in the depositions.



Figure 10. Photo of Leak Discharging into Conduit Approximately 110 Feet from the Outlet Wingwall. See Figure 7 for Approximate Location on Cross Section.

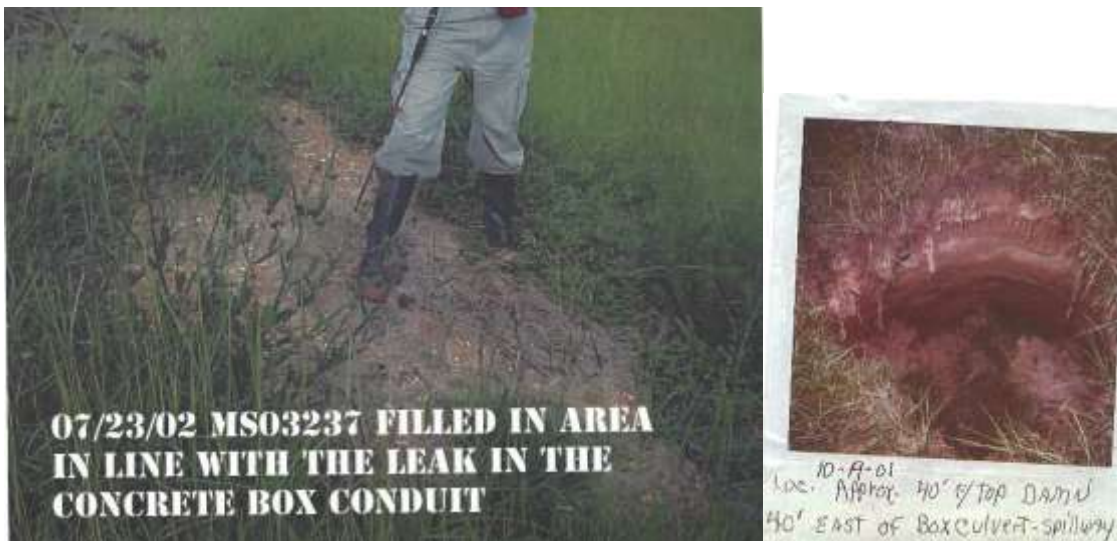

Figure 11. Photo of Sinkhole Before and After Backfilling on the Lower Downstream Slope Bench. See Figure 7 for Approximate Location on Cross Section.

## 6. Sinkhole of upstream slope of dam

While inspecting various documents and photographs as part of this project review, a picture of a sinkhole on the upstream slope of the dam below the high water line and just outside the breach limits was discovered. A picture of this sinkhole is shown on Figure 12. While a bit unusual to be this far from the outlet conduit, there are no other identifiable conditions that could have led to its formation other than the potential failure mode associated with the outlet conduit. It is possible that several of these sink holes could have formed over the life of the structure with a different one being the primary failure mode pathway.



Figure 12. Photos of Sinkhole on Upstream Slope of Dam Following Breach Development. See Figure 7 for Approximate Location on Cross Section.

## 7. Terminal outlet works pool filled with sediment

The following information was presented in the 2002 inspection report by the Engineer. The amount of silt material in the discharge pool is conspicuous. While some of this material may have been the result of surface erosion and drainage, this is also the first location downstream of the outlet conduit where any material eroding through defects in the conduit would have had sufficient resident time to settle and accumulate.

“During this repair, the rip-rap dissipation pool was observed to have silted in and lost its hydraulic efficiency due to rock displacement over the prior years of flow activity. The owner ordered restoration of the pool. This was accomplished by excavation of the silted materials, reshaping of the pool profile and section, and placement of additional and larger stones at appropriate locations throughout the pool area.”

### DESCRIPTION OF POTENTIAL FAILURE MODE

As summarized above, a number of the site conditions, design and construction details, and the distress indicators that developed between the initial reservoir filling and failure combine to suggest a potential failure mode development process. Based on the Author’s evaluation of available information, and experience, we believe an eight node system response event tree could be used to both describe and estimate the annual probability of failure of the “as constructed” outlet conduit/embankment dam at the location where the breach occurred:

1. Reservoir is maintained at a relatively constant “full” level allowing steady state seepage conditions to develop relatively rapidly, and to be maintained over an extended period of operation
2. A continuous preferential seepage pathway can develop through a combination of continuous layers, stress reduction zone along the conduit, along the base of the conduit, through defects in the embankment cutoff wall, and in the upstream shell of the embankment
3. Conditions along the continuous seepage pathway supports the development of a roof and/or maintenance of the erosion process
4. Seepage daylight to an unfiltered exit
5. Backward erosion and piping initiates
6. Erosion pipe advances back to the reservoir
7. Intervention is unsuccessful
8. Breach by progression and gross enlargement and release of the reservoir

It should be noted that steps 4, 5, and 6 likely developed over at least three to 4 cycles beginning at the open defects in the conduit near the upstream riser structure. **Cycle 1** - Gradients, flow quantities and the relatively short distance between the reservoir and this location (distress location 2 shown on Figure 7) would have allowed an open erosion/piping feature to develop between the reservoir and defects through the upstream slope of the embankment or at the contact between the embankment and foundation. Several such features may have developed over time and they may have become fairly large through progression mechanisms associated with the backward piping and erosion process leading to the formation of sink holes similar to that shown in Figure 12. **Cycle 2**

- Once the cycle 1 continuation process completed and an open pathway(s) developed in the upstream shell or foundation, water pressures in the embankment and foundation could have changed, locally altering the water pressures and gradients from that point to other defects in the conduit further downstream such as distress location 1 shown on Figure 7. This would have allowed initiation and/or continuation mechanisms eventually leading to the development of an open defect (pipe) under the central portion of the embankment section. As the flows in the open defect slowly increased over time, there may have been conditions suitable for sinkhole formation up through the shell of the dam as shown as distress indicator 3 on Figure 11.

**Cycle 3** – Based on the information available, we believe that the most likely next (third) cycle would have been between distress location 1 (Figure 7) and a defect in the embankment toe drain system. As water pressures in the foundation locally changed in response to the open defect extending to the area under the downstream shell of the dam, the amount of seepage and the corresponding seepage gradients occurring around the filter drain system that had been installed around the downstream end of the conduit, and in the toe trench drain could have locally increased. Because of the method of construction of these systems at the dam, there would have been a high likelihood of clogging, creating a localized “confining” layer and/or seepage barrier that would have forced seepage through the foundation materials into any defect of the toe drain, and perhaps exiting other areas of the foundation just downstream of the toe of the dam. Any unfiltered and localized defect such as a tear in the toe trench drain filter fabric would be the most likely candidate location for this cycle of initiation, and backward erosion/piping to develop. **Cycle 4** - Once the third cycle completed, and a relatively open defect existed between the reservoir and the downstream toe drain system, large pressures and gradients could have locally developed in the foundation area immediately downstream of the embankment toe leading to the cycle 4 initiation and continuation of an unfiltered piping defect over the relatively short distance between the concentrated leak described under item 5 of the failure mode event summary, and the open defect immediately upstream of the clogged toe drain trench. Once the continuation phase of that erosion cycle was complete, a relatively open pathway from the reservoir to the downstream defect toe could have existed resulting in the conditions described in the later stages of the failure mode events, and very rapid progression (gross enlargement) of the pipe, and breach formation.

During Cycle 3 described above, the amount of seepage, water pressures and gradients occurring around the filter drain system that had been installed around the downstream end of the conduit, and in the toe trench drain would have been relatively complex. Because of the method of construction of these systems at the dam, as previously noted there would have been a high likelihood of clogging, creating a localized “confining” layer and/or seepage barrier that would have forced seepage through the foundation materials into any defect of the toe drain, and perhaps exiting other areas of the foundation just downstream of the toe of the dam. Any unfiltered and localized defect such as a tear in the toe trench drain filter fabric would likely been a candidate location for initiation, and backward erosion/piping to develop. Once the continuation phase of that erosion cycle reached the open erosion pipe at downstream conduit defect (distress location 1), an open channel from the downstream toe of the embankment to the reservoir

would have existed. As the continuation phase completed, we would expect that high water pressures associated with a completed piping/erosion pathway would have caused the type of “spraying 30 to 40 feet in the air” described by the Maintenance Man with the pipe rapidly opening due to the highly erosive nature of the foundation and embankment soils. It is also conceivable, that the relatively rapid transmission of high water pressures to the downstream toe area could have resulted in the localized “liquefaction” described by the Engineer as water literally exploded out of the continuous open piping feature between the reservoir and the downstream toe. The progression phase would have likely been very rapid under this failure development sequence.

### SEEPAGE MODEL OF POTENTIAL FAILURE MODE

To help inform this assessment of the conditions and events leading to the failure of Big Bay Dam described above, a generalized 2-dimensional (2-D) seepage model was created and a series of stepwise models were run. The models were created with SEEPW (Geo-Slope International, Ltd, version 8.12). Each step in the modeling process represents one in the series of events that we believe describe the most likely failure mode development process described in the preceding section. A cross-section of the dam at the outlet works annotated to indicate the locations where each step was added to the model along with the locations where both seepage quantities and gradients were identified and assessed (assessment points A through F) is shown on Figure 13. A summary of the permeability values assumed in the model is provided in Table 2.

Table 2. Summary of Permeability Values Assumed in Seepage Models

Material	Assumed Permeability cm/sec (ft/day)
Embankment/Foundation Cutoff Wall (Base Case 1)	$1 \times 10^{-6}$ ( $2.8 \times 10^{-3}$ )
Embankment/Foundation Cutoff Wall (Base Case 2)	$1 \times 10^{-4}$ (.28)
Embankment Shells	$1 \times 10^{-3}$ to $1 \times 10^{-4}$ (2.8 to .28)
Bay Creek Basin (upper) Alluvium	$1 \times 10^{-3}$ to $1 \times 10^{-4}$ (2.8 to .28)
Older Cohesive Deposits	$1 \times 10^{-7}$ ( $2.8 \times 10^{-4}$ )

Notes: cm/sec = centimeters per second  
ft/day = feet per day

We recognize that seepage conditions around the conduit were really 3-dimensional (3-D) and the use of a 2-D model neglects significant 3-D influences on the failure mode development process. For example, our previous efforts to model a seepage defect (Ferguson, 2012, and Ferguson et al, 2013) suggest that a 2-D seepage model likely underestimates seepage gradients at the active erosion face of a developing seepage defect (pipe), and significantly underestimates seepage quantities (by several orders of magnitude) through developing defects. Hence, any general results and corresponding conclusions from a 2-D model would likely be conservative. By conservative, we mean

that the results would under estimate the potential for the failure mode to initiate, and move through the “continuation” phase of development.

The steps in the modeling process are summarized below.

Step 1 – Two separate models have been run representing the range of possible “cutoff” wall permeability in the vicinity of the outlet conduit. The first model (Base Case 1) assumes that the “cutoff” was constructed as designed with a permeability of  $1 \times 10^{-6}$  cm/sec. The second model (Base Case 2) assumes that the “cutoff” was constructed with a permeability of  $1 \times 10^{-4}$  cm/sec. These two cases represent the “boundary” condition of permeability values determined in post failure laboratory tests shown in Table 1. The lack of full penetration to the “Older Cohesive Deposits” was included in both cases. No conduit defects are included in these models. In addition, the nominal toe drain system was also neglected due to its very limited dimensions, and poor construction that would have reduced or limited its function over time. The results of these models represent the idealized conditions that would have existed as the embankment and foundation reached a steady state seepage condition following first filling. It should be further noted that both Base Case 1 and Base Case 2 were run for each of Steps 2 through 8 described below. In addition to the models at the conduit cross-section, models representing the Base Case 1 and 2 conditions at an adjacent location through the embankment and foundation without the conduit were run and compared to the results of the model at the conduit cross section.

Step 2 – During this step, the defects into the outlet conduit were opened in various sequences along both the top and bottom of the structure at the two primary locations observed and indicated as distress locations 1 and 2 on Figure 7.

Step 3 – The top and bottom defects at the upstream end of the conduit are connected with an open seepage pathway.

Step 4 – A partial open seepage pathway extending from the top upstream defect toward the upstream slope of the dam is added. This is consistent with the observed sink hole on the upstream face of the dam shown on Figure 12. It is the author’s opinion that such a defect and open seepage pathway developed rather quickly after the first filling of the reservoir due to the gradients, seepage quantities flowing through the conduit defect, and the highly erodible nature of the embankment and foundation soils at the site. Seepage conditions estimated by the model at the upstream end of the partially open pathway feature will help identify conditions capable of sustaining the erosion process under this step in the failure mode development process. Note that for the final seepage model, this step was modeled in two increments; 4a, and 4b.

Step 5 – A fully open seepage pathway is established between the reservoir on the upstream slope of the dam and the upstream open defects in the conduit. This pathway would have provided a significant reduction in the overall seepage pathway length in the dam foundation and could result in significant localized changes in the water pressures in the embankment and in the foundation if the “cutoff” permeability was relatively high. The seepage model results may help understand the kinds of

changes that occurred in water pressures and gradients if an open erosion feature develops and changes to the seepage gradients at conduit defects further downstream.

Step 6 – A seepage defect is opened a partial distance from the downstream distress location 1 located 110 feet from the end of the conduit toward the location of the cutoff wall. This is the location where erosion of foundation materials could have initiated and provided the pathway for continuation of erosion along the base or lower sides of the conduit back toward the upstream open defect and the reservoir. This step will help identify whether or not seepage conditions in the area between the two primary defects would have been sufficient to “continue” (sustain) the erosion process.

Step 7 – The seepage erosion feature along the base of the conduit is opened through the zone of the cutoff wall (7a), and then completely from the downstream to the upstream conduit defects (7b) allowing for transmission of relatively large water pressures from the reservoir to a location under the downstream shell of the dam.

Step 8 – At this time, it is assumed that the construction work along the downstream end of the conduit had been completed and that there had been enough time for seepage to have moved particles and clogged this filter along with the filter fabric lining the toe trench drain. This step in the modeling process will help to identify whether or not water pressures and seepage exit gradients at the downstream toe of the dam would have been sufficient to initiate, continue and cause the final events in the failure mode development process described in a preceding section by both the Maintenance Man and Engineer.

Some initial results of the seepage modeling are shown on Figures 14 through 22 below and summarized in Table 3. Only a portion of the seepage modeling results is presented on these figures and in this Table. A more comprehensive presentation of the modeling results will be part of a future paper on this case history.

We begin by examining the results of the seepage modeling of Step 1 and Base Case 1 (with cutoff wall) at the cross-section of the embankment and foundation immediately adjacent to the conduit. These model results represent the seepage conditions that would have been expected for the as-designed condition without the influence of defects in either the cutoff wall or conduit and neglecting any consideration of the nominal toe drain system or the seepage remediation constructed around the downstream end of the conduit in 1999. Equipotential lines and seepage gradient contours for these conditions are shown on Figures 14 and 15. The equipotential lines on Figure 14 show the influence of foundation seepage through the “window” beneath the cutoff wall that would have occurred. If the cutoff wall had been extended into the low permeability older alluvium at the site, the phreatic surface within the embankment would be substantially lower than indicated on this Figure. The phreatic surface that is shown is the result of “mounding” of seepage from the foundation up into the embankment that is typical when incomplete or defective cutoffs are installed. The total estimated seepage through this cross-section is about 0.02 gpm per foot of embankment. This corresponds to about 2 gpm per 100 feet of embankment. Significant defects in the cutoff wall could impact several important aspects of seepage within the dam and foundation that are difficult to simulate in a 2D seepage model: 1) localized increases in the phreatic surface, 2) slightly increasing



seepage quantities, and 3) increasing seepage exit gradients at the toe of the embankment and from the foundation immediately below the toe of the dam.

The seepage gradient contours along the cross-section including the downstream toe area are shown on Figure 15. The maximum seepage exit gradient occurs where seepage exits from the foundation immediately below the toe of the dam (location A). This would be the expected result from the partial foundation cutoff. The model suggests a maximum exit gradient that is about 0.4. This gradient is colored a cautionary yellow in the upper portion of Table 3. While it is lower than “critical” for these materials suggesting that general gradients would be less than necessary to initiate erosion along the toe of the dam, this gradient is high enough to indicate the need for a well designed and constructed embankment/foundation drainage system to account for potential geologic and construction defects, and produce an adequate level of seepage safety for the structure. When the cutoff wall is eliminated from the model, the estimate maximum seepage exit gradient at the surface of the foundation immediately below the downstream toe of the dam increases to 0.6. This high exit gradient has been colored red in the lower portion of Table 3 as it indicates inadequate margin of safety and a high likelihood of seepage distress area development associated with minor geologic or construction anomalies.

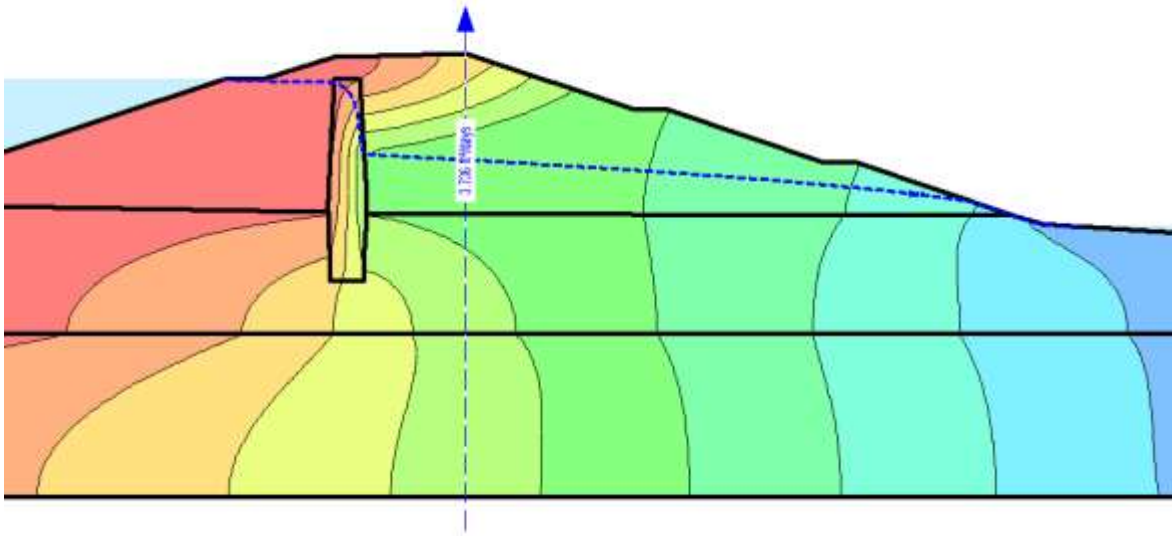

Figure 14. Equipotential Lines for Step 1, Base Case 1, Embankment Adjacent to Conduit

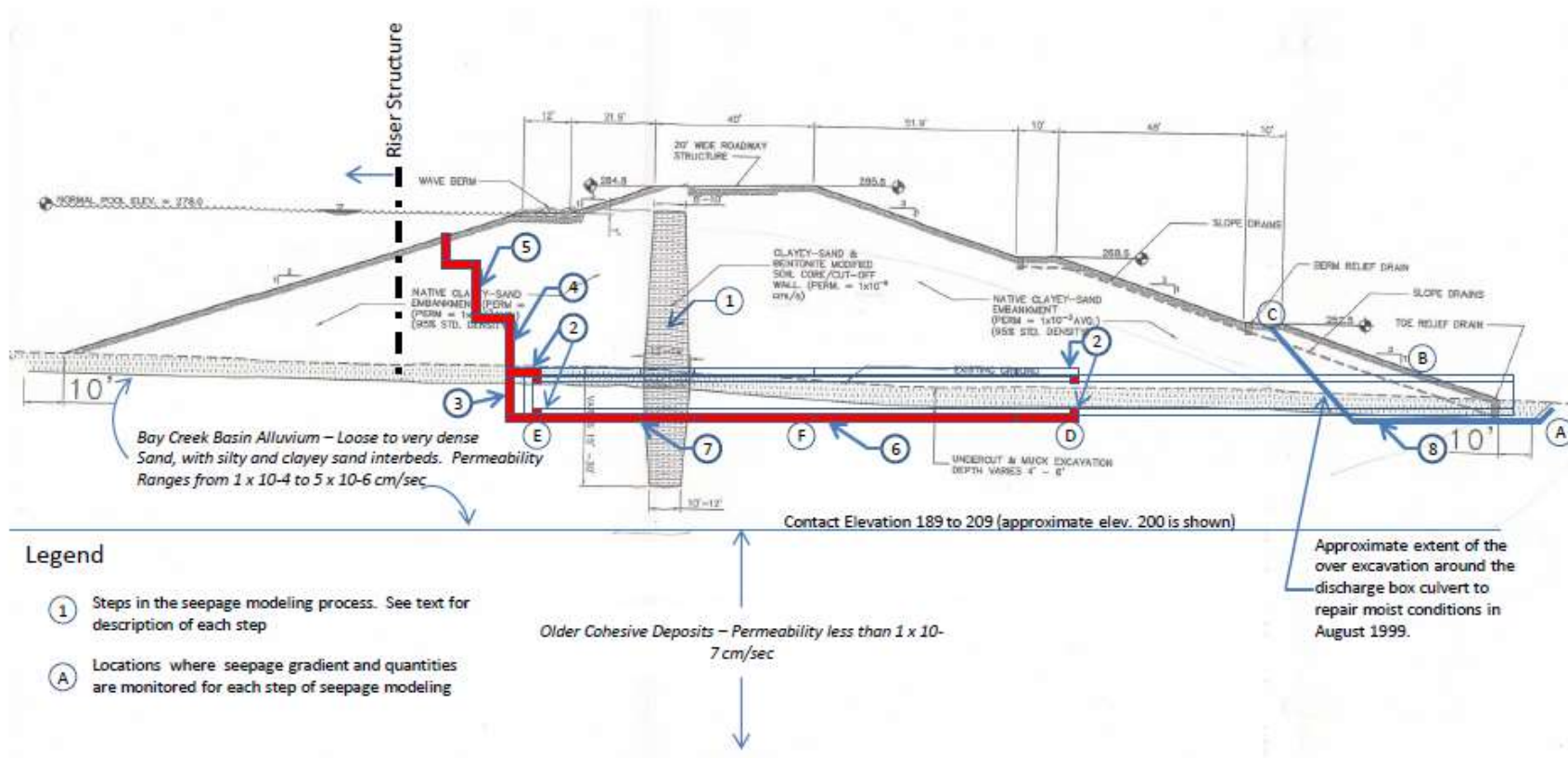

Figure 13. Cross-section of Dam and Outlet Conduit Showing Seepage Modeling Steps 1 through 8 and Model Result Evaluation Locations A through F

Table 3. Summary of 2-D Seepage Model Results, Steps 1 through 8, Assessment Points A through F

Cutoff Present (Base Case 1)

Failure Mode Step	Assessment Point A		Assessment Point B		Assessment Point C		Assessment Point D		Assessment Point E		Assessment Point F	
	Gradient (1)	Flow (gpm/ft)	Gradient (1)	Flow (gpm/ft)	Gradient (1)	Flow (gpm/ft)	Gradient (1)	Flow (gpm/ft)	Gradient (1)	Flow (gpm/ft)	Gradient (1)	Flow (gpm/ft)
1.	.4	.0073	0.3	0.0005	0	0						
2.	.1 to .4	.0073	N/A	N/A	N/A	N/A	10.6	0.0037	42.4	0.0108	0.10	0.0041
3.	.1 to .4	.0073	N/A	N/A	N/A	N/A	6.7	0.0024	0.4	0.0302	0.05	0.0020
4a.	.1 to .4	.0073	N/A	N/A	N/A	N/A	6.7	0.0024	0.4	0.0328	0.05	0.0020
4b.	.1 to .4	.0073	N/A	N/A	N/A	N/A	6.7	0.0024	0.4	0.0330	0.06	0.0021
5.	.1 to .4	.0073	N/A	N/A	N/A	N/A	6.9	0.0024	0.5	0.0351	0.06	0.0021
6.	.1 to .4	.0073	N/A	N/A	N/A	N/A	N/A	0.0043	0.5	0.0344	> 0.4	0.0034
7a.	.1 to .4	.0073	N/A	N/A	N/A	N/A	N/A	0.0047	0.5	0.0341	> 0.4	0.0038
7b.	> .4	> .0073	N/A	N/A	N/A	N/A	N/A	0.0032	N/A	0.0370	N/A	0.0022
8 (3)	> .5	> .0073										

Cutoff Not Present (Base Case 2)

Failure Mode Step	Assessment Point A		Assessment Point B		Assessment Point C		Assessment Point D		Assessment Point E		Assessment Point F	
	Gradient (1)	Flow (gpm/ft)	Gradient (1)	Flow (gpm/ft)	Gradient (1)	Flow (gpm/ft)	Gradient (1)	Flow (gpm/ft)	Gradient (1)	Flow (gpm/ft)	Gradient (1)	Flow (gpm/ft)
1.	.6	.0091	0.3	.0005	0	0						
2.	.02 to .2	.0091	N/A	N/A	N/A	N/A	11.2	0.0039	41.5	0.0106	0.12	0.0044
3.	.02 to .2	.0091	N/A	N/A	N/A	N/A	6.9	0.0046	0.4	0.0290	0.06	0.0038
4a.	.02 to .2	.0091	N/A	N/A	N/A	N/A	6.9	0.0028	0.4	0.0325	0.06	0.0023
4b.	.02 to .2	.0091	N/A	N/A	N/A	N/A	6.9	0.0028	0.4	0.0327	0.06	0.0023
5.	.02 to .2	.0091	N/A	N/A	N/A	N/A	7.1	0.0029	0.5	0.0349	0.07	0.0024
6.	.02 to .2	.0091	N/A	N/A	N/A	N/A	N/A	0.0048	0.5	0.0339	> 0.2	0.0039
7a.	.02 to .2	.0091	N/A	N/A	N/A	N/A	N/A	0.0049	0.5	0.0338	> 0.2	0.0041
7b.	> .6	> .0091	N/A	N/A	N/A	N/A	N/A	0.0033	N/A	0.0369	N/A	0.0022
8	> .5	> .0091										

- Notes: (1) Gradient shown is the highest predicted by seepage model and may contain both x and y gradient components.  
 (2) Abbreviations: gpm/ft = gallons per minute per foot of embankment along axis alignment  
 (3) Flow into concrete defects reduced to simulate pressure build-up in foundation materials due to full piping defect completion

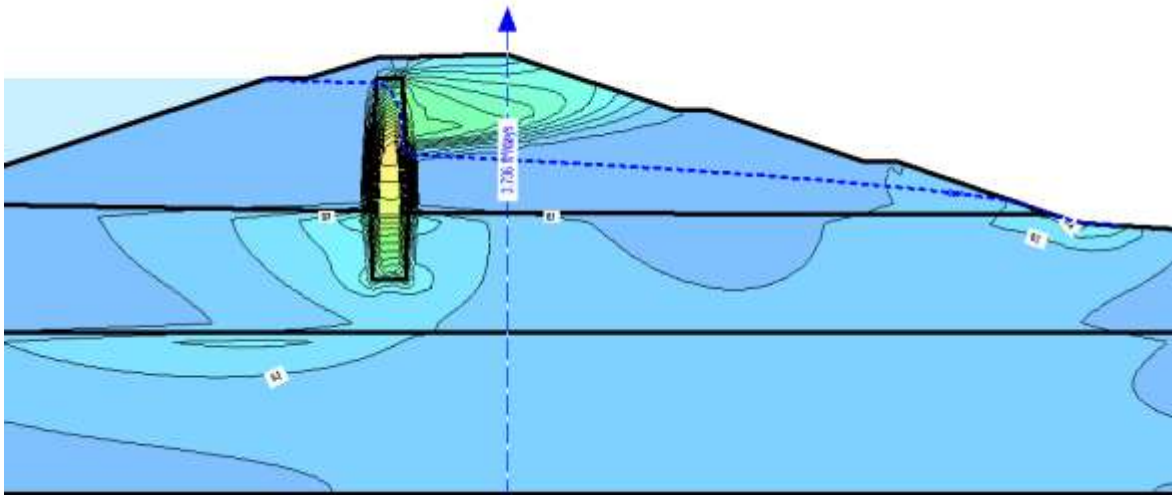

Figure 15. Seepage Gradients for Step 1, Base Case 1, Embankment Adjacent to Conduit

Figure 16 and 17 show estimated seepage gradients in the embankment and foundation along the model cross-section that includes the seepage conduit. Figure 16 shows gradients at the upstream end of the conduit at the end of Step 1, Base Case 1 without an open conduit defect, and Figure 17 shows the seepage gradients estimated at the end of model Step 2 when the defects at both the top and bottom of the conduit at the upstream defect are opened. As can be see by the gradients summarize at assessment point E in Table 3, the conduit defects have a significant influence on gradients and seepage conditions in both the embankment and foundation and are high enough to indicate initiation of erosion through the defects. In fact, considering 3-D effects, the model results summarized in Table 3 suggest that the exit gradients at the defects are sufficient to initiate and sustain embankment and foundation erosion at both the upstream and downstream defect locations.

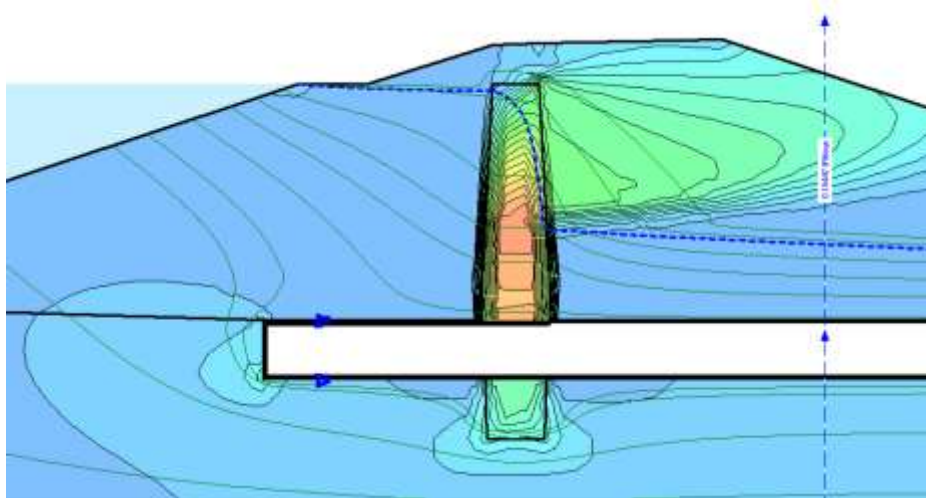

Figure 16. Seepage Gradients, Step 1, Base Case 1, Conditions along Conduit Cross Section

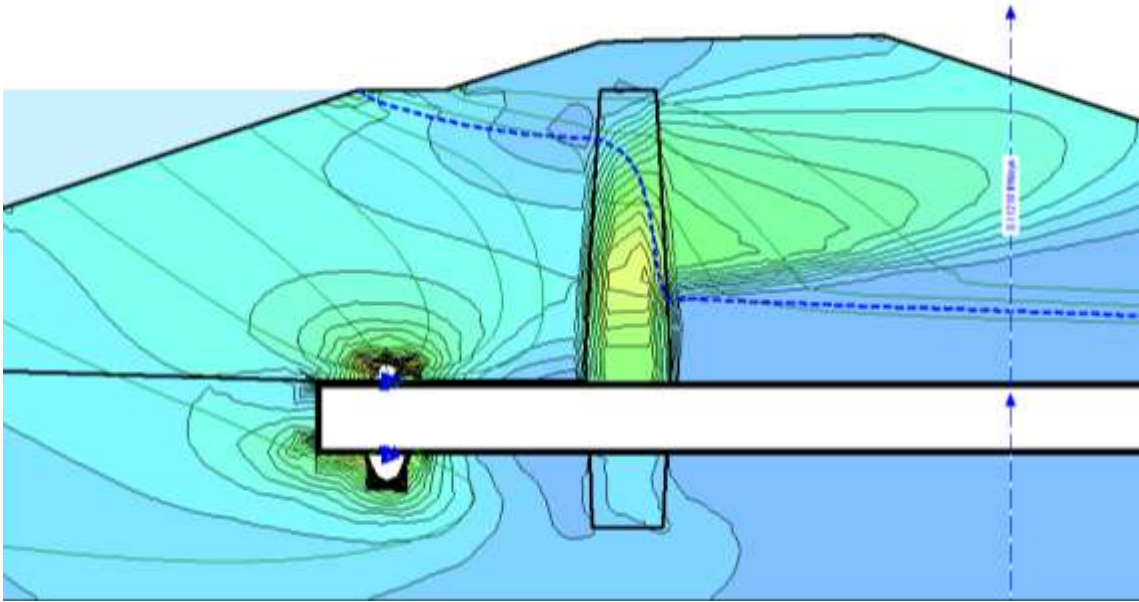

Figure 17. Seepage Gradients, Step 2, Base Case 1, Conditions along Conduit Cross Section

Seepage gradients in the upstream portion of the embankment and foundation, and near the downstream conduit defect at the end of Step 4b are shown on Figure 18. These results indicate that once a “piping” defect extending from the conduit defect into the embankment is introduced into the model during Steps 3, 4a, and 4b, gradients at the opening of the conduit defects drop into a cautionary range. However, exit gradients in the embankment adjacent to the upstream conduit defects as well as the into active front (upstream end) of the “piping” defects in the embankment remain very high (substantially above 1) and indicate that the erosion process would continue and accelerate as the defect approaches the upstream face of the dam. The seepage exit gradients from the embankment into the area adjacent to the conduit defects further suggest that other erosion pathways could develop even if a primary “piping” pathway has continued a portion of the distance toward the upstream face of the dam. As expected, the seepage quantities predicted by the model are substantially lower (0.03 gpm at the upstream defect, and 0.002 gpm/foot at the downstream defect) than observed discharging from the defects (up to 5 to 6 gpm at each location) during later inspections. While the model results do not indicate sufficient seepage quantities, the observed conditions at the defects described in the preceding sections indicate ample flow to sustain a steady continuation of erosion through the developing erosion features.

Seepage gradient contours, and equipotential lines within the model containing the outlet conduit at the end of Step 7 are shown on Figures 19 and 20. Estimated seepage gradients and flow quantities at each of the assessment points are presented for Steps 7 in Table 3.

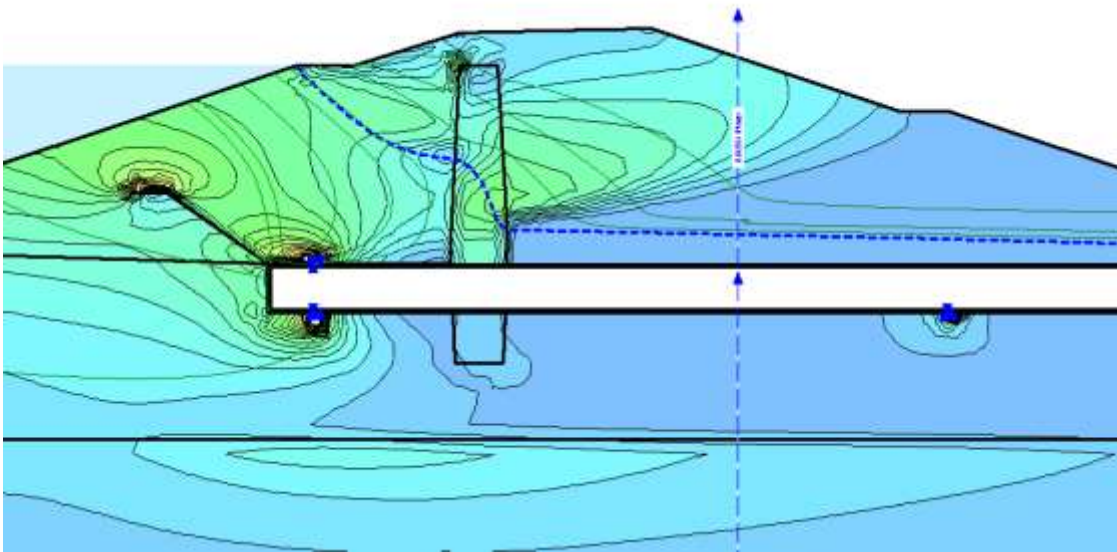

Figure 18. Seepage Gradients, Step 4b, Base Case 1 Conditions along Outlet Conduit Cross Section

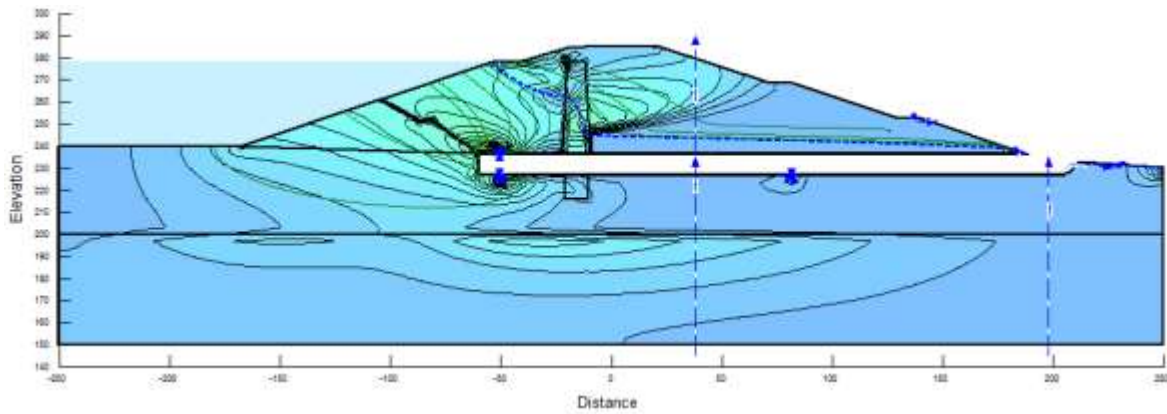

Figure 19. Gradient Contours at end of Step 7, Base Case 1

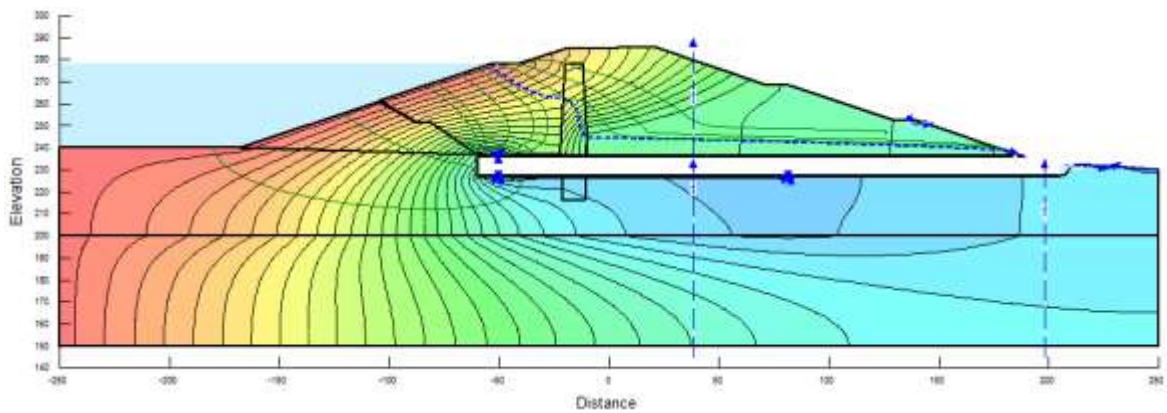

Figure 20. Equipotential Lines at end of Step 7, Base Case 1

As previously noted, the design details and construction of seepage control features including the minimal toe drain and the 1999 seepage remediation around the outlet conduit likely incorporated filter fabric and construction techniques that had a very high potential for clogging. Testimony further supports this hypothesis indicating that the 1999 remediation around the outlet conduit ceased to discharge after only a short period of operation, even with the indication of foundation seepage encountered during excavation for the remediation work. To gain some insight into the potential impact of clogging of the 1999 seepage remediation work at the end of Step 8, the Step 1, Base Case 1 model of the embankment adjacent to the outlet conduit cross section was modified to include a “clogged” remediation treatment. “Clogging” was simulated by decreasing the permeability of the treatment wedge at the downstream toe by two orders of magnitude. An overview of the phreatic surface and seepage gradients in the embankment and foundation is shown on Figure 21. A close up of the seepage gradients at and below the downstream toe of the dam is shown on Figure 22. Comparing the phreatic surface shown on Figure 21 with the surface shown on Figure 15 suggests that one of the results of clogging would have been to raise the phreatic surface and create the potential for breakout of embankment seepage on the lower bench of the embankment. Whether or not this actually occurred is not clear in the available information. In addition, the likelihood of this happening would have been reduced due to 3-dimensional seepage effects as the width of this treatment was limited (actual lateral limits of treatment are not known from the available information).

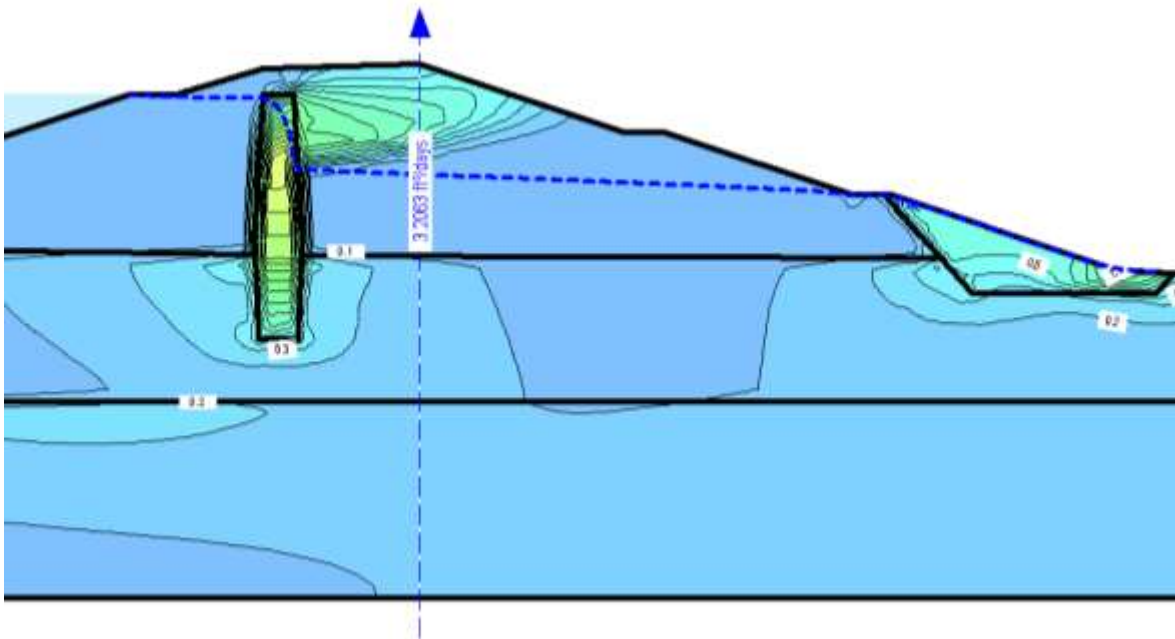

Figure 21. Effect of Clogging of 1999 Seepage Remediation Discharge End of Outlet Conduit on Phreatic Surface and Seepage Exit Gradients

However, the effect of this treatment on seepage flow patterns, and discharge gradients at the downstream toe could have been much more significant as indicated by the results shown on Figure 21. While we fully appreciate the limitations of the 2-dimensional seepage model to adequately represent the effect of clogging, the results shown on this figure would certainly suggest that the effect of the clogging of this remediation feature ,

particularly when combined with the effects of other piping defects simulated with earlier modeling steps described above, could have substantially increased the seepage exit gradients and flow quantities at the lateral and downstream margins of the feature. Further, any defect in the toe drain or in the foundation at this margin could have been easily exploited leading to the final stages of failure mode development similar to what has been described by both the Engineer and Maintenance Man during depositions. Hence, we have indicated that the exit gradients at the downstream toe of the dam (assessment point A), at this point in the failure mode development process would have been greater than (perhaps significantly greater) than the initial (Step 1) values as noted in Table 3.

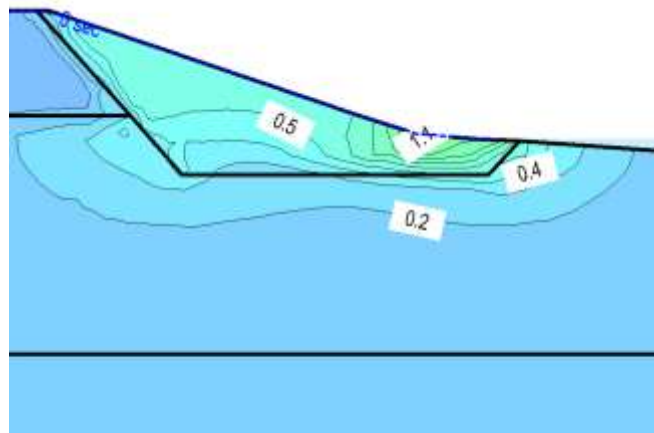

Figure 22. Close-up of Estimated Seepage Gradients Near Downstream Toe Resulting from Clogging of Seepage Remediation Feature

### CONCLUSIONS

This paper provides an initial overview and evaluation of the 2004 failure of Big Bay Dam. A potential failure modes framework has been used to identify the potential root cause of the failure, and to describe the steps of the failure mode process. A series of seepage models were developed to represent the steps of the failure mode process and inform this evaluation.

A combination of the design and construction characteristics, observed distress indicators, and seepage modeling results provide a basis to postulate that the root cause of the failure was a combination of the following three factors in relative order of importance:

1. A combination of design and construction deficiencies associated with the cutoff wall and seepage control features (both original and subsequent remediation work) lead to clogging/blockage of the seepage control features and eventual breakout of seepage at an unfiltered location below the toe of the dam,
2. Erosion and piping through defects in the outlet conduit likely caused the failure mode to begin under and through the upstream portion of the dam and foundation shortly after first filling. A continuous foundation seepage defect (pipe or series of pipes) eventually developed over time from the upstream face of the dam to a location near the downstream toe. This open foundation defect likely developed



through several cycles of initiation and continuation and may have existed as far downstream as the toe drain prior immediately prior to the final step of the failure mode development process. Such a feature provided the mechanism that caused the dramatic final stages of the failure described by both the Maintenance Man and the Engineer.

3. A rapid progression and breach formation followed a final cycle of erosion between the seepage breakout point just downstream of the toe of the dam and the continuous foundation erosion defect(s) that had fully developed around and under the outlet conduit.

Further reflection on the results of this assessment are challenging for the most enlightened of risk assessment experts. Specifically, it is interesting to deliberate whether or not a risk assessment could have adequately identified and considered all the factors that contributed to this failure if a quantitative risk assessment had been completed sometime prior to the 2004 failure event. Irrespective of this consideration however, it is the author's opinion that an experience dam safety engineer, given access to the site, and in full consideration of the design details and distress indicators that developed prior to the failure, would have taken action that could have prevented failure of this dam. Our assessment also strongly suggests that construction of a full and effective cutoff, a conduit without defects, and/or an effective internal embankment and foundation drainage system under the downstream shell of the dam would have significantly improved the safety of the dam and prevented its failure.

#### **ACKNOWLEDGEMENTS**

The author's would like to thank Mr. Dusty Myers, P.E. of the Dam Safety Division of the Mississippi Department of Environmental Quality and Mr. Mark Baker, head for dam safety for the National Park Service and leader of the ASDSO Dam Failure Investigation Committee for providing project information and supporting the evaluation summarized in this paper.

## REFERENCES

1. ASDSO Dam Failure Investigation Committee, Draft Dam Failure Investigation Guideline, December 8, 2011.
2. Eustis Engineering Company, Inc., Report on the Inspection of Big Bay Lake Dam, prepared for Ungar & Byrne, July 7, 2006.
3. Federal Emergency Management Agency (FEMA), Technical Manual: Conduits through Embankment Dams, FEMA 484CD, September, 2005.
4. Fell, R., Wan, C. F., Cyganiewicz, J., and M Foster, Time for Development of Internal Erosion and Piping in Embankment Dams, Journal of Geotechnical and Geoenvironmental Engineering, ASCE, April 2003, pp 307- 314.
5. Ferguson, K.A., Investigation and Evaluation of Seepage Conditions and Potential Failure Modes Around Outlet Conduits, Proceedings of the 2012 Annual Conference, United States Society on Dams (USSD), New Orleans, LA, April.
6. Ferguson, K.A., Soudkhah, M., and E. Sossenkina, Potential for Cracking around Outlet Conduits and Its Impact on Seepage Safety, Proceedings of the 2013 Annual Conference, United States Society on Dams (USSD), Phoenix, AZ, February, 2013.
7. Halpin, E., and K. Ferguson, US Army Corps of Engineers Dam Safety Program Status and Lessons in Transitioning to Risk Informed Approaches, ASDSO Journal of Dam Safety, Vol 2, Spring 2007, pp 24-36 .
8. Transcript of the Testimony of Timothy R. Burge, P.A., Taken December 18, 2007, Patricia Bradford, et al v. Land Partners, et al, prepared by Professional Shorthand Reporters, Inc.
9. Transcript of the Testimony of Jimmy Rae Daughdrill, Taken October 3, 2006, Patricia Bradford, et al v. Land Partners, et al, prepared by Professional Shorthand Reporters, Inc.
10. U.S. Army Corps of Engineers (Corps), ER 1110-2-1156, Safety of Dams – Policy and Procedures, October 28, 2011.
11. U.S. Bureau of Reclamation, Dam Safety Risk Analysis Best Practices Training Manual, Version 2, May, 2010.