

Accepted Manuscript

Building new kinds of meta-models to analyse experimentally (companion) modelling processes in the field of natural resource management

Bruno Bonté, Stefano Farolfi, Nils Ferrand, Géraldine Abrami, Mamadou Ciss Diallo, Dimitri Dubois, Anne Johannet, Wanda Aquae Gaudi

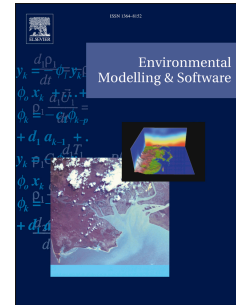

PII: S1364-8152(17)30843-5

DOI: <https://doi.org/10.1016/j.envsoft.2019.07.011>

Reference: ENSO 4486

To appear in: *Environmental Modelling and Software*

Received Date: 2 August 2017

Revised Date: 22 April 2019

Accepted Date: 18 July 2019

Please cite this article as: Bonté, B., Farolfi, S., Ferrand, N., Abrami, Gé., Diallo, M.C., Dubois, D., Johannet, A., Gaudi, W.A., Building new kinds of meta-models to analyse experimentally (companion) modelling processes in the field of natural resource management, *Environmental Modelling and Software* (2019), doi: <https://doi.org/10.1016/j.envsoft.2019.07.011>.

This is a PDF file of an unedited manuscript that has been accepted for publication. As a service to our customers we are providing this early version of the manuscript. The manuscript will undergo copyediting, typesetting, and review of the resulting proof before it is published in its final form. Please note that during the production process errors may be discovered which could affect the content, and all legal disclaimers that apply to the journal pertain.

Building new kinds of meta-models to analyse experimentally (companion) modelling processes in the field of natural resource management

Bruno Bonté^{a,*}, Stefano Farolfi^{b,*}, Nils Ferrand^a, Géraldine Abrami^a,
Mamadou Ciss Diallo^a, Dimitri Dubois^d, Anne Johannet^c, Wanda Aquae
Gaudi^a

^a*Irstea - UMR G-EAU*

^b*Cirad - UMR G-EAU*

^c*LGEI*

^d*CEE-M*

Abstract

In order to better manage complex situations of natural resource management, models are built in a participative way, involving the stakeholders of these situations in participatory modeling activities. The impact that this activity of participatory modeling has on the stakeholders is at the heart of the Companion Modeling approach but this impact is hardly possible to evaluate on the field. In this paper we propose a general framework to study *in vitro* the impact of participatory modelling on natural resources management. We illustrate our framework by proposing an experimental setting that looks at participatory modelling in the context of water management. We realized a pilot experiment and show that this experimental setting can be used to test, in the laboratory, the hypothesis that participatory modelling of a common pool resource situation has an impact on the way the resource is managed and increases the cooperative behavior of stakeholders.

*Corresponding authors

Postal address: UMR G-EAU, 361 rue J.F. Breton, BP 5095, 34196 Montpellier Cedex 5, FRANCE

phone: +33 (0)4 67 04 63 00

fax: +33 (0)4 67 16 64 40

Email addresses: bruno.bonte@irstea.fr (Bruno Bonté),
stefano.farolfi@cirad.fr (Stefano Farolfi)

Keywords: Companion Modelling, experimental economics, agent-based modelling, role-playing game, Integrated Water Resource Management

1. Introduction

The first version of the charter of the Companion Modelling (ComMod) approach was published more than a decade ago (Barreteau, 2003b). It was then signed by numerous researchers from various disciplines related to Natural Resource Management (NRM). The approach was adopted and developed in several case studies, with various stakeholders, and was used to tackle different problems (Étienne, 2011). Companion Modelling is, at the same time, both an approach and an epistemic and deontological stance that a modeller may adopt when involving stakeholders in the production of a model that represents a NRM situation in which they are taking part. It stems from the fact that involving the stakeholders of NRM situations, when modelling the situation in which they find themselves, may have an impact on that situation. For instance, if we bring fishermen into a room and ask them to explain their practices in order to build a model of fishery in the region, it may have an impact on the way fishery will evolve in that region. Consequently, from a rigorous scientific and civic perspective, this impact must be considered when models of NRM situations are built. Two main cases can be distinguished, depending on whether the objective of the model-building is to study the NRM system for scientific purposes only, or to explicitly use the modelling activity to improve a collective decision-making process. In the latter case, the model is used as a medium by stakeholders to specify their points of view and issues. The modelling activity is considered as the building-up of a shared representation of the environment. This shared representation (the model) can then be used to design concerted action plans.

It is difficult to assess the impact of modelling activity in natural resource situations in a falsifiable way *sensu* Popper (1959). Several proposals have been made for providing monitoring and evaluation protocols, with a view to making comparisons and improving the design of participatory modelling devices and the implementation of ComMod approaches. Such protocols are often used and useful (Jones et al., 2009; Perez et al., 2011; Hassenforder et al., 2016), and have been adopted in various cases. However, these evaluations focused on diagnosis (assessing for action) and were not dedicated to explaining how the modelling activity impacted the situation. In this paper,

we propose an original approach to address this issue. The aim was to design reproducible experiments, so that the results of the experiments could be refuted or replicated by our peers.

We identified two main challenges. The first challenge was that designing such an experimental setting meant handling concepts and objects used at various levels of abstraction (the concepts from the modelling language used to build the model, the model used during the ComMod process, the model that we used in the experiment to represent the model used during the ComMod process, etc.). We thus needed a robust conceptual framework, in order to specify rigorously the hypotheses we wanted to test and see how they could be refuted or confirmed. In order to take up this first challenge, we used a generic framework for meta-modelling called the Minsky triad conceptual framework (Bonté et al., 2012), which was developed to perform reflexive studies on modelling and simulation activities in general. The second challenge was related to the fact that the outcomes of companion modelling approaches may be very difficult to measure, being both context- and time-dependent. In order to take up this second challenge, we relied on experimental economics (Falk and Heckman, 2009) which addressed the issues of reproducibility, context dependency, etc.

Here, we transpose the conditions of a ComMod process into the laboratory by using the Minsky triad conceptual framework and the principles of experimental economics. To this end, we developed a software device based on the NetLogo platform and on the generic watershed modelling kit Wat-A-Game (WAG). This device, which we called AnaWAG for "Analyse Wat-A-Game" is available on the ComSES platform. WAG is a "paper and pebbles" participatory modelling kit that has been used in various water management situations in many countries for more than ten years (Abrami et al., 2012). Taking advantage of the experience accumulated with WAG, we designed the AnaWAG device to be easily adapted to other similar research.

In order to test and illustrate the relevance of our approach, we chose a specific case study in the field of integrated water resource management. This case study was a specific project undertaken between 2005 and 2008 in the Kat river valley in South Africa (Farolfi et al., 2010). The project implemented a ComMod approach, for better management of water resources in a sub-catchment. Hereafter following, we refer to it as the *Kat river ComMod process*.

In the next section, we introduce the rationale of our approach. In the third section, we extensively describe our framework and illustrate it with

our case study. In the fourth and fifth sections, we provide details of the implementation and results of a pilot experiment. In the last section, we discuss the limits and perspectives of the approach.

2. Rationale

2.1. Experimentation in the social sciences

Experimentation is a growing practice in many social sciences. Several disciplines, from psychology (Boring, 1950) to sociology and more recently from social psychology (Moreno, 1954) to political science (Druckman et al., 2011), have introduced controlled experimentation in the laboratory to test hypotheses about the observed behaviour of human agents. Experimental methods in economics became popular around the end of the 20th century. According to Levitt and List (2007), economists have increasingly turned to the experimental modelling of the physical sciences as a way of understanding human behaviour. Peer reviewed articles using the methodology of experimental economics were almost non-existent up to the mid-1960s. They exceeded 50 per year for the first time in 1982, and by 1998 the number of experimental economics papers published per year topped 200 (Holt, 2006).

In experimental economics, laboratory experiments enable the investigator to influence economic variables in a fully controlled environment, and thus measure the impact of those changes on the agent's behaviour (Falk and Heckman, 2009). In other words, the causal effects of economic factors are observed *ceteris paribus*. This type of observation is almost impossible to obtain outside a laboratory environment.

In economics, experimentation is characterized by a lack of protocol context and the neutrality of the experimental framework, which ensures that subjects do not reach an interpretation outside the scope of the tested hypothesis and give the greatest control to the experimenter (Czap et al., 2012). That said, several authors have pleaded recently for the introduction of elements of context in experiments, as a way of improving the external validity of observations, namely to improve the fact that generic results observed in the laboratory are also observed in the real world (Laury and Taylor, 2008; Anderies et al., 2013; Farolfi et al., 2014). According to Michel-Guillou and Moser (2006), contextualizing may also enable subjects to make context awareness explicit within their behaviour. Hence, some tests have been performed to assess experimentally how players behave during games about natural resource management (Desolé, 2011). These are preliminary results,

but it is now admitted that contextualized economic experiments, which take part of the system complexity into account, are important if we aim to understand stakeholder behaviour better, including issues of water resource management (Janssen et al., 2011a).

2.2. The Minsky triad conceptual framework

Marvin Minsky's definition of the term *model* is both precise and generic. It states as follows: *To an observer B, an object A* is a model of an object A to the extent that B can use A* to answer questions that interest him about A* (Minsky, 1965). Starting from that definition, Bonté et al. (2012) proposed calling the three entities *A*, *B* and *A** the "Minsky triad" (called *T*). The relation between the observer and the object is called ρ_o and the relation between the observer and the model is called ρ_m . The key idea of the framework was to build a model of the whole Minsky triad itself, in order to address questions related to the use of models in a given context. Therefore, in order to study the interactions between the three entities of the triad, the proposal made in (Bonté et al., 2012) was to build a model *T** of the triad *T*.

The Minsky triad conceptual framework was originally created to evaluate models of any systems that are ill-defined, incompletely known and which, for whatever reason, cannot be tested under real conditions, such as economic systems on a country scale, epidemics, or natural disasters, for instance, where human lives are the main issue. In this paper, we explain how this framework can be used to study ComMod processes.

ComMod processes are characterized by a succession of models built iteratively. Each loop of model building is associated with a collective learning process. In the *Kat river ComMod process*, three different versions of a model representing the Kat river sub-catchment were built (two agent-based models and one role-playing game model) (Farolfi et al., 2010). We focused in this study on the first modelling loop during which the first model called *KatAware* was built. We refer to it hereafter as the *KatAware triad* that we called *T*. In the *KatAware triad T*, the object *A* was the whole Kat river sub-catchment, the observer *B* was a group composed by the members of a recently created water users' association at the level of the Kat river. The question that the group of stakeholders *B* had about the Kat river sub-catchment was as follows: "How can a catchment action plan in the Kat river Valley be collectively designed?" and more precisely: "How should water use licences be attributed to water users and at what price?". In order to answer

to these questions, the group, B , built the first version of the agent-based KatAware model, which we called A_B^* .

The general question that we had about this ComMod process was as follows: "Does participatory modelling foster cooperation in the real situation?" In order to answer that question, we followed our method to build the corresponding experimental design.

Considering our case study, the exercise could be summed up as follows. We, as researchers in experimental social science had a question about the KatAware triad T and, in order to answer that question, we built and used a model of the KatAware triad (which we called T^*), itself comprising three entities. The first entity was a model of the situation in the KatRiver. The second entity was a model of the group of stakeholders. The third entity was a model of the KatAware multi-agent model built and used in the Kat river ComMod process. We chose or built these models according to the question we had about T .

In the next section, we propose a general framework for building models of ComMod processes based on experimental economics. We illustrate our framework by the presentation of our model of *the Kat river ComMod process*.

3. Proposal: The ExpeComMod triad

Our general framework was called the ExpeComMod triad. It is summarised in Figure 1, which can be read as follows: in order to address research questions about the use of a model (box A_B^*) within a ComMod process considered as the ComMod triad (box T), researchers in experimental social science (circle C) build a model of the ComMod triad (box T^*). In this context, the relationship that the researchers in experimental social science have with the ComMod triad is that they have research questions about it (arrow ρ_{o_c}). From these research questions, they can formulate hypotheses and design experimental plans that they will perform with the Model of the ComMod triad (arrow ρ_{m_c}). The question of the observer C does not concern the model A_B^* itself, but the use of the model A_B^* by the observer B . Consequently, the model of the ComMod triad (box T^*) contains a model of each entity and relation present in the ComMod triad (T). We designated as the "abstract NRM situation" (box A_C^*) the model used by researchers in experimental social science to represent the NRM situation (A). We designated as the "meta model", the model of box A^{**} used by researchers in experimental social science to represent the ComMod model

A_B^* . We designated as the "group of subjects" the group of people in position B^* on which experiments were performed and which are a model of the group of stakeholders B .

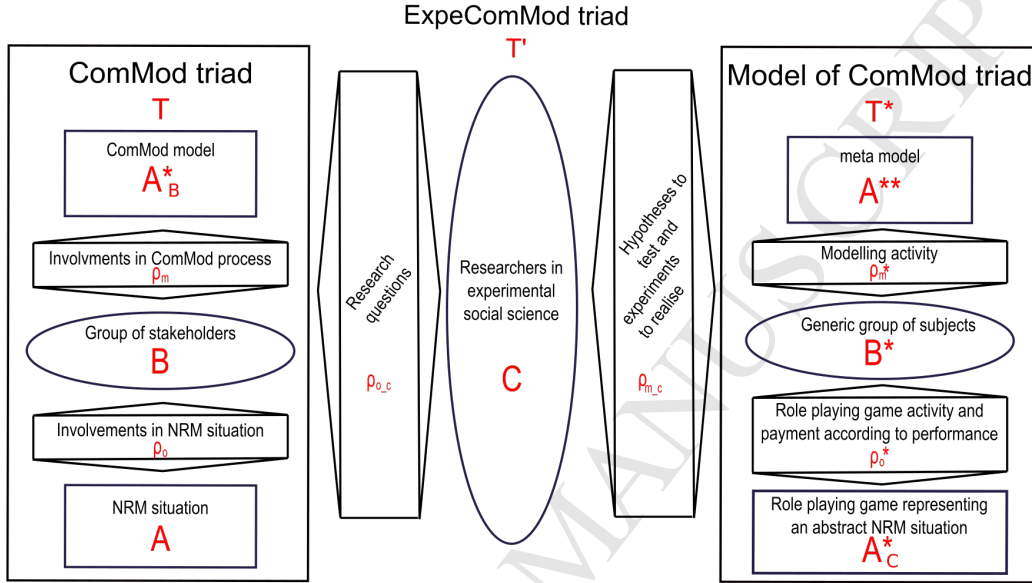

Figure 1: The Minsky triad general framework T' (adapted from (Bonté et al., 2012)).

The ExpeComMod triad (called T') is created in the process. The observed object is the ComMod triad (T), the observer is the group of researchers in experimental social science (C) and the model is the model of ComMod triad (T^*). We present these three entities in detail in this section.

3.1. The ComMod triad

A great deal of literature is available on ComMod processes (see a summary in Étienne (2011) for instance) and we refer to it for further details. The synthetic vision that we propose here merely seeks to explain how we see such a process under the lens of the Minsky triad framework.

3.1.1. The NRM situation

At one moment of the process, the NRM situation (A) is specified by a scope defined (more or less strictly) by either a research project, or a local development project, or a combination of both.

In our case study, the Kat river ComMod process, the NRM situation was scoped by the research-action project called "a stakeholder driven process to

develop a catchment management plan for the kat", founded by the South African Water Research Commission. The project established the area as the Kat river quaternary sub-catchment of 1700 km² including 19 km² of irrigated area and home to around 50'000 inhabitants in 2001. Irrigation took up by far the majority of the water in the catchment and relied mostly on the Kat Dam situated in the upstream section of the catchment, with a 24.10³m³ storage capacity (Farolfi and Rowntree, 2006). Figure 2 presents the Kat river catchment and the main Kat river water users.

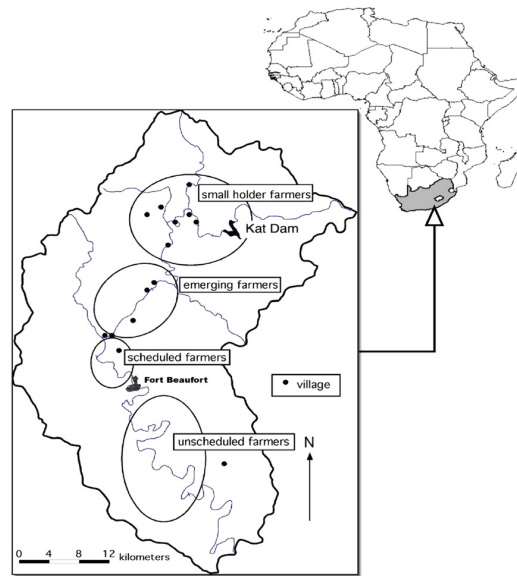

Figure 2: The Kat River Catchment (from (Farolfi and Rowntree, 2006)).

3.1.2. The group of stakeholders

The group of stakeholders (B) is a heterogeneous group in which we distinguished four main types: 1) Stakeholders of the NRM situation, who has been identified by the ComMod process for various reasons (we will discuss these reasons when we describe their relations with the NRM situation); 2) Experts who has no stake in the situation but has expertise in the objects involved in the NRM situation; 3) Researchers or facilitators who lead the ComMod process; 4) Possibly, the funding organizations of the process, which may be external to the process (research funding agencies, local or national state departments, international development agencies, etc.).

Considering the heterogeneity of the group of stakeholders B , we had to acknowledge that they may have different kinds of relations with the NRM situation, which we called their 'involvement' in the NRM situation (ρ_o relation). We assumed three non-exclusive possibilities for each individual in the group: 1) knowledge (the individual has information about the NRM situations); 2) stake (the individual has a stake in the NRM situation); and 3) power of action (the individual, as a decision maker, can change the NRM situation through their decisions).

In the Kat river ComMod process, the group of stakeholders was composed of the researchers involved in the research-action project (including hydrologists, economists, social scientists, computer scientists, etc.) and the members of the Kat river Water Users' Association composed of representatives of different categories of farmers in the area and representatives of domestic water users from different parts of the area. In this study, we focused on the group of farmers. All farmers had some stakes, knowledge and power of action at their levels of the catchment.

3.1.3. *The ComMod model*

Even though the ComMod community is not restricted to a specific kind of model, the ComMod models A_B^* , used and built during ComMod processes usually share some common characteristics and acknowledge commonly used paradigms. Indeed, since NRM situations involve and are usually determined by the decisions of stakeholders regarding the situation, it is interesting for the A_B^* models to explicitly represent the beliefs, goals and decision processes of these stakeholders. For this reason, the most commonly used paradigm is the Multi-Agent-System paradigm in which the world is represented as a set of objects situated in an environment and manipulated by autonomous agents, who represent social entities and can modify the object of the environment, move, communicate, etc. This paradigm can easily be mapped either to computer Agent-Based-Models (ABM) or to Role Playing Games (RPG). When RPG models are used, stakeholders are invited to play their own roles in order to represent and discuss scenarios that can happen in their NRM situation (Barreteau, 2003a).

The version 1 of the KatAware model, which we focused on in this study, is an ABM. It is extensively described in (Farolfi et al., 2010).

3.1.4. *Involvement of the group of stakeholders in the ComMod process*

Depending on a) the kind of model used, b) the question addressed by the ComMod process, and c) the nature of the group of stakeholders, the involvement in the ComMod process of the group of stakeholders (relation ρ_m) can have several dimensions. For this relation, we assumed four non-exclusive possibilities of action and four non-exclusive possibilities of intention. The actions may be either:

- facilitating the modelling and simulation activity and providing the modelling language (the individuals, usually the facilitators, provide a language to build the model and facilitate the process);
- building the model (the individuals take part in the modelling process)
- simulating the model by role-playing (the individuals take part in a participatory simulation of an RPG model, where they are invited to play a role);
- simulating the model by changing parameters and observing simulation results.

The intentions may be either to:

- learn about the system (the individuals want to understand how the NRM situation works)
- learn about the strategies of stakeholders or decision-makers (the individuals want to understand strategies of specific stakeholders or decision-makers)
- use the model to convey a message (the individuals want to use the model simulation or model building process to influence other members explicitly or implicitly)
- or hide a strategic behaviour (the individuals participate in the process for some specific reason, but do not want to expose their strategy).

In the Kat river ComMod process, considering the group of farmers and the building of version 1 of the KatAware Model, which was an ABM, we considered that these farmers had participated in building the model (see

Figure 3 left) and in simulating the model by changing parameters and observing simulation results (see Figure 3 right). We did not measure the intentions that these stakeholders had when participating in the Kat river ComMod processes. Considering farmers, we could assume that all the intentions listed above were potentially present.



Figure 3: On the left: Groups discussing water demand over an year during the first Companion Modelling workshop with the Kat River Water User Association (picture by B. Bonté from (Farolfi and Rowntree, 2006)). On the right: group of stakeholders of the kat river WUA choosing parameters and observing simulation results with a facilitator.

3.1.5. Question addressed by the ComMod model

The last remaining element of the ComMod triad is the question addressed by the group of stakeholders. Although the group of stakeholders is heterogeneous and has a complex involvement in both the NRM situation and the ComMod process, and even though the question addressed by the ComMod process is dynamic (it may change during the process), the question is usually precisely expressed at any moment of the process, since it is part of the contract established between all the participants in the ComMod process.

In the Kat river ComMod process, as mentioned above, the question was to design a new catchment action. For the farmers of the WUA, one of the main issues was access to water rights that might enable the use of water from the Kat Dam, which at the time was only available for scheduled farmers (see Figure 2).

3.2. A question about the ComMod triad

The objective of our approach was to use models, *sensu* Minsky, to reflect upon ComMod processes. We may wish to raise numerous questions about ComMod triads, but we have very little visibility in terms of defining the limitations of the type of question that can be addressed using models based

on social experimentation. Computer models have been built and used to address questions about some aspects of the ComMod triad. For instance, an agent-based model was designed by Emmanuel Dubois to assess how player attitudes can change during a role-playing game, depending on the game settings (Dubois et al., 2013). However, the impact of the participatory modelling activity has never been explicitly addressed by the use of a model. In our case study, we proposed to address a specific question about this.

In our case study, our question about the T^* ComMod triad described above was as follows: "*Does participatory modelling foster cooperation?*". To answer this question, we proposed the model of the ComMod triad described below. As in any modelling process, the question asked already scoped the system to be represented: we looked at the effect of "participatory modelling" activity and not at the effect of an entire ComMod process where participants inhabit the system they model, usually simulate or play with the model they build, etc.

3.3. A model of the ComMod triad

In order to build a model of the ComMod triad, we needed to identify an object or a set of objects and concepts that could be used to represent the ComMod triad. Moreover, we wanted to be able to perform reproducible controlled experiments on this object or set of objects, which we used as a model, and we wanted to be able to identify all the entities and relations presented previously as part of the ComMod triad.

3.3.1. Modeling the group of stakeholders

We propose to use theories and practices from experimental economics in order to use groups of people to represent the group of observers B of the ComMod triad. In accordance with Minsky triad framework, we designate this group B^* and we called it a "group of subjects". University students randomly chosen with specific methods are commonly used in experimental economics to represent a generic group of people (Falk and Heckman, 2009). Following the prescriptions of experimental economics, the subjects for the experiments are chosen among university students and are paid at the end of the game sessions according to their performance during the session Harrison and List (2004); Eber and Willinger (2005).

In our case study, we constituted groups of four people from the pool of subjects at the Laboratory of Experimental Economics in Montpellier (LEEM).

3.3.2. Modeling the NRM situation

The model of the NRM situation used in the model of the ComMod tirad may be very simplified (abstracted) compared to the NRM situation of the ComMod process. We propose to build it as a controlled role-playing game in which players are put in a similar situation to that of the stakeholders of the ComMod triad. Of course, the similarity of the situations has to be measured with regard to the research question about the ComMod triad: level of knowledge, stakes and power of decision that stakeholders has regarding the NRM situation.

In our case study, we wanted to take into account the fact that the NRM situation of the ComMod triad was about water management and agriculture, and that there was an asymmetry of access to the resource and to the associated infrastructure. We also needed to represent the fact that the stakeholders had stakes in the situation and some power of action over it. Since our research question was very general, and the players of the game were mostly students who were not well aware of complex NRM situations, we tried to find the simplest RPG that could respect our constraints and in which we could measure whether the players cooperated or not. Hence, the model of the NRM situation that we considered was the textbook case of an irrigated scheme with several farmers dealing with the double problem of provision to a public infrastructure (contribution to the operating costs of a borehole, providing supplementary water to the scheme in the event of drought) and extraction from the common pool resource represented by the water available through the irrigation scheme. It referred to the case used by Janssen et al. (2011a,b) where the authors combined a public good game with an extraction of common pool resource (CPR) game, in which players must first decide how much to contribute to the CPR, and then how much to extract from it for their own payoff. In order to put the players in this situation, we used elements of the Wat-A-Game modelling tool kit widely used in ComMod processes involving water management (Abrami et al., 2012, 2016). Using this modelling language, modellers can use pebbles of various colours to represent resources (such as water or money), "land plot cards" to represent land plots owned by the players, "activity cards" to represent activities consuming and generating resources, and "river path cards" to represent canals. During each turn of the role-playing game built with these elements, a facilitator makes the water pebbles flow through a network composed of river path cards and land plot cards. When the pebbles reach a land plot on

which an activity card stands, the owner of the land plot cards can choose to extract water pebbles from the river in order to perform the activity and gather the resources generated by that activity. At the end of the turn, players can change the activity cards standing on the land plot cards they own. For this study, we computerised the Wat-A-Game as a network game coded in the NetLogo Agent Base Modelling and simulation platform so that we could control the information available to the players. Figure 4 presents our conceptual model of the NRM situation on the left, and the graphic interface of its implementation as a computerized Wat-A-Game RPG. The details and implementation of the WAG RPG are described in Section 4.

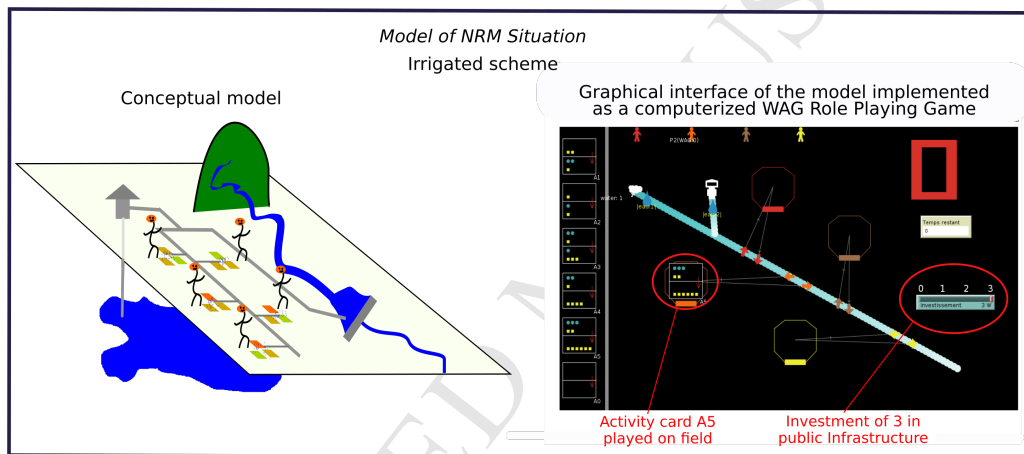

Figure 4: Model of the NRM Situation.

3.3.3. Modelling the involvement of the group of stakeholders in the ComMod process

The relation between the model of the NRM situation and the group of subjects may not be exactly the same as that between the group of stakeholders B and the original NRM situation A since we do not want to face the same issues as in the real ComMod triads, where experience is hardly reproducible. However, some aspects of the relation remain to be studied, such as knowledge about the situation, or even stakes in the situation. Most importantly, the group of subjects B^* must be able to build the meta model A^{**} as their own representation of the model of the NRM situation, built in order to answer a question they have about that situation. To do so, and in order to have reproducible controlled experiments, we need at least

a pre-defined modelling language limiting the noise that would occur if any kind of model was possible. Thus, the model of the ComMod triad must include a modelling language that the group of subjects can use to build the meta model A^{**} . Hence, the relation of the group of subjects to the meta model (ρ_m^* relation) must at least include the modelling activity. It may also include some of the intentions and actions that the original group of stakeholders B may have with the original model A_B^* (presented in the ComMod triad subsection, Section 3.1.4).

The group of subjects may also somehow have some power of action, stakes, information etc. in the model of the NRM situation in order to represent the relation of the stakeholder of the ComMod triad to the real NRM situation.

In our case study, the groups of subjects participated in a modeling activity with pens and post-its, during which the members of a given group did not have the same pieces of information and they were told to engage in a role and build a model of their situation as a drawing (See Figure 5). This first activity represented the relation that the stakeholders had with the model in the ComMod triad (ρ_m^*).

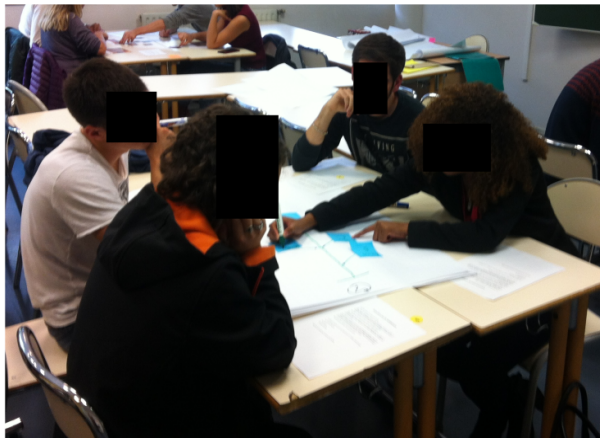

Figure 5: Groups of subject building a model of the NRM situation

The groups of subjects were then asked to play the computerized WAG RPG. Following the precepts of experimental economics, this phase took place in a laboratory of experimental economics under controlled conditions (See Figure 6). The players were paid according to their results in the game. In the pilot experiment, the participants earned from 7 euros to 60 euros for

a two-hour experiment. This second activity, where the players had power of action and stakes in our model of the NRM situation, represented the relation of the stakeholders to the NRM situation in the ComMod triad (ρ_o^*).

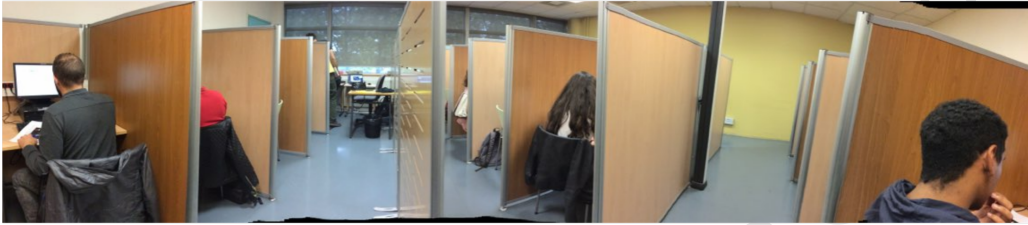

Figure 6: Groups of subject playing in experimental condition to the computerized RPG representing the NRM situation

3.3.4. Modelling the model

As is the case for the models (A_B^*) used by stakeholders of real ComMod triads, the models that we can use to represent them in models of the ComMod triad (the meta-model A^{**}) may have several forms, from conceptual models drawn on paper up to ABM.

In our case study, we used drawings used as conceptual models by the groups of subjects. Such a model can be seen in the table in the middle of the picture Figure 5.

3.4. The experiment and its analysis (ρ_{m_c})

Following the general framework of the Minsky triad, now that we had specified the T^* model, we needed to specify which experimental plan (which set of experiments) would be performed on this model.

In our case study, we wanted to test the following hypotheses H0 and H1:

- H0: If people take part in the participatory building of a model representing a situation in which they have a stake in shared resources, and in which they have power of action, they will change their behaviour once they are placed in this situation.
- H1: If people take part in the participatory building of a model representing a situation in which they have a stake in shared resources, and in which they have power of action, they will cooperate more once they are placed in this situation.

In order to test these hypotheses, and following the precepts of experimental economics, we propose to submit a population of students to two different treatments: T0 and T1.

In our case study, for each treatment, N groups of 4 players, called G_{ij} were composed. Where, $i \in \{T0, T1\}$ was the treatment number (see below) and $j \in [1; N]$ was the index of group j of a given treatment i . Groups submitted to T0 were asked to have some group activity unrelated to the NRM situation and then to play to the computerized role playing game (the model of the NRM situation). Groups submitted to T1 were asked to build the meta-model A^{**} and will then were asked to play the computerized RPG (the model of the NRM situation).

The level of cooperation of the groups of subjects was assessed in two dimensions, using their total contribution in the public infrastructure (the more they contributed, the more we considered that they cooperated) and their choice of activity as described in Section 4.1.

4. Details and implementation of the case study model of the Com-Mod triad

4.1. The computerized role-playing game

The AnaWAG device includes a client-server "network game" module (see Appendix D), such that the experimenter can stand behind a server computer and each player stands behind a separate computer with a client interface displaying only a chosen set of information and allowing only a chosen set of possible actions.

We calibrated the game in order to be able to measure the cooperation or non-cooperation of players and to limit the number of players and the duration of the game. As repetition is necessary in order to create the conditions in which players can learn, we considered a repeated game with 15 rounds per session

The irrigation scheme was fed by two sources of water:

- The surface water source, supposed to come from a reservoir regularly filled with rain. The amount of surface water was known by the players and always equal to 1 unit of water.
- The ground water source, whose delivery depended on the players' investment, representing their contribution to the public infrastructure (see Figure 7 and Section 4.1 below).

Name	water In	water Out	WAG In	WAG Out	signification
A1	0	2	2	1	High water production with negative profit
A2	0	1	1	1	Water production with no profit
A3	2	1	1	3	Moderate water consumption, moderate risk and moderate profit
A4	2	0	1	4	High water consumption, moderate risk and high profit
A5	3	0	2	6	Very high water consumption, high risk and very high profit

Table 1: Available activity cards in A_c^*

Each player possessed one plot of land, where he could place an activity card. Each activity needed resources (WAGs: the money, and clean water), produced WAGs and eventually rejected clean water reusable in the irrigated scheme. The activities available are presented in Table 1. An activity was entirely defined by the type and quantity of resources it needed and the type and quantity of resources it produced (for instance, activity A3 consumed 2 units of water and 1 WAG and produced 1 unit of water and 3 WAGs). In order to set up on a field, a player had to invest the monetary resource needed ("WAG in" in Table 1). If the water available was not sufficient (there were fewer than "Water in" units of water in the river at the level of the field), the investment was lost and no resource was produced. Otherwise, the player received the produced money ("WAG out") and the produced amount of water ("Water out") flowed back to the river.

At each turn of the game, all the players made two individual decisions. They chose:

- how much to invest in public infrastructure (the total investment of the group would determine the water available from the public infrastructure as shown in the Figure 7),
- the activity to put in their fields, which implied the water extraction level according to the figures presented in Table 1.

A report on the status of their own savings and on the quantity of the re-

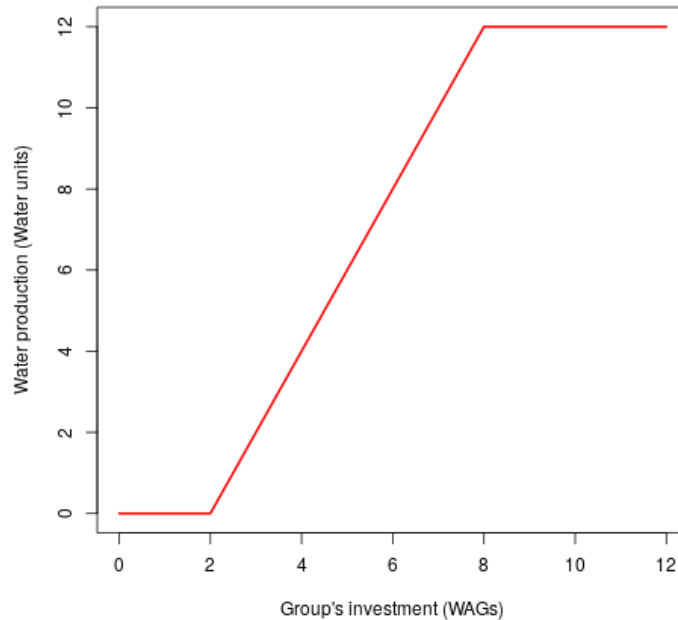

Figure 7: Water production function of the ground water infrastructure.

maining water downstream of the irrigated scheme was shown to players after each round.

Investment in public infrastructure: The production function for public infrastructure depended on the sum $y = \sum_{i=1}^4 y_i$, where y_i was the contribution of player i . In order to capture some aspects of the nature of irrigation systems - namely increasing returns to scale for lower levels of investment and decreasing returns for higher levels - we employed a linear production function presented in Figure 7.

Referring to (Anderies et al., 2013), and thinking about the Kat River Dam of our case study, we chose a scaling that produced a range making it impossible for one person to create a public infrastructure without the help of the others.

Investments in activities: After having made the water resource available, the second investment of players took the form of the activities they chose to set up on their lands. As described in Table 1, this choice was related to the profit that the card can provide and the risk they take of losing

their investments if there is not enough water. This decision involved two uncertainties: 1) the uncertainty of the investments that would be made in the public infrastructure, responsible for the amount of ground water supplied by the public infrastructure; 2) the uncertainty of the activities to be played by upstream players.

Final payoff of players: The payoff of a player i for each round r resulted from the payoff derived from the production of their activities minus the amount of WAG invested in the public infrastructure. The final payoff, given by Equation 1 was computed as the sum of the payoffs of all repetitions.

$$P_i = \sum_r^{[1;R]} [E - y_{i,r} + C_{i,r}^{OK} \cdot C_{i,r}^{OUT} - C_{i,r}^{IN}] \quad (1)$$

where,

- $r \in [1 : 15]$ is the index of the repetition,
- P_i is the total payoff of player i ,
- E is the initial number of WAGs given to each player at each repetition,
- $y_{i,r} \in [0; 3]$ is the number of WAGs invested in the public infrastructure by player i at repetition r ,
- $C_{i,r} \in \{A1, A2, \dots, A5\}$ is the activity card played by player i at repetition r ,
- C^{IN} is the number of WAGs needed for the installation of activity C ("WAG in" in Table 1),
- C^{OUT} is the number of WAGs produced when activity C was performed ("WAG out" in Table 1),
- $C^{OK} \in \{0, 1\}$ specifies whether the activity was performed (enough water in the river), or not (not enough water in the river). If a player did not get the water he needed through one of his activities, he was not paid for that activity and lost the WAG invested in that one.

Measuring cooperation: We had two indicators to measure player cooperation: the first was the total contribution to the public infrastructure (the more the players contributed, the more they cooperated), and the second

was the activity cards that players play (the more players played activity cards with low numbers, the more they cooperated). In order to qualitatively estimate whether groups had a cooperative or selfish behaviour, we compared their actions to economic equilibrium.

Cooperative players would coordinate in a stable and durable way to reach a cooperative equilibrium where all players would have the same payoff: players would all contribute the same amount (1 to 3 WAGs each) and would play all the same card (A3 if the group contribution is "4" or A5 if the group contribution is 8 to 12). The corresponding group payoffs would be: 4 if group contribution is 4 (all play A3); 8 if group contribution is 8 (all play A5); 4 if group contribution is 12 (all play A5). The optimal equilibrium is when all contribute 2 WAGs each and play A5. Then, they would reach a group payoff of 8 (highest group payoff corresponding to equal individual payoffs).

On the other hand, perfectly selfish and informed players would reach a Nash equilibrium, where player 1 (the only one that can take advantage of surface rainwater) would contribute 3 WAGs and play card A5, for a net payoff of 1. All other players, expecting that player 1, would contribute the minimum (1) necessary to play the card that would give them the highest possible payoff (A4) with the minimum effort. This would produce a group investment of 7 for a group payoff of 6.

Hence, we created a model of the NRM situation representing the Kat river case study in which we had individual stakes, a public infrastructure, asymmetric access to the resource and to the infrastructure and a benefit from cooperating. One of the issues of the cooperation was a management issue, since upstream players needed to understand that downstream players would be interested in contributing only if they derived some benefit from their contribution. Using a scenario of repetitions, we were able to test whether the groups of players performing participatory modelling cooperated, and therefore managed water in a way to move closer to the highest level of payoff for all, more easily than other groups.

4.2. The pilot experiment

Preliminary analyses were conducted over 300 observations, produced by an experimental pilot session undertaken over 15 repeated periods on 5 groups of 4 subjects each. Three groups were assigned to the 'Model treatment' (M) and two to the 'Puzzle treatment' (P). Instructions for the two treatments are available in the Appendix.

5. Results of the pilot experiment

A summary of the descriptive statistics concerning the main variables analyzed is included in Table 2.

Variable	Obs	Mean	Std. Dev.	Min	Max
groupe	300	3.00	1.42	1	5
player	300	2.50	1.12	1	4
profit	300	.670	2.12	-5	4
investment	300	1.44	.826	0	3
round	300	13.0	4.33	6	20
activitynum	294	4.26	.979	0	5
profitcumule	300	5.82	11.7	-20	50

Table 2: Summary of players payoffs in the pilot experiment.

5.1. Individual choices by treatment

The results show that there was no treatment effect in terms of individual contribution, which was close to 1.43 WAGs in both treatments (Wilcoxon Mann-Whitney test p-value = 0.936).

In terms of the choice of activity cards, and therefore the strategy of resource extraction, after conversion of the labels of cards (A0-A5) to numbers (0-5), the average card played by individuals was 4.34 for M and 4.12 for P. A treatment effect was detected (Wilcoxon Mann-Whitney test p-value = 0.015 on the categories and 0.0495 on the labels of the cards converted in numeric values).

The resulting average individual payoff per period was 0.72 WAG in the M treatment and 0.60 WAG in the P treatment. Running a Chi2 test on the distribution of average individual payoff per period, a treatment effect was shown, with a p-value = 0.013.

The distribution of the individual payoff per period showed that extreme values (positive and negative) were more frequent in the M treatment. Globally, individual payoffs of 1 to 3 amounted together to 60% of occurrences, and 1 was largely more frequent in the P treatment while 3 dominated in the M treatment.

Figure 8 shows the dynamics of the individual cumulated payoffs in the two treatments. The plot of the M treatment was consistently above that for the P, despite a decrease in the last 3 periods, and the average individual

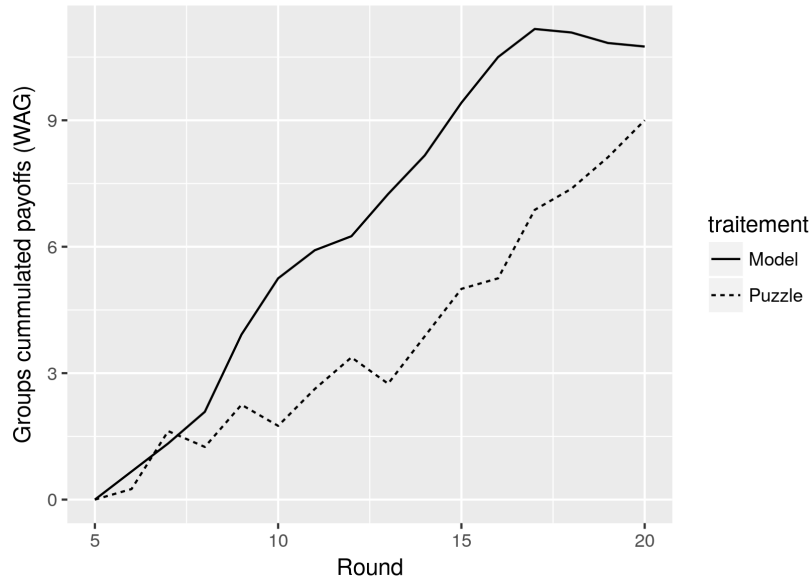

Figure 8: Cumulated groups payoffs observed in the pilot experiment.

cumulated payoff was 6.9 WAG in the M treatment and 4.09 in the P treatment. A t test p-value = 0.024 showed that there was a significant treatment effect over the whole session.

5.2. Comparison of results with expected equilibria

In the experiment, players in both treatments contributed an average amount per round of 1.43 WAG (close to 6 WAG/group), while the average card chosen was between A4 and A5 (4.34 in Model and 4.18 in Puzzle). These average choices were very close to a Nash equilibrium, but due to free-riding of upstream players, they led to much lower group payoffs than what would be expected in a Nash equilibrium: 2.8 WAG and 2.4 WAG respectively for the M and the P treatments instead of 6 if players had played the Nash equilibrium (as explained in Section 4.1).

This distance from equilibrium might be explained by the fact that players within each group had different behaviours depending on their position. Players upstream (1 and 2) played higher activity cards than players downstream (3 and 4). Players downstream conversely tended to invest more in the public infrastructure, certainly hoping that the upstream players would not free-ride on the common resource produced. This different behaviour

between players with asymmetric access to the resource in a group provoked gaps in terms of individual cumulated payoffs far from cooperative equilibrium. Figure 9 shows the average individual cumulated payoff per player (1 to 4) in the groups of treatment M and in the groups of treatment P. In the groups of treatment M, more extreme behaviour was observed, bringing higher payoff to player 1 and leaving player 4 with negative payoffs, while in the groups of treatment P, player 1 extracted less common resource, especially during the first ten periods. This allowed the three other players to finish the game with non-negative payoffs.

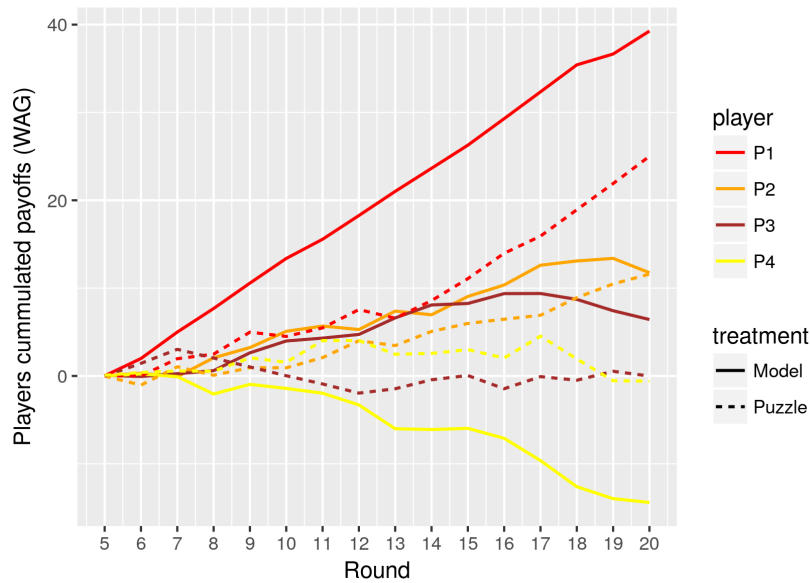

Figure 9: Cumulated players payoffs in the pilot experiment.

5.3. Learning and individual decision-making

In order to better understand the process of individual decision-making, a multi-level mixed effect linear regression analysis was run on the individual level data of investment (contribution to ground water extraction) and choice of activity card (corresponding to the water extraction level). The impact of three variables representing the information available to the subjects about their choices or their situation at the time of decision-making (t), or in the previous round ($t-1$), was estimated. The regression estimated the player's investment at time " t " according to the activity played at time " t ", the

round "t", the profit at time "t-1" and the value of the dummy variable "Not-played" at time "t-1", indicating whether or not the player received enough water to play his activity card at time "t-1". The regression was estimated separately for the two treatments (M and P).

Whatever the treatment, the decision to invest was significantly and negatively affected by the individual profit at t-1, as if a good level of payoff reached previously would push the subjects to reduce the level of contribution to the common resource (free-riding on the group), to have an even higher payoff in round t.

We observed a significant and negative impact on individual contributions of the "Not-Played" variable at t-1. Clearly, the occurrence of such an event (impossibility of playing a card in the previous round) pushed the players to reduce their investments at time t. As we observed in the data that this occurrence was more frequent for downstream players, we considered that such a behaviour corresponded to the 'social sanction' that downstream players could impose on upstream players, seen as "Stationary bandits" (Janssen et al., 2011b).

Playing a higher activity card in round t had a positive impact on the player's investment at the same period in the M treatment, but it was not significant in the P treatment.

And lastly, there only seemed to be a learning effect (negative and significant correlation with the variable 'round') in the M treatment. In fact, trends for investment were steadier (and decreasing) in M than in P.

5.4. Answers to our research questions and hypothesis

Although this was only a pilot experiment, so the sample was not large enough to be statistically significant, some preliminary thoughts can be expressed on our hypotheses. H1 was partially confirmed: there seemed to be a treatment effect in terms of the choice of activity cards and in the distribution of individual payoffs, but not in terms of contributions: the groups in M treatment earned more, but there was more of a gap between players. H2 was not confirmed. On the contrary, compared to another collaborative activity in a group, participatory modelling seemed to favour free-riding and aggressive behaviour by upstream players (especially P1), while P3 and P4 remained prone to invest even when losing (and allowing P1 to free-ride), despite a certain social sanction behaviour observed in both treatments.

6. Discussion

6.1. Using experiments as simulations

In their paper in *Science*, Janssen et al. (2010) explain that they "*used methods of dynamic decision-making in order to perform controlled experiments that examine the relevant complexity of social-ecological systems*", themselves referring to Dörner (1996) for the use of computerized microworld in experiments about organisation management. Our questioning was on an higher level of abstraction (we reflected on the use of a model to think about the social-ecological system) but we used experimentations in the same way, *i.e.* to represent the relevant complexity of social-ecological systems. In the exercise to clarify the position of these experiments in our questioning, we referred to Guala (2012), who studied the epistemic relations between models, simulations and experiments. In his view of social experiments, we used "hybrid" entities between simulations and experiments: we brought some material from the real world (the human subjects) into the laboratory, but we do not claim that our experiment exactly reproduced a phenomenon of the real world. The Minsky triad makes it explicit that we simulated a model. Using Guala's words, we decided to speak about "simulating experiments". Using models of this nature, we are able to imagine an experimental platform (in the sense of Muniesa and Callon (2007)), which, for instance, by substituting the current cards by value cards where agents could express their views on water management, could serve as a basis for experimental sociology (Richard-Ferroudji, 2008) or for experiments in other social sciences. These models could constitute frontier objects to facilitate dialogue among various specialists of these disciplines in a community of practice at the interface between science, action, and policy-making.

6.2. A new kind of meta-models

The concept of the meta-model, a model of a model, may differ from one community to another and is directly related to the definition given of the concept of 'model'. In the community of theory of modelling and simulation led by Bernard Zeigler (Zeigler et al., 2000), modellers consider models of dynamic systems. In this community, a model is evaluated according to the way it reproduces (or not) the behaviour of the system it represents, within a specific experimental frame. Therefore, a meta-model is considered as another object that has, statistically, the same behaviour as the model (Zeigler et al., 2000), for a given experimental frame, and at a given level of specification.

In Agent-Based-Modelling in ecology or environmental science, modellers have a more conceptual understanding of a model, whereby a meta-model is a set of concepts that constitute a generic model, general enough to be specialized in less abstract (more specific) representations of the system under study (Treuil et al., 2008). In this paper, and following the general framework of the Minsky triad, an object was considered as a meta-model as long as it was used in our reasoning to represent another model used for a specific purpose, by a specific observer. With this definition, we considered an object as a meta-model only if we also modelled the observer, the object modelled, and their interactions.

This definition was particularly suited to the study of ComMod processes, where we assumed that the object modelled (the NRM situation) was modified by the use or creation of the model by the observers. For that reason, the outcomes of a ComMod process are extremely difficult to observe in the real world. With the model of the ComMod triad, it was possible to repeat experiments and measure outcomes in the laboratory.

6.3. Using our approach to learn about ComMod processes

6.3.1. When should this approach be used?

We could not imagine a specific type of questions about the ComMod process (ρ_{oc} in the T' framework presented Figure 1) that would require the use of this approach. Referring to the study presented in this paper on the Kat river ComMod process, we saw that it implied questions about power asymmetries, finding new cooperative arrangements and assessing the impact of the participatory modelling process. There are several ways of studying these questions without building a model of the ComMod process. Some studies have been conducted, for instance, by interviewing several researchers who implemented different ComMod processes (see for instance (Barnaud et al., 2014) for a study about power asymmetries in ComMod processes). Some others analysed several ComMod processes with the same observation protocol (see for instance (Perez et al., 2011) for a study on monitoring and assessing of the impact of ComMod processes). Some others compared ComMod approaches with other participatory methods based on case studies and a shared analysis grid (see for instance (Berthet et al., 2016) about fostering agroecological innovation). On the other hand, we believe that many questions that social scientists have about ComMod processes can be addressed with this approach. However, we know that we will be restricted by the nature of our model. For instance, in order to answer our question, we

can imagine an experimental setting where subjects would follow a complete ComMod loop: a first phase where players play, a second where they build a model and a third where they play again. However, the different possible situations in the first phase would have distilled the results and such an experimental setting would require many more observations.

In fact, the Minsky triad conceptual framework should be used when a model of a ComMod process is built. Thus, the motivations that we can imagine are the same motivations as those that researchers can have to build a model. Varenne (2018) organises the different functions that a simulation model can have in 5 categories: *i.* to ease experimentation, *ii.* to ease comprehensible formulation, *iii.* to ease theory building, *iv.* to ease communication and cooperative building of knowledge, *v.* to ease decision-making and action. We believe that, regardless of the research question about the ComMod process, a model of this process can be built for many reasons included in any of these five categories.

6.3.2. What is the validity and generality of our model?

As in any modelling process, the validity of the model of the ComMod triad depends on the question that we have about the ComMod triad and on the function we give to our model in our questioning. In the introduction, we stated that our aim was to ease experimentation: as, for many reasons explained above, we cannot reproduce the same ComMod process at will, we reproduce it in the laboratory and study it *in vitro*. However, the question we had about the ComMod processes was very generic. Consequently, the model of the NRM situation that we used to represent the Kat river NRM situation was very simple and very different from the Kat river situation. We actually used the Kat river situation to induce a generic model of ComMod processes that helped us to reflect upon a generic question we had about ComMod processes in general. Thus, the results of our experiment will not teach us many things about the Kat river situation, but more about a general theoretical hypothesis about the effect of ComMod processes in natural resources management issues. In other words, our model of the NRM situation represented a common and generic problem in water management and could certainly be used to reflect upon many specific ComMod processes in a rather abstract way. We believe that this approach is well suited to addressing generic and theoretical questions about the impact of a modelling activity in a ComMod process, firstly because we can generalize situations and secondly, we can repeat experiments at will. However, the knowledge built with these models,

the results and demonstrations made, will remain theoretical and will need to be confirmed by studies in the field on real ComMod processes. We consider our model of the ComMod triad as a launchpad for thinking about ComMod processes. In a theory-building perspective, the more detailed our models of the ComMod triad are, the richer will be the discussions that we can have about them. For instance, a salient question about ComMod processes is the way they interfere with existing institutions (formal or informal) that frame the actions and perceptions of stakeholders. We plan to continue developing the AnaWAG platform in order to use T^* models to represent these institutions. We are confident that this task is possible because the WAG modeling kit proposes a way of representing such institutions (Abrami et al., 2012), and extensive literature is available to describe these institutions based on a common analytical framework proposed by Ostrom (1990). A framework already exists for modelling these institutions in agent-based models using the framework proposed by E. Ostrom (Ghorbani et al., 2013).

7. Conclusion

The work presented in this paper presents a proof of concept showing that the general framework of the Minsky triad is both necessary and well suited to exploring theoretical questions about companion modeling processes. We did not perform the full simulating experiment that we designed and only have the results from a pilot experiment. However, we were already able to see in our model that companion modelling could have an effect on resource management (it was our first hypothesis): in the way we modelled companion modelling, we observed that it increased the efficiency of resource management. We also observed that in the way that we modelled Com-Mod processes, the participatory modelling activity increased the inequality among stakeholders, compared to another collaborative activity. We found several possible explanations for this observation and we need to perform the full experiment to discriminate between them. It is interesting to see that this observation gives rise to new hypothesis on the effects of companion modelling processes. For instance, we believe that this increased inequality is maybe due to the fact that participants are more cooperative and that this decreases the "social sanction" effect assumed to regulate inequality according to the economic theory.

8. Software and data availability

The model code and data used is published on the ComSES platform (Bonté et al., 2019) with the documentation presented in Appendix D below. All the software packages used are free of charge and open-source (Platform: NetLogo 5.3.1, Programming Language: NetLogo, Operating System: Platform Independent, Model code licensed Under: GNU GPL, Version 3). NetLogo software is authored by Uri Wilensky (Email: uri@northwestern.edu. Phone: 847-467-3818. Fax: 847-491-8999. Offices: Annenberg Hall 337. CCL Lab Phone: 847-467-7593. Ford Lab Phone: 847-467-2838). The AnaWAG platform has been programmed under the NetLogo software by Bruno Bonté and Mamadou Ciss Diallo who are authors of this paper (see contact information in the authors' section).

9. References

Abrami, G., Ferrand, N., Ducrot, R., Morardet, S., Hassenforder, E., Garin, P., Bonté, B., Robin, P., Aquae-Gaudi, W., 2016. Paper and pebbles sim-

- ulations and modelling for the governance of socio-environmental systems: a review of 8 years of experimenting with the wat-agame toolkit. In: Proceedings of the 8th International Congress on Environmental Modelling and Software met in Toulouse. p. 137.
- Abrami, G., Ferrand, N., Morardet, S., Murgue, C., Popova, A., De Fooij, H., Aquae-Gaudi, W., 2012. Wat-a-game, a toolkit for building role-playing games about integrated water management. In: R. Seppelt, A.A. Voinov, S. Lange, D. Bankamp (Eds.) (2012): International Environmental Modelling and Software Society (iEMSs) 2012 International Congress on Environmental Modelling and Software. Managing Resources of a Limited Planet: Pathways and Visions under Uncertainty, Sixth Biennial Meeting, Leipzig, Germany.
- Anderies, J., Janssen, M., Lee, A., Wasserman, H., 2013. Environmental variability and collective action: Experimental insights from an irrigation game. *Ecological Economics* 93, 166–176.
- Barnaud, C., D’Aquino, P., Daré, W., Fourage, C., Mathevet, R., Trébuil, G., 2014. Companion Modelling: A Participatory Approach to Support Sustainable Development. QUAE éditions, Ch. Power asymmetries in companion modelling processes, pp. 127–153.
- Barreteau, O., 2003a. The joint use of role-playing games and models regarding negotiation processes: Characterization of associations. *JASSS* 6 (2).
- Barreteau, O., 2003b. Our companion modelling approach. *JASSS* 6 (2).
- Berthet, E., Barnaud, C., Girard, N., Labatut, J., Martin, G., 2016. How to foster agroecological innovations? a comparison of participatory design methods. *Journal of Environmental Planning and Management* 59 (2), 280–301.
- Bonté, B., Farolfi, S., Gaudi, W., Diallo, M. C., Abrami, G., 2019. ana-wag, version 1.7.0. CoMSES Computational Model Library.
URL <https://doi.org/10.25937/5j66-e528>
- Bonté, B., Müller, J.-P., Duboz, R., 2012. Modeling the minsky triad: A framework to perform reflexive m&s studies. In: Proceedings of the Winter Simulation Conference. WSC ’12. Winter Simulation Conference, pp. 236:1–236:12.

- Boring, E., 1950. *A History of Experimental Psychology* (2nd ed.). Prentice-Hall.
- Czap, N., Czap, H., Khachatryan, M., Lynne, G., Burbach, M., 2012. Walking in the shoes of others: Experimental testing of dual-interest and empathy in environmental choice. *Journal of Socio-Economics* 41 (5), 642–653.
- Desolé, M., 2011. *Theorie des jeux, jeux de roles et experimentations pour la gestion de l'eau : etude experimentale des effets du contexte sur les resultats d'un jeu de roles*. Ph.D. thesis, Montpellier SupAgro.
URL <http://www.theses.fr/2011NSAM0004>
- Dörner, D., 1996. *The Logic of Failure*. Perseus Books, Reading, MA.
- Druckman, J. N., Green, D. P., Kuklinski, J. H., Lupia, A. (Eds.), 2011. *Cambridge handbook of experimental political science*. Cambridge Univ. Press, Cambridge.
- Dubois, E., Barreteau, O., Souchère, V., 2013. An agent-based model to explore game setting effects on attitude change during a role playing game session. *Journal of Artificial Societies and Social Simulation* 16 (1), 2.
- Eber, N., Willinger, M., 2005. *L'Economie Experimentale*. Collection "Reperes", Editions La Decouverte, Paris.
- Étienne, M., 2011. *Compainon Modelling: A Participatory Approach Supporting Sustainable Development*. QUAE éditions.
- Falk, A., Heckman, J. J., 10 2009. Lab experiments are a major source of knowledge in the social sciences. *Science* 326 (5952), 535–538.
- Farolfi, S., Désolé, M., Rio, P., 2014. Influence of context on player behavior: Experimental assessment. *Simulation and Gaming* 45, 627–665.
- Farolfi, S., Müller, J.-P., Bonté, B., 2010. An iterative construction of multi-agent models to represent water supply and demand dynamics at the catchment level. *Environmental Modelling and Software* 25 (10), 1130–1148.
- Farolfi, S., Rowntree, K., 2006. Accompanying local stakeholders in negotiation processes related to water allocation through simulation models and role-playing games: An experience from south africa. *EMPOWERS Regional Symposium: End Users Ownership and Involvement in IWRM*.

- Ghorbani, A., Bots, P., Dignum, V., Dijkema, G., 2013. Maia: A framework for developing agent-based social simulations. *JASSS* 16 (2).
- Guala, F., 2012. *Model-Based Reasoning: Science, Technology, Values*. Springer US, Ch. 1 Models , Simulations , and Experiments.
- Harrison, G., List, J., 2004. Field experiments. *Journal of Economic Literature* 42 (4).
- Hassenforder, E., Pittock, J., Barreteau, O., Daniell, K., Ferrand, N., 2016. The meppp framework: A framework for monitoring and evaluating participatory planning processes. *Environmental Management* 57 (1), 79–96.
- Janssen, M., Anderies, J., Cardenas, J.-C., 2011a. Head-enders as stationary bandits in asymmetric commons: Comparing irrigation experiments in the laboratory and the field. *Ecological Economics* 70 (9), 1590–1598.
- Janssen, M., Anderies, J., Joshi, S., 2011b. Coordination and cooperation in asymmetric commons dilemmas. *Experimental Economics* 14 (4), 547–566.
- Janssen, M., Holahan, R., Lee, A., Ostrom, E., 2010. Lab experiments for the study of social-ecological systems. *Science* 328 (5978), 613–617.
- Jones, N., Perez, P., Measham, T., Kelly, G., D’Aquino, P., Daniell, K., Dray, A., Ferrand, N., 2009. Evaluating participatory modeling: Developing a framework for cross-case analysis. *Environmental Management* 44 (6), 1180–1195.
- Laury, S., Taylor, L., 2008. Altruism spillovers: Are behaviors in context-free experiments predictive of altruism toward a naturally occurring public good? *Journal of Economic Behavior and Organization* 65 (1), 9–29.
- Levitt, S., List, J., 2007. What do laboratory experiments measuring social preferences reveal about the real world? *Journal of Economic Perspectives* 21 (2), 153–174.
- Michel-Guillou, E., Moser, G., 2006. Commitment of farmers to environmental protection: From social pressure to environmental conscience. *Journal of Environmental Psychology* 26 (3), 227–235.
- Minsky, M., 1965. Matter, mind and models. In: *Proceedings of IFIP Congress*. pp. 45–49.

- Moreno, J. L., 1954. Sociometry and experimental sociology. *Sociometry* 17 (4), 358–363.
- Muniesa, F., Callon, M., 2007. Economic experiments and the construction of markets. In: Donald MacKenzie, F. M., Siu, L. (Eds.), *Do Economists Make Markets? On the Performativity of Economics*. Princeton University Press, pp. 163–189.
- Ostrom, E., 1990. *Governing the commons: the evolution of institutions for collective action*. Cambridge University Press.
- Perez, P., Aubert, S., Daré, W., Ducrot, R., Jones, N., Queste, J., Trébuil, G., Paassen, A. V., 2011. Companion Modelling. A participatory approach to support sustainable development. Quae, Ch. Assessment and monitoring of the effects of the ComMod approach.
- Popper, K. R., 1959. *The logic of scientific discovery*. Hutchinson & Co.
- Richard-Ferroudji, A., Mar. 2008. The appropriation of devices used for a local and participative management of water. Theses, Ecole des Hautes Etudes en Sciences Sociales (EHESS).
URL <http://www.theses.fr/2008EHES0144>
- Treuil, J.-P., Drogoul, A., Zucker, J.-D., 2008. *Modelisation et simulation a base d'agents - Exemples commentes, outils informatiques et questions theoriques*. Dunod.
- Varenne, F., 2018. *From models to simulations*. Routledge.
- Zeigler, B. P., Kim, T. G., Praehofer, H., 2000. *Theory of modeling and simulation: Integrating Discrete Event and Continuous Complex Dynamic Systems*. Academic Press.

10. Appendix A: Modeling activity

10.1. *Instructions for modelers*

Instructions were distributed to each subject. Then they were asked to read them and an experimenter read them aloud. Instructions changed only in the position assigned to the player (upstream, in the middle, or downstream). We translated the instructions in the paragraph below:

Instructions for modelers. You are part of a group of 4 subjects. You are a farmer who is a member of a user association that manages an irrigated system. Upstream farmers have priority in terms of access to water over those in the middle or downstream. You are a farmer located [in the middle/upstream/downstream] of the irrigated system. Your objective is to build with other farmers a model that represents your irrigated system and will help you discuss system management strategies. You have a kit that allows you to represent an irrigated system with four irrigators and a water source (drilling) positioned upstream of the system. The system is gravity-based, so surface water from the nearest dam enters the upstream irrigated system. Each farmer has an irrigated plot. The following elements are at your disposal to model your system: -A sheet of flipchart; -Felt pens; -Colored post-it notes. You have 15 minutes to build your model.

10.2. Example of model

Figure 10 present an example of model built by the subjects.

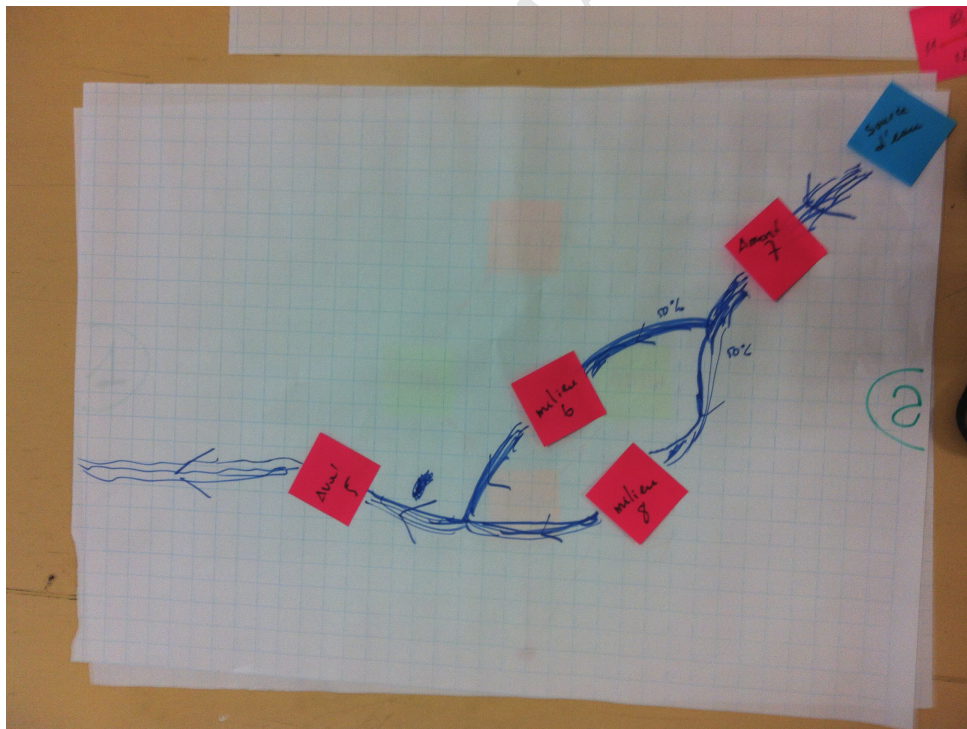

Figure 10: Example of model

11. Appendix B: Puzzle activity

11.1. Instructions for puzzle players

Instructions were distributed to each subject. Then they were asked to read them and an experimenter read them aloud. We translated the instructions in the paragraph below:

Instructions for puzzle players. You are part of a group of 4 subjects. Your goal is to solve a 28-piece puzzle together in 15 minutes. You have an illustration containing the solution of the puzzle divided into 4 quadrants. Each subject has a quadrant and cannot share it with the other three subjects. One piece of the puzzle at a time can be moved (exchange with another piece). Only one player at a time can work on the puzzle (each in turn clockwise).

11.2. Puzzle

The image ask to rebuild is presented in Figure 11. It was printed on a A3 page.



Figure 11: Puzzle image

12. Appendix C: Role playing game instructions

Instructions

The experience you are about to participate in is intended for the study of decision-making. We ask you to read the instructions carefully, they should allow you to fully understand the experience. When all participants have read these instructions, an experimenter will read them aloud. All your decisions will be treated anonymously. You will indicate your choices to the computer you are sitting in front of. From now on, we ask you to stop talking. If you have a question, raise your hand and an experimenter will come and answer you in private.

During the experiment you will accumulate earnings, expressed in experimental currency units, the WAG. At the end of the experiment your accumulated earnings will be converted into euros at the conversion rate: 1 WAG = 1 euro.

General framework

You are one of four members of a group of farmers in an irrigated system who share a borehole to irrigate their fields. The amount of water produced by the borehole depends on the maintenance provided by the group: the more the group contributes to the maintenance, the more water the borehole will produce.

The fields of the four farmers are aligned along an irrigation channel, water arrives first in the fields of the first, then in the second, etc. Your position (1, 2, 3 or 4) will be indicated at the beginning of the game and will remain unchanged until the end of the game.

You will be able to use the water from the canal to carry out your activities. These activities are represented by "activity cards" that you can install on your field. The activities have a cost (1 to 2 WAGs depending on the activities) and generate revenue (1 to 6 WAGs) as explained in the glossary.

The game is repeated 15 times. You will have 5 training rounds beforehand which will not count in your remuneration.

Water availability

There are two sources of water: surface water (rain) and groundwater from drilling.

- By default one unit of surface water comes from the rain every turn.
- The amount of water produced by drilling each tower depends on the amount of money invested by the group each tower in its maintenance. Figure 1 shows the number of units of produced water (on the ordinate) as a function of the total contribution invested by the group (on the abscissa).

Outline of a turn

A turn lasts 30 seconds. You will have a countdown at the top right of the screen. Each turn you can invest up to 5 WAGs: 0 to 3 WAGs in drilling maintenance (action 1) and 0 to 2 WAGs in an "activity card" (action 2).

Action 1: To invest in drilling maintenance you must position the cursor under the corresponding number (see image 1).

Action 2: your field is highlighted and you can choose the activity you want to perform by clicking on one of the cards in the left column (see image 1).

At the end of the tour, the water (rain + drilling + possibly water produced by the activities) flows from the upstream (top left) to the downstream (bottom right) and is gradually distributed in the fields.

Gain for each turn

Your gain is determined by the income generated by the chosen activity minus the investment in drilling maintenance and the cost of the activity card.

Example:

You contribute up to 1 WAG to the maintenance of the borehole and choose map 4. This requires two water units and an investment of 1 WAG and in return it generates an income of 4 WAGs.

- If at least two units of water reach the field, your gain is 4 (income) - 1 (activity cost) - 1 (drilling investment) = 2 WAGs.

- If, on the other hand, less than two units of water reach the field, your gain is 0 (income) - 1 (activity cost) - 1 (drilling investment) = -2 WAGs.

Figure 1: Drilling water production based on the group's contribution

Units
of water produced by drilling

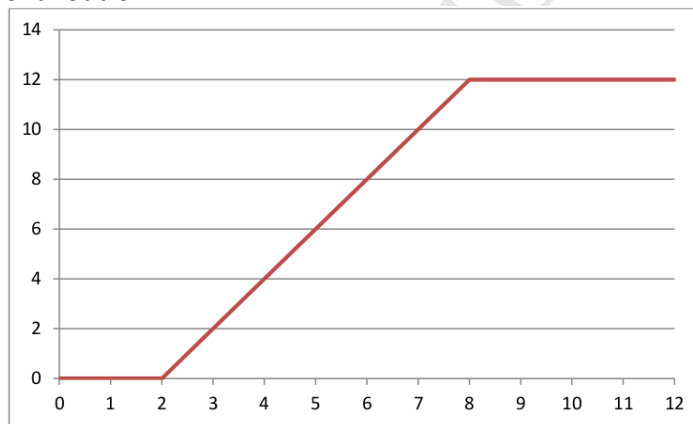

Contribution of the group to the maintenance of
the drilling
(in WAGS)

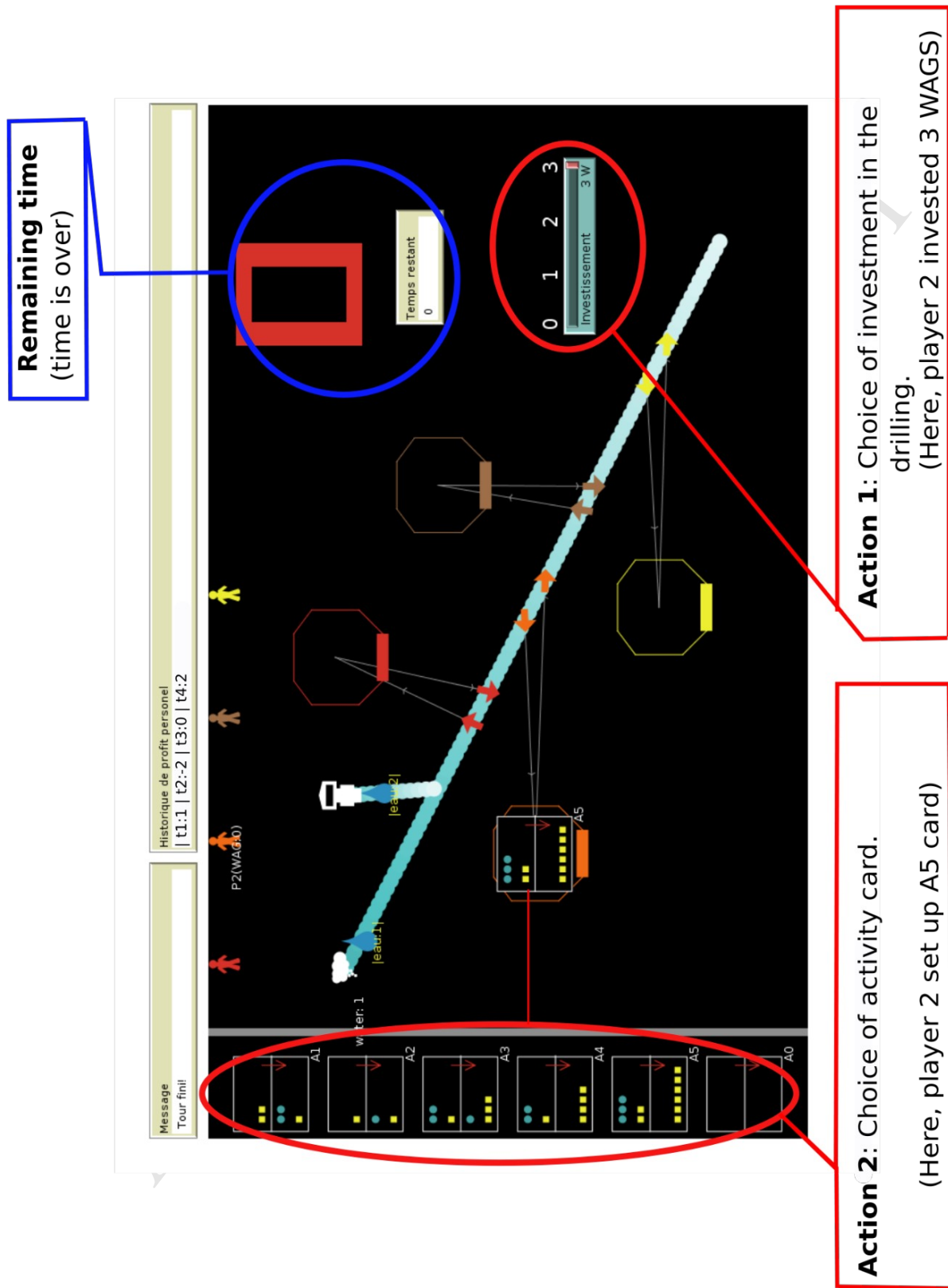

Image 1: Interface – Actions

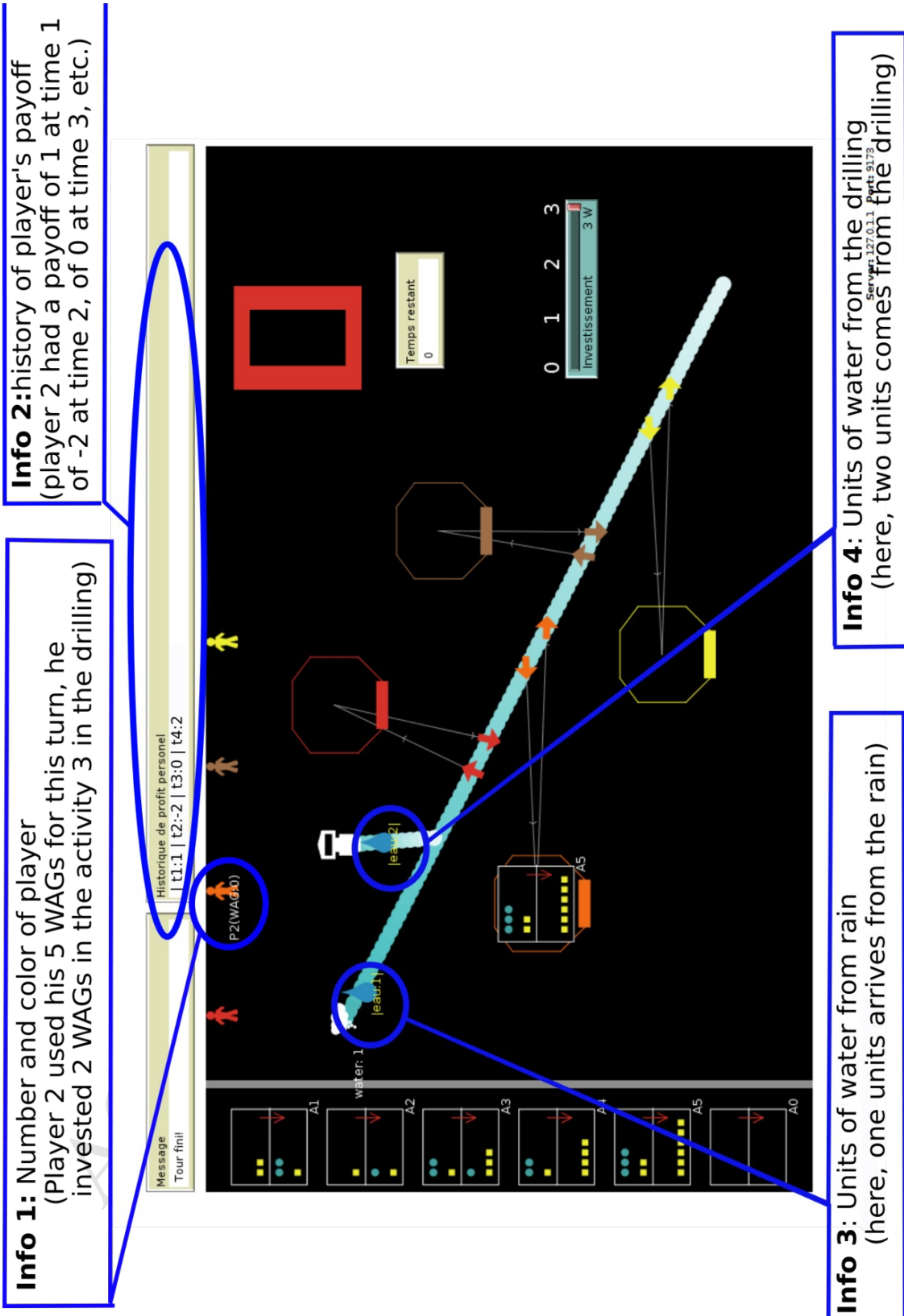

Image 2: Interface – Informations

GLOSSAIRE



Field:

The position of your land in the irrigated system is represented by an exaggeration of your color.



Water:

Water is represented by drops each representing one or more units of water (here a unit of water). In the activity maps, the water needs and the water discharged is symbolized by blue dots (●).

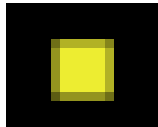

WAG:

WAGs are represented in the activity cards by yellow squares. They represent your economic resource. Your actions in the game will cause you to win or lose WAGs each game turn.



Drilling:

Produces water from the borehole.



Rain:

Produces natural surface water.

The activity cards :

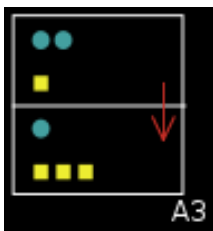

There are 5 different activity cards that you can make on your field. The activity requires a number of WAGs (■) and water units (●) to be realized (upper part of the map). It rejects a certain amount in return and, if it receives all the water it needs, it is successful and produces money (lower part of the map). Once the activity is placed, the number of WAGs necessary for its realization will be deducted from your profit of the corresponding round. If the activity is successful, the money it produces will be less expensive and your contribution to the drilling will be less of a benefit to you.

Example: If a player wants to play the A3 card (above) he must invest 1 WAGs. If it receives two units of water, the activity is successful and the player who installed it will receive 3 WAGs. In addition, a unit of water received by the field will be returned to the irrigated system. Imagine that the player has invested 1 WAG in the maintenance of the borehole and the activity is successful, his profit for this round will be 1 WAG (2 WAGs invested and 3 WAGs won).

13. Appendix D: The AnaWAG device

The AnaWAG device code and documentation can be downloaded from the ComSES model library at the following link <https://doi.org/10.25937/5j66-e528>. Below is the user guide. Do not hesitate to contact authors for any help for use or design of new features.

AnaWAG User Guide

Table of content

- Purpose
- Structure of the AnaWAG device
- Setting experimental parameters (Experimenter)
- Modeling (Experimenter): Design a watershed model
- Play (Experimenter): Organise and run a network game
- Play (Player): Participate to a network game
- Simulate (Experimenter): Run simulations with computerized players
- Download and Installation of AnaWAG
- Details and implementation in NetLogo

Purpose

The AnaWAG device, for “Analyse Wat-A-Game” (WAG), is a computer version of the Wat-A-Game “paper and pebbles” modelling and simulation tool for water management (See Abrami et al., 2012 ¹). It enables to perform the three activities below.

1. Build up a Wat-A-Game model representing a watershed (that may also be seen as an irrigated scheme).
2. Simulate the model by playing it as a network-game in an experimental design.
3. Simulate the model with computer agents instead of players.

The aim is to make possible to perform experiments in the understanding of contextualized experimental economics, in which subjects can build “role playing game” models as the one built during participatory processes and then play to the model they built. In this actual version, AnaWAG is designed to realize the specific experiment presented in a scientific paper under review². However it can be easily reused to design other experiments.

¹Abrami, G., Ferrand, N., Morardet, S., Murgue, C., Popova, A., De Fooij, H., Stefano Farolfi, S., Du Toit, D., Aquae-Gaudi, W., 2012. Wat-a-game, a toolkit for building role-playing games about integrated water management. In: R. Seppelt, A.A. Voinov, S. Lange, D. Bankamp (Eds.) (2012): International Environmental Modelling and Software Society (iEMSs) 2012 International Congress on Environmental Modelling and Software. Managing Resources of a Limited Planet: Pathways and Visions under Uncertainty, Sixth Biennial Meeting, Leipzig, Germany.

²Bonte et al under review.

Structure of the AnaWAG device

We distinguish two kinds of users of the AnaWAG device:

- The experimenter who can:
 - set experimental parameters,
 - build a watershed model,
 - run a simulation with computerized agents,
 - run a game session with human players.
- The players who can:
 - Play a game session.

Entities, state variables and scales of the WAG model

Entities of AnaWAG device model correspond to the entities that exist in the WAG role playing game and in a watershed system in general:

- Players that represent water users,
- Waterpaths that represent the river,
- Fields that represent elementary spatial units,
- Activities that represent uses of resources (water resource and eventually other resources) to produce other resources and that must be installed on a Field entity,
- Pumps that enable to withdraw water from the river to bring it to the Fields,
- Outlets that represent the out-flow from Fields entities to the river,
- Sources of water that brings water to the Waterpaths,
- Water resource that can flow along river path, and
- WAG resources that represent money.

The conceptual model of entities and their state variables is presented in an UML class diagram in Figure below.

AnaWAG Main Entities and state variables

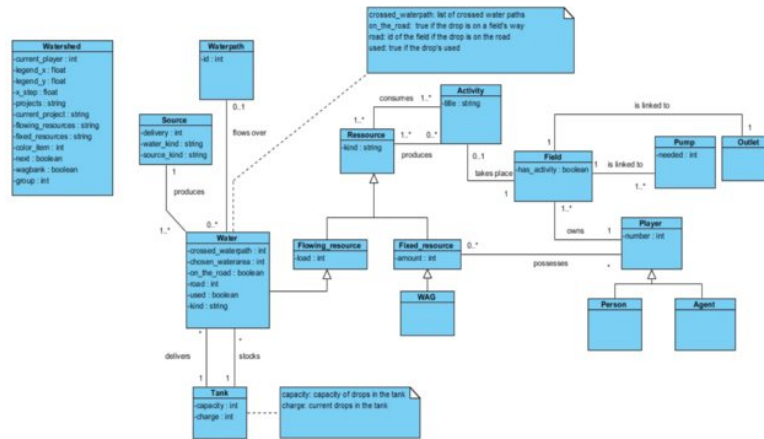

There are three main levels of spatial scale in the WAG modelling language.

- The level of the Field that is the same level of the activity in the spatial scale. It represents the elementary unit, spatially and temporally. Indeed the transformation of resource described by all Activities are processes that occur at the same level of spatial and temporal scale. This level however is not specified at this point, it depends on each WAG model. In the model used in (*Bonte et al, under review*), which is theoretical, we can consider that the spatial level is a plot of an watershed.
- The level of the Farm or Set of Fields owned by a Player is the spatial scale of strategic decision making since it determines the stakes of each players. In the model used in (*Bonte et al, under review*), each Player own one or several plots.
- The level of the Watershed is the greater level that contains all entities. In the model used in (*Bonte et al, under review*), it represents a watershed managed by four farmers and supplied by one natural source of water (rain from upstream) and one artificial source of water (pumped from an aquifer).

The temporal resolution is the year or the time to execute an Activity. It corresponds to a “round” of the game. The temporal extent is the number of rounds.

Setting experimental parameters (Experimenter)

The first feature enables the experimenter to set up the parameters of a session (group numbers, duration, water supply parameters) and to choose the activity to perform (modelling, simulation or network game). The corresponding interface is the general interface displayed below opened when the file is open.

AnaWAG Main Interface: Set parameters and choose activity

The screenshot shows a NetLogo window titled "main - NetLogo (/home/bonte/git/ana-wag-comses/ana-wag)". The interface has a menu bar with "File", "Edit", "Tools", "Zoom", "Tabs", and "Help". Below the menu bar are tabs for "Interface", "Experiment parameters", "Info", "Code", and "source_class.nls". The main content area is divided into three sections:

- 1. Define the context**: Contains six input fields with the following labels and values:

G(i)	G(j)	nb-play...	initial-W...	rounds	max investment
1	1	4	5	20	3
- 2. Define the natural water parameters**: Contains three input fields with the following labels and values:

min natural water	max natural water	forecast error
1	10	0.2
- 3. Choose the treatment's action**: Contains three buttons: "Modeling" (red), "Play" (blue), and "Simulate" (green).

- To change parameters values, replace the value by the value of your choice and press "enter".
- To start an activity, click on the button.

Parameters to set are the following:

Define the context

- **i** and **j** : Indexes used to save data and relate it to a simulation or a group of players
- **nb-players**: Number of players/agents in the watershed.
- **initial-W**: Number of units of money at the initialisation of each round.
- **rounds**: Maximal number of rounds during a simulation or a game.
- **max-investment**: Maximal possible investment in the water harvesting public infrastructure.

Define the natural water parameters

- **min natural water:** Minimum natural water in random natural sources
- **max natural water:** Maximum natural water in random natural sources
- **forecast error:** Error factor in natural water forecasting

Choose activity Choose one of the following activity described in the next sections of the guide:

- Modeling (Experimenter): Design a watershed model
- Play (Experimenter): Organise and run a network game
- Play (Player): Participate to a network game
- Simulate

Modeling (Experimenter): Design a model of watershed

The Modeling feature enables to realise the model of an watershed model as presented in (Bonte et al., Under review³). Figure below presents the interface in which an experimenter already started to draw a water shed with 4 players/agents, a field, a river reach and a water source (visible in the drawing area). The user may load or save his watershed and modify existing watersheds.

AnaWAG Modeling Interface: Draw your watershed

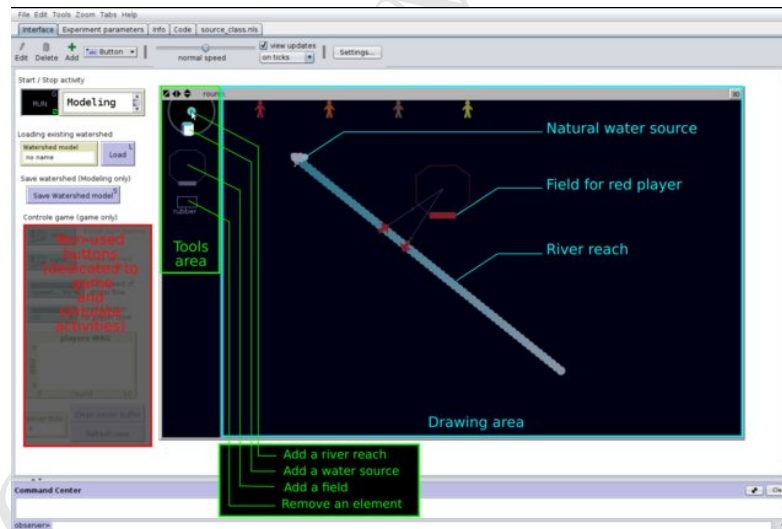

-Click on “RUN” button to start the activity. - Draw your watershed by drag and dropping elements from the tool area to the drawing area, eventual options will be proposed when you install elements (owner of the fields, kind of the water sources, ...). - Save or load your watershed with corresponding buttons.

³Bonte et al under review.

Play (Experimenter): Organise and run a network game

The **Play** activity enables to realise the network game model activity, organised as a client server architecture based on HubNet in which:

- When clicking on the **Play** button, a windows open and the experimenter must first start a network session to which players will connect. He or she must just enter a session name and click on the “start” button (see Figure below).

Starting a network session window.



- Enter session name.
- Choose to broadcast session so that players can see the session when they open clients. -Click on start.

- Once the session is started the experimenter can monitor and manage the clients connexions (see interface below).

Managing client connexions with HubNet control center interface.

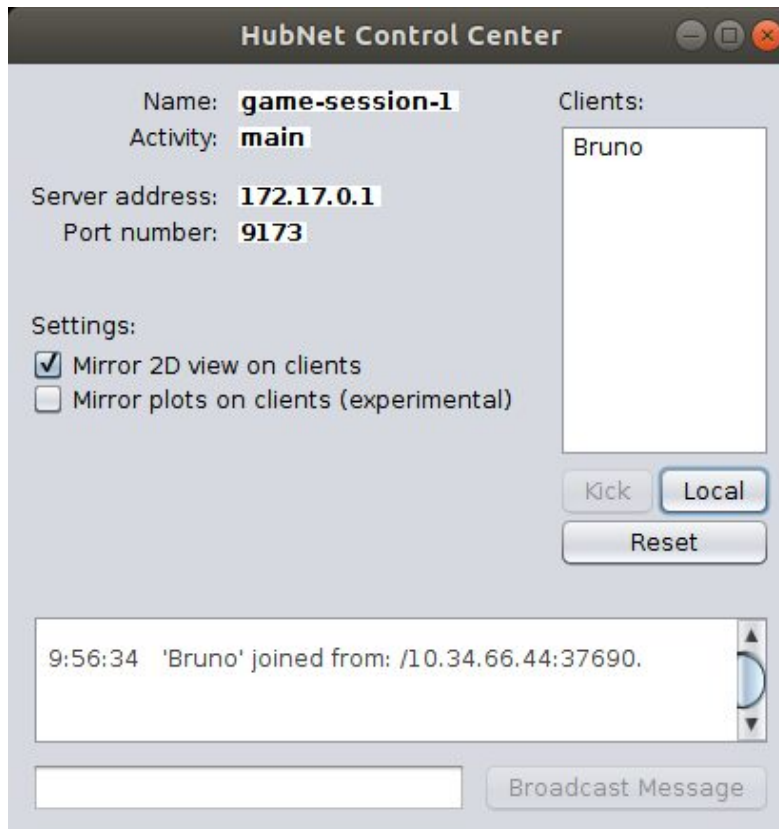

- You can see connected clients (here one client “Bruno”) and disconnect them eventually (kick button).
- You can see server address and port.
- You can open local client connexions (local button).
- You can send messages to clients. ...

- The experimenter manages the server interface (see Figure below) with which he can monitor players actions and decide to start, pause or resume the game. A game session is by default initialized with the default “example” watershed but you may load another existing watershed.

The AnaWAG Play Interface (experimenter): Manage a game session

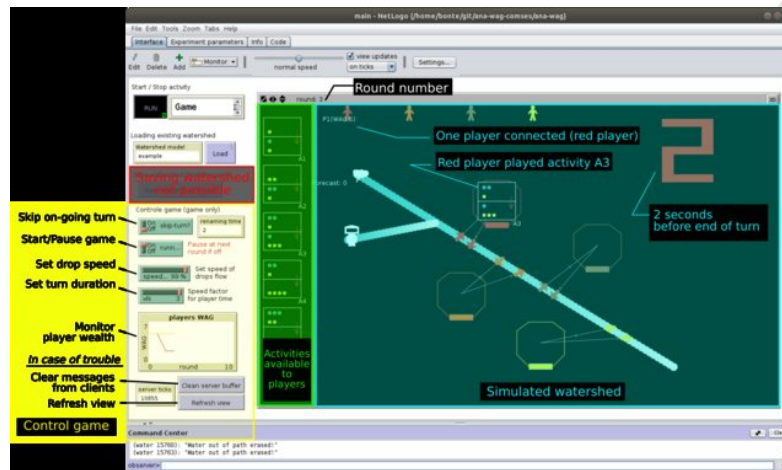

- The **example** watershed model is loaded by default, if you want to use another one you need to click on load button and choose the watershed model you want to play.
- When you click on RUN button, each connected client is associated to a player of the watershed by order of connexion (supernumerar clients are not associated..). Here there is only one client connected (Bruno) and he is associated to the red player (Player 1).
- Before starting the game, you may set the speed of drops (they run through the watershed at the end of each round) and the round duration (3 possibilities).
- There may be some issues with client messages sent during pauses, if this happens, click on “Clean server buffer” and set back the start/pause switch **On**.
- There may be some issues in visualizing the space (all or part in gray), if it happens click on “Refresh view”.
- The players are presented in next section: (see next section)).

Play (Player): Participate to a network game

The players manage their client interface with which a player can at each round: monitor his own activities and status, choose his participation to the public infrastructure and change the activities to implement on his plots by clicking on a plot and choosing an activity card in the legend.

- Client must first run the HubNet client software (executable file in the root of NetLogo installation folder that you just need to copy and paste on your computer), and connect to the server using the HubNet client connexion interface displayed below.

Connexion with HubNet client connexion interface



The screenshot shows the HubNet client interface. It has a title bar with the text "HubNet" and a close button. Below the title bar, there are three input fields: "User name:" with the text "Bruno", "Server:" with the text "10.34.66.44", and "Port:" with the text "9173". Below these fields is a table with four columns: "Name", "Activity", "Server", and "Port". The table contains one row with the following data: "game-session-1", "main", "10.34.66.44", and "9173". At the bottom right of the interface is an "Enter" button.

Name	Activity	Server	Port
game-session-1	main	10.34.66.44	9173

- Choose the session you want to connect to (or enter manually the server adress and port)
- Enter a user name
- Click on the “enter” button

- Once connected, the player waits for the game to start and then he can start playing by playing an activity card on each of his field and choosing how much he wants to contribute to the water harvesting public infrastructure. (for instance the interface of player 1 (Bruno Client) in Figure below, where player 4 just changed the activity card standing on his first plot).

Client game interface

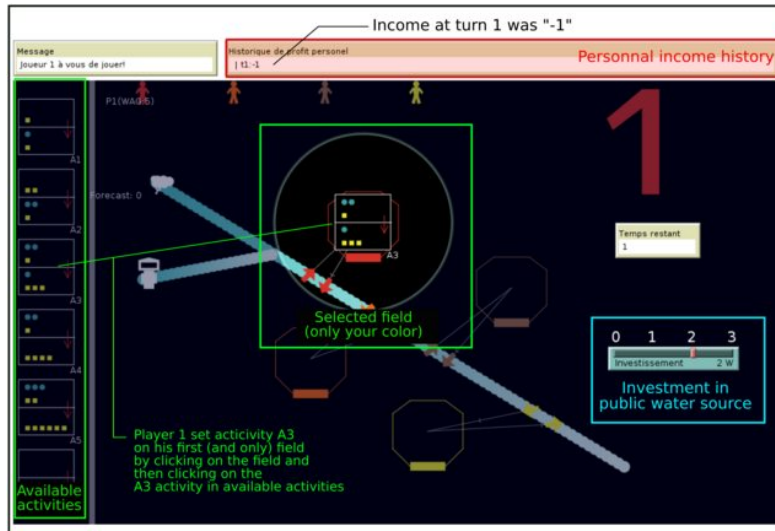

- Select your investment in public water source (here player 1 chooses 2) - for each one of your fields (fields of your color) set the activity by clicking on the field (it becomes highlighted with a white halo) and then clicking on the activity you want to settle.
- You can see how much time is remaining for the current round (here 1 second).
- You can see your income for previous rounds (here only one previous round t1, where your income was “-1”).
- You can see your actual wealth under the figure representing you in the top of the screen (here the red player owns 5 WAGs).

AnaWAG User Guide

Table of content

- Purpose
- Structure of the AnaWAG device
- Setting experimental parameters (Experimenter)
- Modeling (Experimenter): Design a watershed model
- Play (Experimenter): Organise and run a network game
- Play (Player): Participate to a network game
- Simulate (Experimenter): Run simulations with computerized players
- Download and Installation of AnaWAG
- Details and implementation in NetLogo

Purpose

The AnaWAG device, for "Analyse Wat-A-Game" (WAG), is a computer version of the Wat-A-Game "paper and pebbles" modelling and simulation tool for water management (See Abrami et al., 2012¹). It enables to perform the three activities below.

1. Build up a Wat-A-Game model representing a watershed (that may also be seen as an irrigated scheme).
2. Simulate the model by playing it as a network-game in an experimental design.
3. Simulate the model with computer agents instead of players.

The aim is to make possible to perform experiments in the understanding of contextualized experimental economics, in which subjects can build "role playing game" models as the one built during participatory processes and then play to the model they built. In this actual version, AnaWAG is designed to realize the specific experiment presented in a scientific paper under review². However it can be easily reused to design other experiments.

1 Abrami, G., Ferrand, N., Morardet, S., Murgue, C., Popova, A., De Fooij, H., Stefano Farolfi, S., Du Toit, D., Aquae-Gaudi, W., 2012. Wat-a-game, a toolkit for building role-playing games about integrated water management. In: R. Seppelt, A.A. Voinov, S. Lange, D. Bankamp (Eds.) (2012): International Environmental Modelling and Software Society (iEMSs) 2012 International Congress on Environmental Modelling and Software. Managing Resources of a Limited Planet: Pathways and Visions under Uncertainty, Sixth Biennial Meeting, Leipzig, Germany.

2 Bonte et al under review.

Structure of the AnaWAG device

We distinguish two kinds of users of the AnaWAG device:

- The experimenter who can:
 - set experimental parameters,
 - build a watershed model,
 - run a simulation with computerized agents,
 - run a game session with human players.
- The players who can:
 - Play a game session.

Entities, state variables and scales of the WAG model

Entities of AnaWAG device model correspond to the entities that exist in the WAG role playing game and in a watershed system in general:

- Players that represent water users,
- Waterpaths that represent the river,
- Fields that represent elementary spatial units,
- Activities that represent uses of resources (water resource and eventually other resources) to produce other resources and that must be installed on a Field entity,
- Pumps that enable to withdraw water from the river to bring it to the Fields,
- Outlets that represent the out-flow from Fields entities to the river,
- Sources of water that brings water to the Waterpaths,
- Water resource that can flow along river path, and
- WAG resources that represent money.

The conceptual model of entities and their state variables is presented in an UML class diagram in Figure below.

AnaWAG Main Entities and state variables

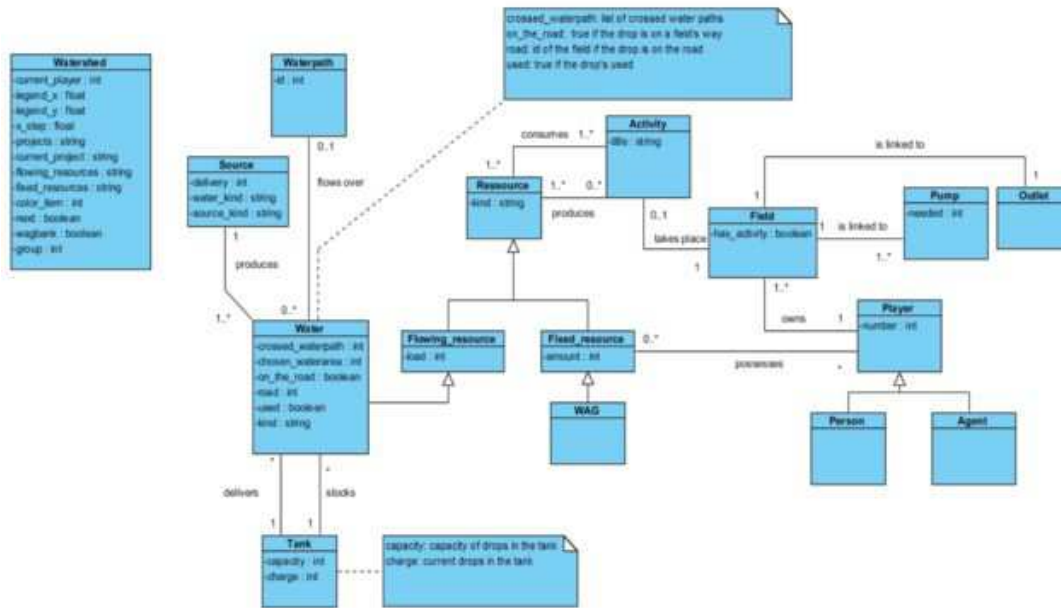

There are three main levels of spatial scale in the WAG modelling language.

- The level of the Field that is the same level of the activity in the spatial scale. It represents the elementary unit, spatially and temporally. Indeed the transformation of resource described by all Activities are processes that occur at the same level of spatial and temporal scale. This level however is not specified at this point, it depends on each WAG model. In the model used in (*Bonte et al, under review*), which is theoretical, we can consider that the spatial level is a plot of an watershed.
- The level of the Farm or Set of Fields owned by a Player is the spatial scale of strategic decision making since it determines the stakes of each players. In the model used in (*Bonte et al, under review*), each Player own one or several plots.
- The level of the Watershed is the greater level that contains all entities. In the model used in (*Bonte et al, under review*), it represents a watershed managed by four farmers and supplied by one natural source of water (rain from upstream) and one artificial source of water (pumped from an aquifer).

The temporal resolution is the year or the time to execute an Activity. It corresponds to a "round" of the game. The temporal extent is the number of rounds.

Setting experimental parameters (Experimenter)

The first feature enables the experimenter to set up the parameters of a session (group numbers, duration, water supply parameters) and to choose the activity to perform (modelling, simulation or network game). The corresponding interface is the general interface displayed below opened when the file is open.

AnaWAG Main Interface: Set parameters and choose activity

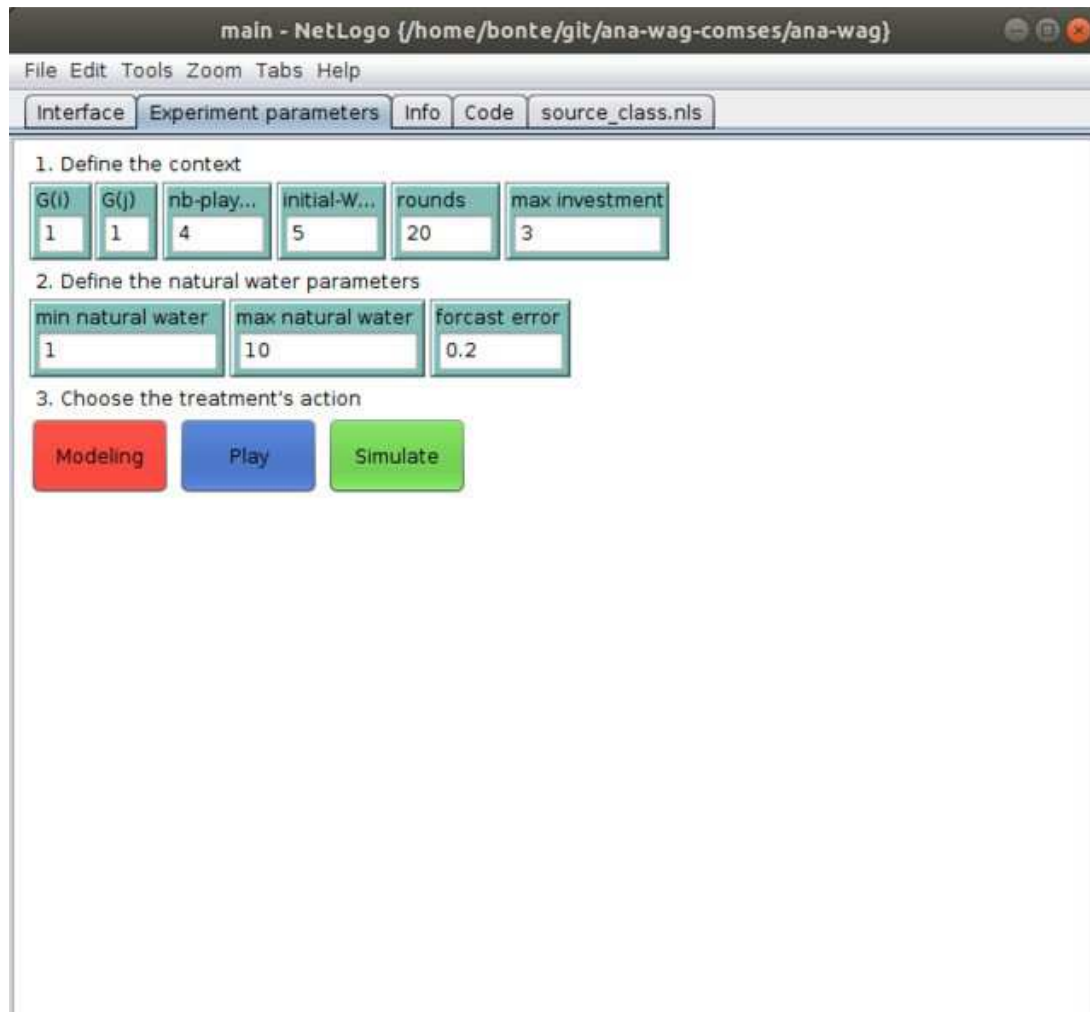

- To change parameters values, replace the value by the value of your choice and press "enter".
- To start an activity, click on the button.

Parameters to set are the following:

Define the context

- **i** and **j** : Indexes used to save data and relate it to a simulation or a group of players
- **nb-players**: Number of players/agents in the watershed.
- **initial-W**: Number of units of money at the initialisation of each round.
- **rounds**: Maximal number of rounds during a simulation or a game.
- **max-investment**: Maximal possible investment in the water harvesting public infrastructure.

Define the natural water parameters

- **min natural water:** Minimum natural water in random natural sources
- **max natural water:** Maximum natural water in random natural sources
- **forecast error:** Error factor in natural water forecasting

Choose activity Choose one of the following activity described in the next sections of the guide:

- Modeling (Experimenter): Design a watershed model
- Play (Experimenter): Organise and run a network game
- Play (Player): Participate to a network game
- Simulate

Modeling (Experimenter): Design a model of watershed

The Modeling feature enables to realise the model of an watershed model as presented in (Bonte et al., Under review³). Figure below presents the interface in which an experimenter already started to draw a water shed with 4 players/ agents, a field, a river reach and a water source (visible in the drawing area). The user may load or save his watershed and modify existing watersheds.

AnaWAG Modeling Interface: Draw your watershed

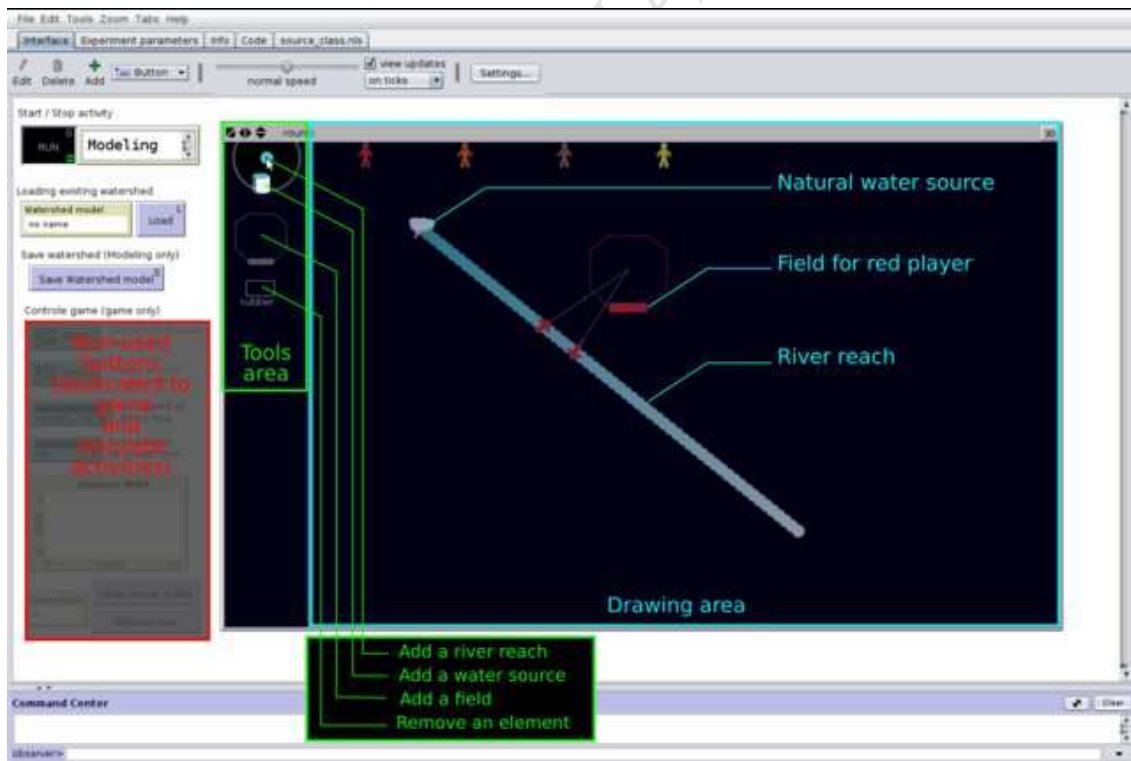

-Click on "RUN" button to start the activity. - Draw your watershed by drag and dropping elements from the tool area to the drawing area, eventual options will be proposed when you install elements (owner of the fields, kind of the water sources, ...). - Save or load your watershed with corresponding buttons.

Play (Experimenter): Organise and run a network game

The **Play** activity enables to realise the network game model activity, organised as a client server architecture based on HubNet in which:

- When clicking on the **Play** button, a windows open and the experimenter must first start a network session to which players will connect. He or she must just enter a session name and click on the "start" button (see Figure below).

Starting a network session window.



- Enter session name.
- Choose to broadcast session so that players can see the session when they open clients. -Click on start.
- Once the session is started the experimenter can monitor and manage the clients connexions (see interface below).

Managing client connexions with HubNet control center interface.



- You can see connected clients (here one client "Bruno") and disconnect them eventually (kick button).
- You can see server address and port.
- You can open local client connexions (local button).
- You can send messages to clients. ...
- The experimenter manages the server interface (see Figure below) with which he can monitor players actions and decide to start, pause or resume the game. A game session is by default initialized with the default "example" watershed but you may load another existing watershed.

The AnaWAG Play Interface (experimenter): Manage a game session

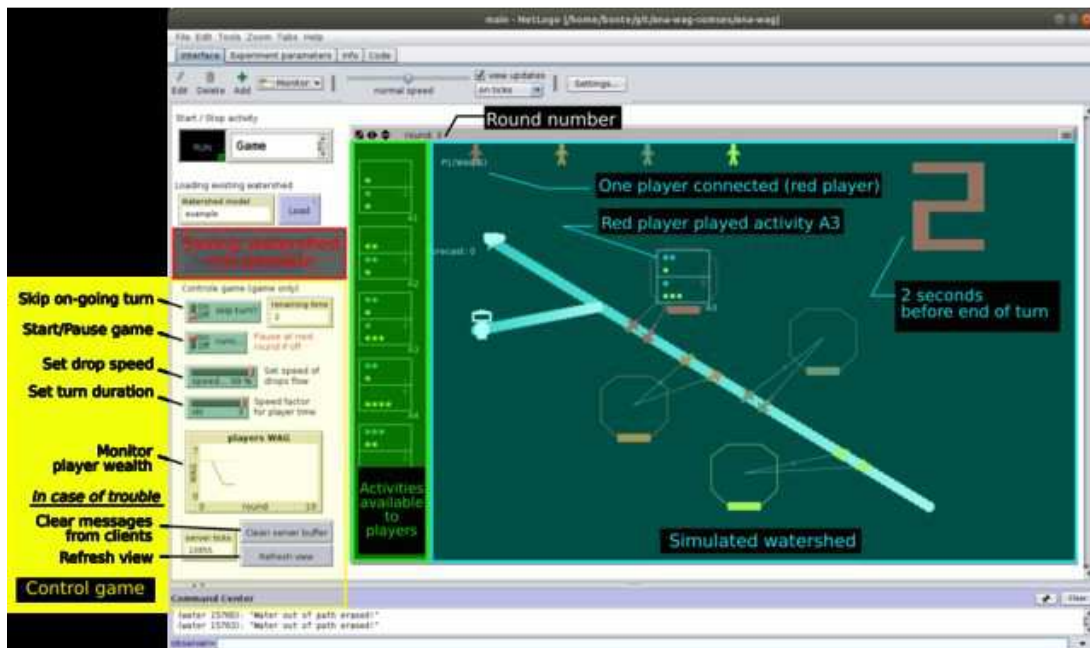

- The **example** watershed model is loaded by default, if you want to use another one you need to click on load button and choose the watershed model you want to play.
- When you click on RUN button, each connected client is associated to a player of the watershed by order of connexion (supernumerar clients are not associated..). Here there is only one client connected (Bruno) and he is associated to the red player (Player 1).
- Before starting the game, you may set the speed of drops (they run through the watershed at the end of each round) and the round duration (3 possibilities).
- There may be some issues with client messages sent during pauses, if this happens, click on "Clean server buffer" and set back the start/pause switch **On**.
- There may be some issues in visualizing the space (all or part in gray), if it happens click on "Refresh view".
- The players are presented in next section: (see next section)).

Play (Player): Participate to a network game

The players manage their client interface with which a player can at each round: monitor his own activities and status, choose his participation to the public infrastructure and change the activities to implement on his plots by clicking on a plot and choosing an activity card in the legend.

- Client must first run the HubNet client software (executable file in the root of NetLogo installation folder that you just need to copy and paste on your computer), and connect to the server using the HubNet client connexion interface displayed below.

Connexion with HubNet client connexion interface

Name	Activity	Server	Port
game-session-1	main	10.34.66.44	9173

- Choose the session you want to connect to (or enter manually the server address and port)
- Enter a user name
- Click on the "enter" button
- Once connected, the player waits for the game to start and then he can start playing by playing an activity card on each of his field and choosing how much he wants to contribute to the water harvesting public infrastructure. (for instance the interface of player 1 (Bruno Client) in Figure below, where player 4 just changed the activity card standing on his first plot).

Client game interface

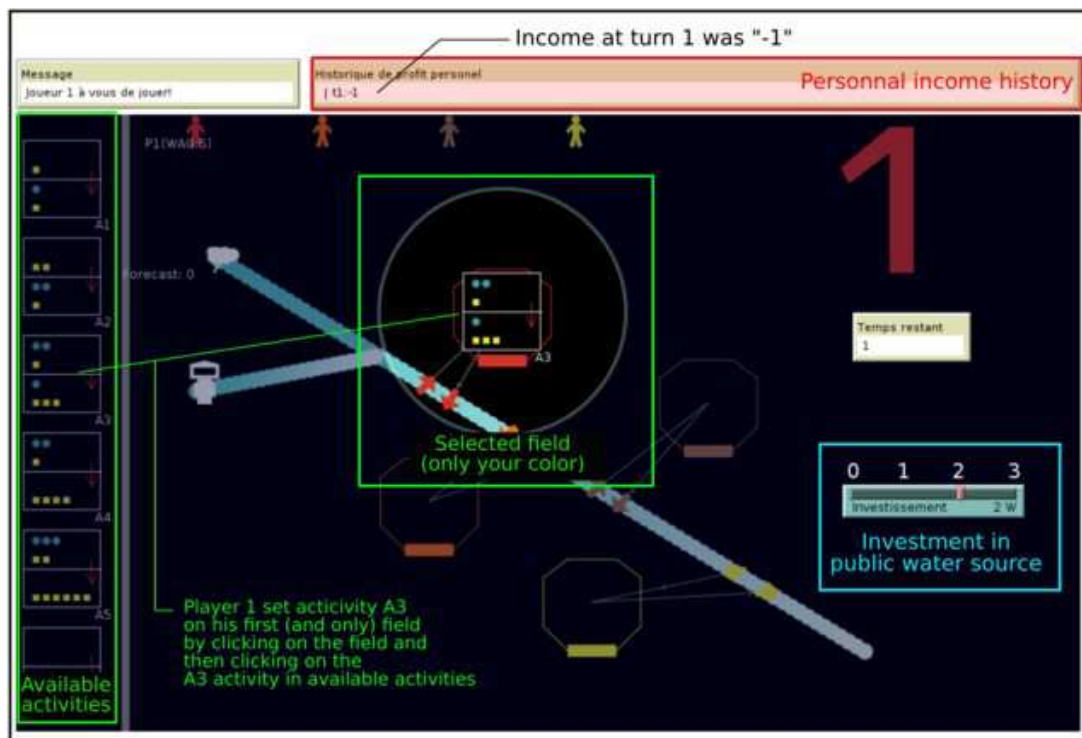

- Select your investment in public water source (here player 1 chooses 2) - for each one of your fields (fields of your color) set the activity by clicking on the field (it becomes highlighted with a white halo) and then clicking on the activity you want to settle.
- You can see how much time is remaining for the current round (here 1 second).
- You can see your income for previous rounds (here only one previous round t1, where your income was "-1").
- You can see your actual wealth under the figure representing you in the top of the screen (here the red player owns 5 WAGs).

Simulate (Experimenter): Run simulations with computerized players

The experimenter can test his watersheds models by running simulations where human players are replaced by computer agents. An inference engine has been built to model agents' behaviours but at the moment given rules are very simple so agent behaviour is erratic. However it enables to watch a simulation when you do not want to play all the players (see Figure below).

Simulation interface

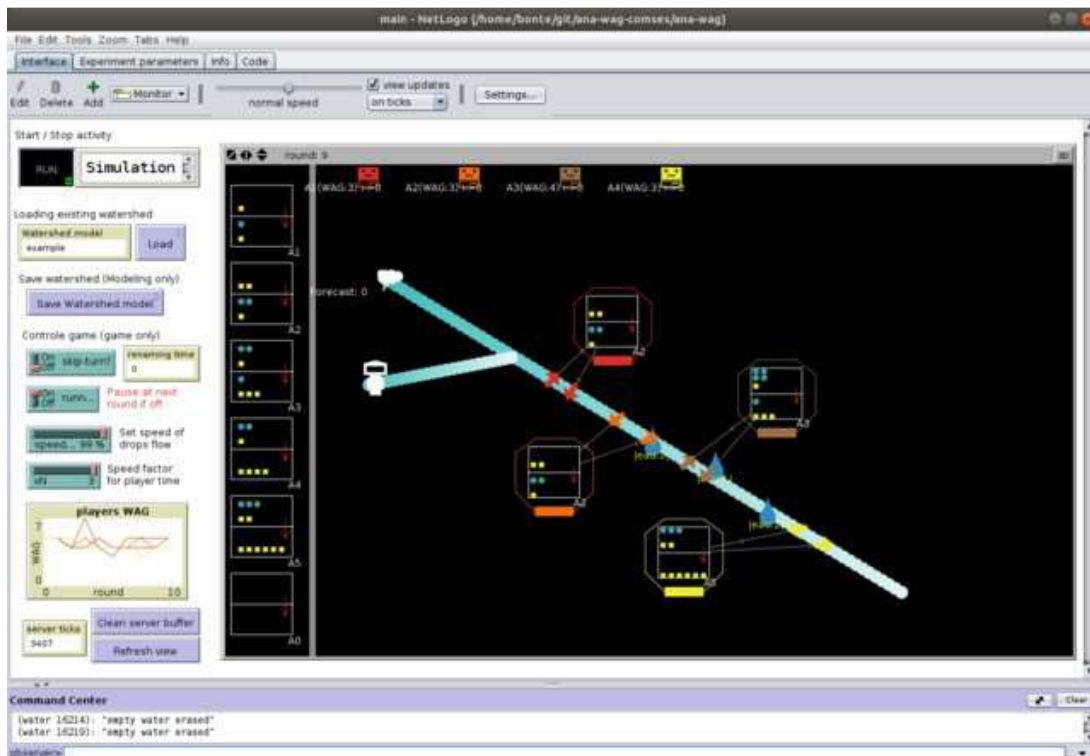

- Just click on RUN button and the simulation starts.
- At beginning the game is on pause. If you want to start it, you need to click set the start/pause switch **On**.
- Rounds are passed automatically and activities and investments are chosen automatically by each agents (you can see on the image that drops of water are flowing in the watershed).

Download and Installation of AnaWAG

All software used are free of charge and open-source (Platform: NetLogo 5.3.1, Programming Language: NetLogo, Operating System: Platform Independent, Model code licensed Under: GNU GPL, Version 3). In order to use AnaWAG you must first: - firstly download and install NetLogo 5.3.1 (NetLogo download page), - And then secondly download the extra-widget extension v1.1.0 (ExtraWidget extension page) and install it as an extension in your NetLogo installation as explained in the extension guide of NetLogo (just put the downloaded file in the righth folder of your NetLogo install).

Details and implementation in NetLogo

Mapping of the WAG model in the NetLogo world

The conceptual model of AnaWAG presented above as "the conceptual class diagram" has been mapped to the NetLogo meta-model in order to implement the model in the NetLogo platform (See Figure below).

Mapping of the WAG conceptual model used in AnaWAG into the NetLogo meta-model

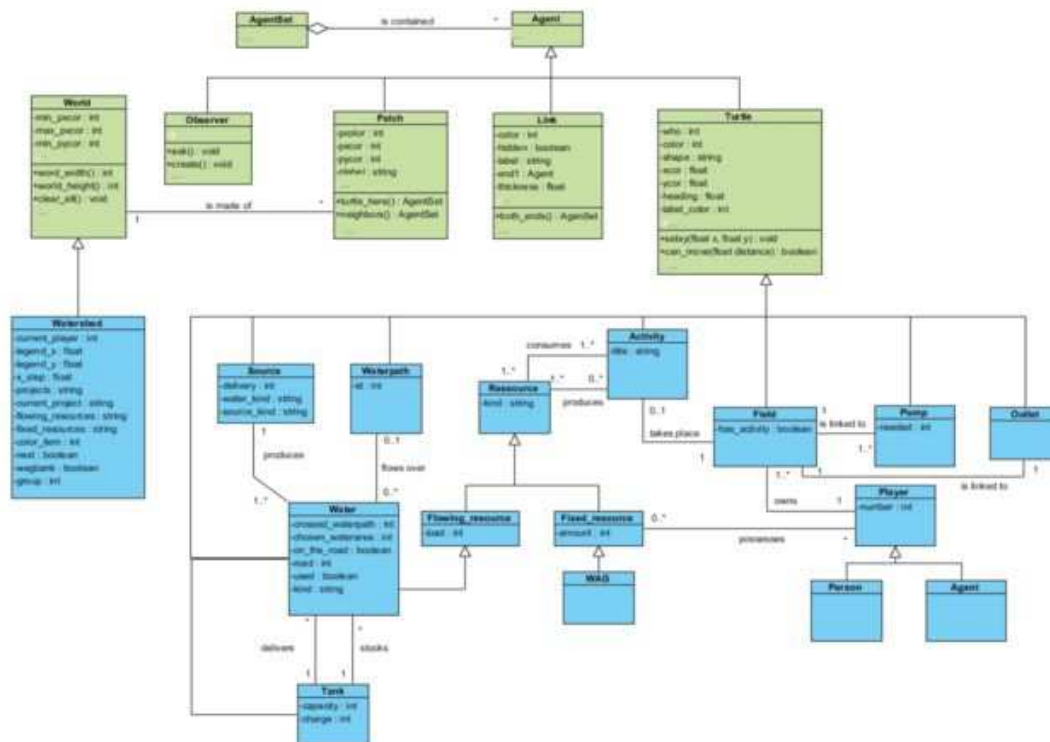

Process overview and scheduling of the WAG model

In the AnaWAG device, the simulation corresponds to the network game feature or to a simulation with computer agents. When it is a network game, it is managed by a specific user of the device called the experimenter that starts each round when all players are ready. Once the round is started, the Players (or agents) choose the activities they want to install on each of their fields, as well as the investment they want to put in the artificial source of water. Then the Waterpath entities distribute water through each Field and the Activities entities determine if they succeed (get enough resources) or not. An UML sequence diagram presents the scheduling in the WAG model used in AnaWAG in Figure below.

Sequence diagram of the WAG model used in AnaWAG

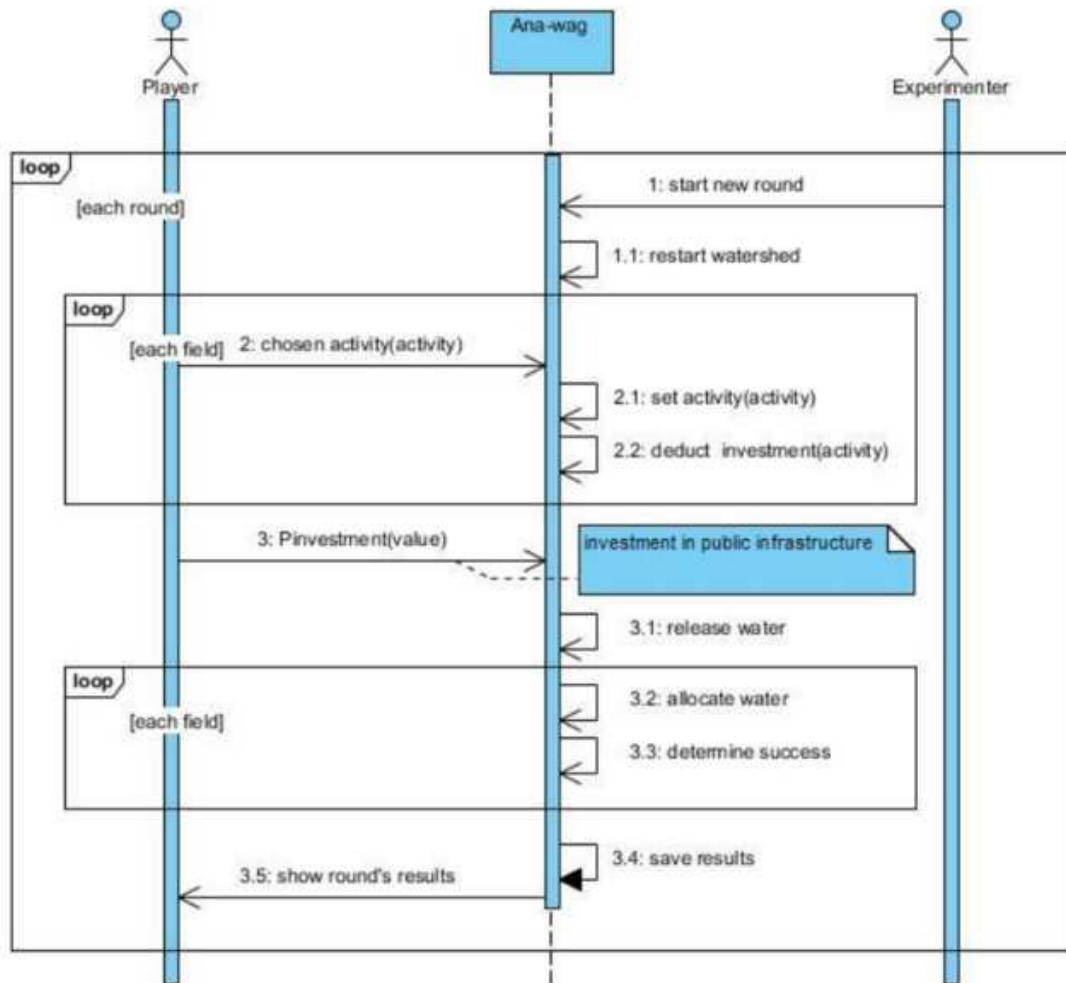

Development and results analysis

Analysis of simulation or game session can be automatized with R software. A script is provided in the analysis folder of the source code.

Computer code is split in a main source file called *main.nlogo* (in the root of the *ana-wag* folder) and a specific file for each class of the model (*class-mame.nls*) situated in the *src* folder.

watershed folder is used to store watershed models. raw results files are saged in the *results* folder.

Sets of rules describing agents behaviors are saved in *AgentRulesDatabase* folder.

database folder is not used yet.

Instructions

The experience you are about to participate in is intended for the study of decision-making. We ask you to read the instructions carefully, they should allow you to fully understand the experience. When all participants have read these instructions, an experimenter will read them aloud. All your decisions will be treated anonymously. You will indicate your choices to the computer you are sitting in front of. From now on, we ask you to stop talking. If you have a question, raise your hand and an experimenter will come and answer you in private.

During the experiment you will accumulate earnings, expressed in experimental currency units, the WAG. At the end of the experiment your accumulated earnings will be converted into euros at the conversion rate: 1 WAG = 1 euro.

General framework

You are one of four members of a group of farmers in an irrigated system who share a borehole to irrigate their fields. The amount of water produced by the borehole depends on the maintenance provided by the group: the more the group contributes to the maintenance, the more water the borehole will produce.

The fields of the four farmers are aligned along an irrigation channel, water arrives first in the fields of the first, then in the second, etc. Your position (1, 2, 3 or 4) will be indicated at the beginning of the game and will remain unchanged until the end of the game.

You will be able to use the water from the canal to carry out your activities. These activities are represented by "activity cards" that you can install on your field. The activities have a cost (1 to 2 WAGs depending on the activities) and generate revenue (1 to 6 WAGs) as explained in the glossary.

The game is repeated 15 times. You will have 5 training rounds beforehand which will not count in your remuneration.

Water availability

There are two sources of water: surface water (rain) and groundwater from drilling.

- By default one unit of surface water comes from the rain every turn.
- The amount of water produced by drilling each tower depends on the amount of money invested by the group each tower in its maintenance. Figure 1 shows the number of units of produced water (on the ordinate) as a function of the total contribution invested by the group (on the abscissa).

Outline of a turn

A turn lasts 30 seconds. You will have a countdown at the top right of the screen. Each turn you can invest up to 5 WAGs: 0 to 3 WAGs in drilling maintenance (action 1) and 0 to 2 WAGs in an "activity card" (action 2).

Action 1: To invest in drilling maintenance you must position the cursor under the corresponding number (see image 1).

Action 2: your field is highlighted and you can choose the activity you want to perform by clicking on one of the cards in the left column (see image 1).

At the end of the tour, the water (rain + drilling + possibly water produced by the activities) flows from the upstream (top left) to the downstream (bottom right) and is gradually distributed in the fields.

Gain for each turn

Your gain is determined by the income generated by the chosen activity minus the investment in drilling maintenance and the cost of the activity card.

Example:

You contribute up to 1 WAG to the maintenance of the borehole and choose map 4. This requires two water units and an investment of 1 WAG and in return it generates an income of 4 WAGs.

- If at least two units of water reach the field, your gain is 4 (income) - 1 (activity cost) - 1 (drilling investment) = 2 WAGs.

- If, on the other hand, less than two units of water reach the field, your gain is 0 (income) - 1 (activity cost) - 1 (drilling investment) = -2 WAGs.

Figure 1: Drilling water production based on the group's contribution

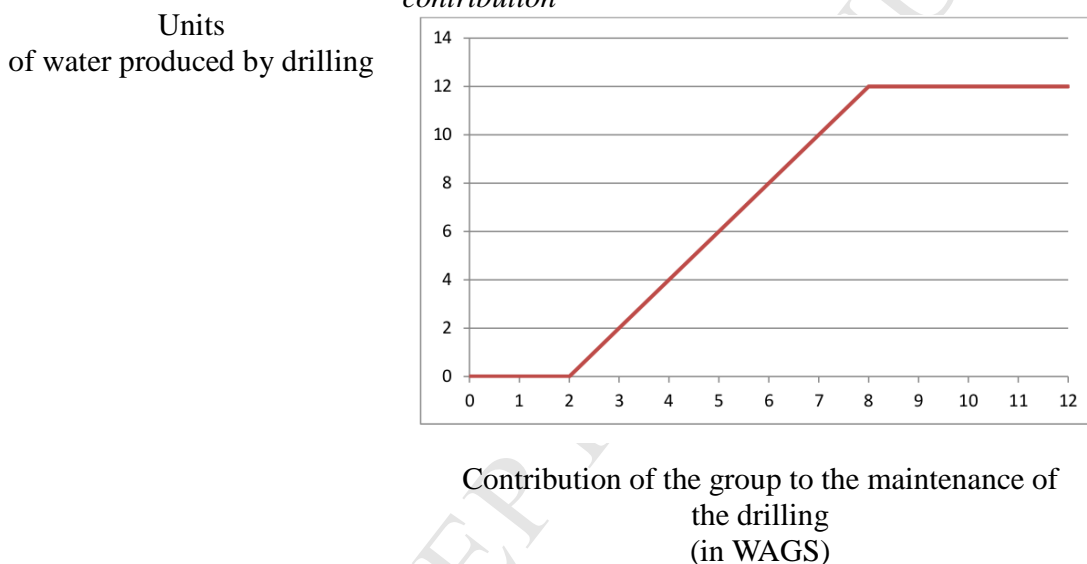

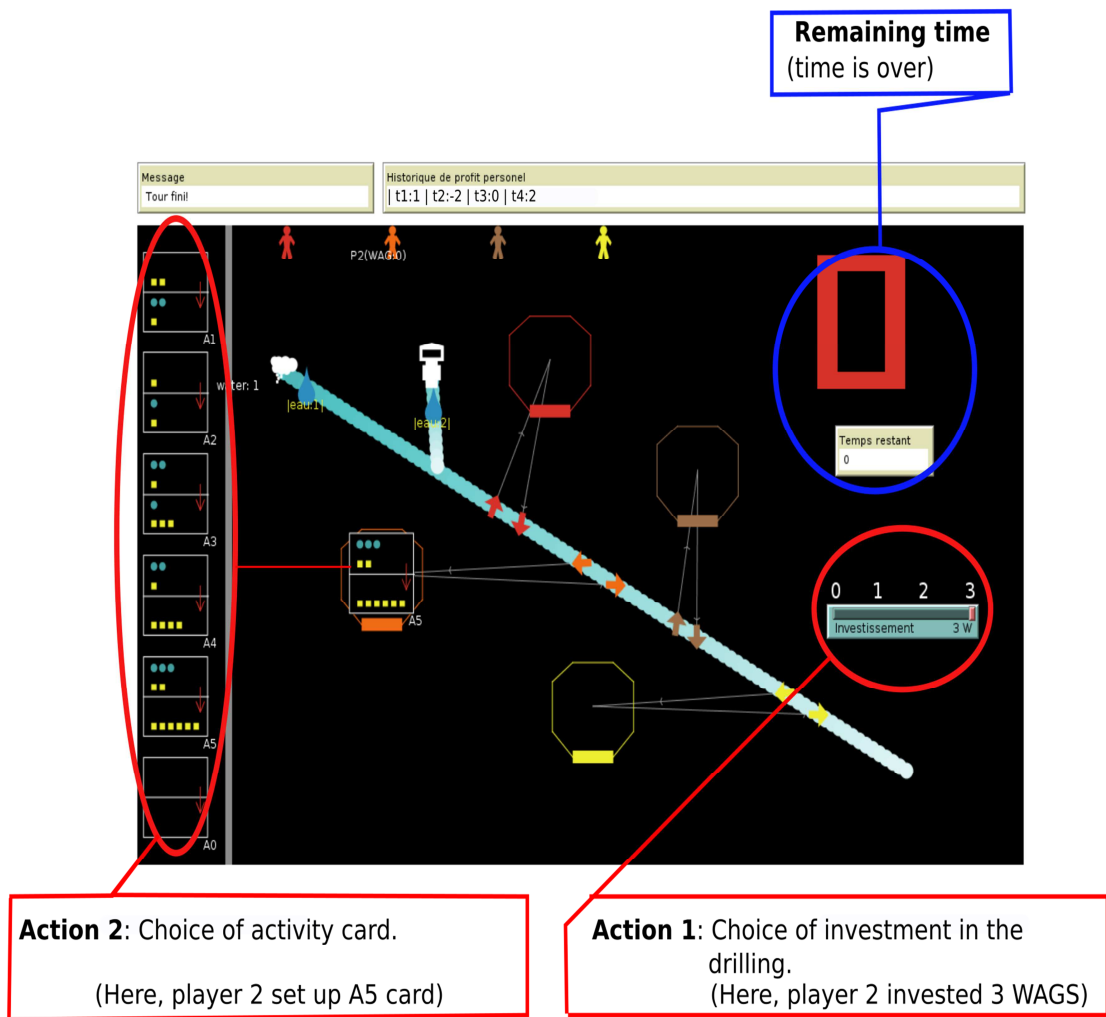
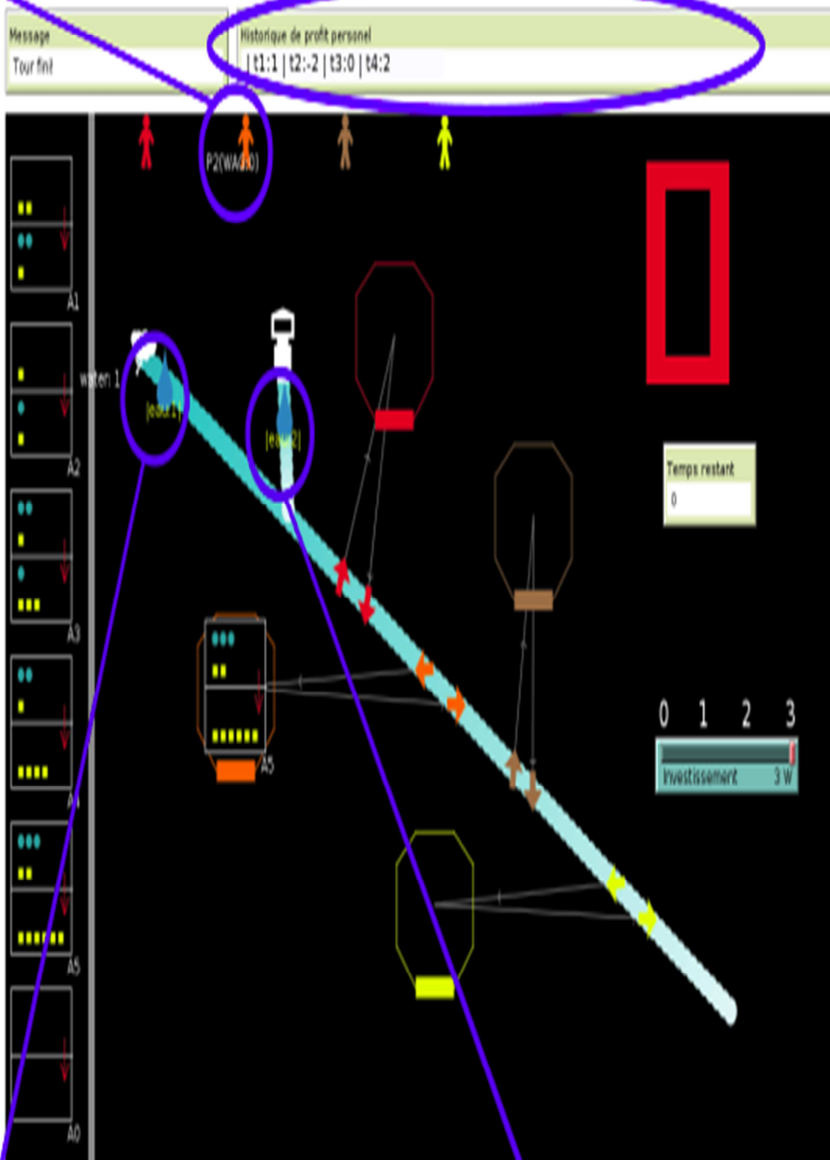

Image 1 : Interface – Actions

Image 2 : Interface – Informations

Info 1: Number and color of player
(Player 2 used his 5 WAGs for this turn, he invested 2 WAGs in the activity 3 in the drilling)

Info 2: history of player's payoff
(player 2 had a payoff of 1 at time 1 of -2 at time 2, of 0 at time 3, etc.)



Info 3: Units of water from rain
(here, one units arrives from the rain)

Info 4: Units of water from the drilling
(here, two units comes from the drilling)

GLOSSAIRE

**Field:**

The position of your land in the irrigated system is represented by an exaggeration of your color.

**Water:**

Water is represented by drops each representing one or more units of water (here a unit of water). In the activity maps, the water needs and the water discharged is symbolized by blue dots (●).

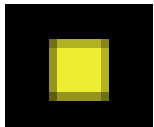
**WAG:**

WAGs are represented in the activity cards by yellow squares. They represent your economic resource. Your actions in the game will cause you to win or lose WAGs each game turn.

**Drilling:**

Produces water from the borehole.

**Rain:**

Produces natural surface water.

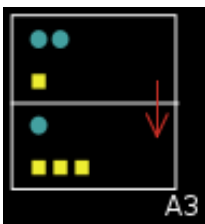
The activity cards :

There are 5 different activity cards that you can make on your field. The activity requires a number of WAGs (■) and water units (●) to be realized (upper part of the map). It rejects a certain amount in return and, if it receives all the water it needs, it is successful and produces money (lower part of the map). Once the activity is placed, the number of WAGs necessary for its realization will be deducted from your profit of the corresponding round. If the activity is successful, the money it produces will be less expensive and your contribution to the drilling will be less of a benefit to you.

Example: If a player wants to play the A3 card (above) he must invest 1 WAGs. If it receives two units of water, the activity is successful and the player who installed it will receive 3 WAGs. In addition, a unit of water received by the field will be returned to the irrigated system. Imagine that the player has invested 1 WAG in the maintenance of the borehole and the activity is successful, his profit for this round will be 1 WAG (2 WAGs invested and 3 WAGs won).

Highlights

- A conceptual framework to design reflexive studies on the modelling of Social and Ecological Systems
- Based on a new kind of meta-modelling and experimental economics
- An experimental design that instantiates the conceptual framework
- An associated software system implemented and tested (implemented in the NetLogo agent based modelling and simulation platform)