



Re-submittal Form

Case Name/ Number: _____

Case Manager: _____

Re-submitted Items:

- Development Plan/ Site Plan
- Plat
- Parking/ Landscape Plan
- Engineering Documents
- Subdivision Improvements Agreement
- Other: _____

*** All re-submittals must have this cover sheet and a cover letter addressing review comments.**

Please note the re-submittal review period is 21 days.

The cover letter must include the following information:

- Restate each comment that requires a response
- Provide a response below the comment with a description of the revisions
- Identify any additional changes made to the original document

For County Use Only:

Date Accepted:

Staff (accepting intake):

Resubmittal Active: Engineering; Planner; ~~Right-of-Way; Addressing; Building Safety;~~

~~Neighborhood Services; Environmental; Parks;~~ Attorney; Finance; Plan Coordination



April 30, 2024

Greg Barnes
Principal Planner
Adams County Community and Economic Development
4430 South Adams County Parkway, 1st Floor, Suite W2000A
Brighton, CO 80601

**RE: CLEAR CREEK TRANSIT VILLAGE – FINAL DEVELOPMENT PLAN AND
FINAL PLAT RESUBMITTALS**

Dear Mr. Barnes,

Thank you for taking the time to review the Final Development Plan and Plat for the Clear Creek Transit Village project. We appreciate the feedback and are looking forward to moving to the Planning Commission and the Board of County Commissioners. Please refer to the following pages for our responses to comments made. Should you have any questions or concerns please feel free to reach out to me by phone, at 303-892-1166 or by email, bmahar@norris-design.com.

Sincerely,
Norris Design

A handwritten signature in black ink that reads "Bill Mahar".

Bill Mahar, AICP
Principal



COMMENTING DIVISION: PLANNER REVIEW

NAME OF REVIEWER: GREG BARNES

PLN01: FYI – The subdivision engineering review must be approved by Staff prior to this case being scheduled for public hearings.

Response: Comment noted.

PLN02: ACTION NEEDED – The subdivision improvements agreement must be resubmitted for review. There are still outstanding comments for the last round of review, and I do not believe it was resubmitted back to us.

Response: The SIA has been included with the resubmittal.

COMMENTING DIVISION: ATTORNEY REVIEW

NAME OF REVIEWER: CHRISTINE FINCH

Comment: Attorney Redlines sent to Developer’s attorney on 4/25. Please ensure that the SIA is submitted to the County’s system with the next submittal.

Response: The SIA has been included with the resubmittal.

COMMENTING DIVISION: DEVELOPMENT ENGINEERING REVIEW

NAME OF REVIEWER: MATTHEW EMMENS

ENG10: The SIA that was submitted for review is lacking the required exhibits. Revise the SIA to include those exhibits.

Response: The updated SIA has been included and contains exhibits.

ENG11: The Tract dedication statements on the Final Plat for Tracts A, I, J, K, and M should contain the following language: “This/These tracts are to be preserved for water quality purposes, no construction activities re allowed in this/these.”

Response: Information has been added to sheet 6 within the plat.

-End of response to comments-

**CLEAR CREEK TRANSIT VILLAGE
*** FINAL PLAT *****

PRC2023-00011

A PORTION OF THE WEST HALF (W 1/2) OF SECTION 8, TOWNSHIP 3 SOUTH, RANGE 68 WEST
OF THE SIXTH PRINCIPAL MERIDIAN, COUNTY OF ADAMS, STATE OF COLORADO
SHEET 1 OF 14

CERTIFICATE OF DEDICATION AND OWNERSHIP

KNOW ALL MEN BY THESE PRESENTS, THAT THE UNDERSIGNED, CLEAR CREEK DEVELOPMENT, LLC, A DELAWARE LIMITED LIABILITY COMPANY, BEING THE OWNER OF THE LAND DESCRIBED AND CONVEYED IN THAT CERTAIN SPECIAL WARRANTY DEED RECORDED JUNE 23, 2020 AT RECEPTION No. 2020000056492, AS SHOWN IN THIS PRELIMINARY PLAT AND DESCRIBED AS FOLLOWS:

LOT 2, BLOCK 1, BRANNAN'S SUBDIVISION FILING NO. 2, ACCORDING TO THE PLAT RECORDED MAY 12, 1994 AT RECEPTION NO/ B1247454, AND AS AMENDED BY AFFIDAVIT OF CORRECTION RECORDED JANUARY 19, 1995 IN BOOK 4455 AT PAGE 542, EXCEPT THAT PART CONVEYED TO THE COUNTY OF ADAMS BY WARRANTY DEED MADE A PART OF RESOLUTION RECORDED MAY 25, 1995 IN BOOK 4518 AT PAGE 777, COUNTY OF ADAMS, STATE OF COLORADO.

TOGETHER WITH TRACT A, BRANNAN'S SUBDIVISION - FILING NO. 1, ACCORDING TO THE PLAT RECORDED OCTOBER 31, 1973 AT RECEPTION NO. A020815, COUNTY OF ADAMS, STATE OF COLORADO.

THE ABOVE DESCRIBED SUBJECT PROPERTY IS ALSO DESCRIBED AS FOLLOWS:

A PORTION OF THE WEST HALF (W 1/2) OF SECTION 8, TOWNSHIP 3 SOUTH, RANGE 68 WEST OF THE 6TH PRINCIPAL MERIDIAN, COUNTY OF ADAMS, STATE OF COLORADO, DESCRIBED AS FOLLOWS:

COMMENCING AT THE NORTHEAST CORNER OF THE NORTHWEST QUARTER (NW 1/4) OF SAID SECTION 8, FROM WHENCE THE SOUTHEAST CORNER OF SAID NORTHWEST QUARTER (NW 1/4) BEARS SOUTH 00°00'36" WEST A DISTANCE OF 2635.75 FEET, WITH ALL BEARINGS HEREIN RELATED THERETO; THENCE ALONG THE EAST LINE OF SAID NORTHWEST QUARTER (NW 1/4), SOUTH 00°00'36" WEST, 1977.44 FEET TO A POINT; THENCE LEAVING SAID EAST LINE, NORTH 89°45'17" WEST, 50.00 FEET TO THE WEST LINE OF FEDERAL BOULEVARD, AND BEING THE NORTHEAST CORNER OF TRACT A OF BRANNAN'S SUBDIVISION FILING No. 1, AND BEING THE POINT OF BEGINNING;

THENCE ALONG SAID WEST LINE, SOUTH 00°00'36" WEST, 658.53 FEET TO A POINT; THENCE LEAVING SAID WEST LINE, SOUTH 89°51'23" WEST, 30.00 FEET TO A POINT; THENCE SOUTH 00°00'04" WEST, 31.23 FEET TO A POINT; THENCE SOUTH 83°46'03" WEST, 233.62 FEET TO A POINT; THENCE SOUTH 61°35'26" WEST, 404.96 FEET TO A POINT ON THE BOUNDARY OF LOT 2 OF BRANNAN'S SUBDIVISION FILING No. 2; THENCE ALONG SAID BOUNDARY THE FOLLOWING FOUR (4) COURSES:

1. SOUTH 03°44'30" WEST, 159.68 FEET TO A POINT;
2. NORTH 85°27'01" WEST, 446.37 FEET TO A POINT;
3. NORTH 03°30'34" EAST, 1038.07 FEET TO A POINT;
4. SOUTH 89°45'17" EAST, 1010.39 FEET TO THE POINT OF BEGINNING.

CONTAINING ±918,826 SQUARE FEET OR ±21.093 ACRES OF LAND, MORE OR LESS.

HAS BY THESE PRESENTS LAID OUT, PLATTED, AND SUBDIVIDED THE SAME INTO LOTS, BLOCKS, TRACTS, EASEMENTS AND STREETS AS SHOWN ON THIS PLAT UNDER THE NAME AND STYLE OF CLEAR CREEK TRANSIT VILLAGE, AND DOES HEREBY DEDICATE ALL PUBLIC STREETS TO ADAMS COUNTY FOR PUBLIC USE. THE UNDERSIGNED DOES HEREBY DEDICATE, GRANT AND CONVEY TO ADAMS COUNTY, THOSE PUBLIC EASEMENTS AS SHOWN ON THE PLAT; AND FURTHER RESTRICTS THE USE OF ALL PUBLIC EASEMENTS TO ADAMS COUNTY AND/OR ITS ASSIGNS, PROVIDED HOWEVER, THAT THE SOLE RIGHT AND AUTHORITY TO RELEASE OR QUITCLAIM ALL OR ANY SUCH PUBLIC EASEMENTS SHALL REMAIN EXCLUSIVELY VESTED IN ADAMS COUNTY.

FOR: CLEAR CREEK DEVELOPMENT, LLC, A DELAWARE LIMITED LIABILITY COMPANY;
BY: THISTLE CREEK QOF I, L.P., A DELAWARE LIMITED PARTNERSHIP, ITS MANAGING MEMBER;
BY: THISTLE CREEK QOF I GP, LLC, A DELAWARE LIMITED LIABILITY COMPANY, ITS GENERAL PARTNER

EXECUTED THIS ____ DAY OF _____, 20 ____.

BY: MICHAEL CHRISTENSEN, MANAGER

NOTARY ACKNOWLEDGMENT

STATE OF _____)
) SS.
COUNTY OF _____)

THE FOREGOING CERTIFICATE OF DEDICATION AND OWNERSHIP WAS ACKNOWLEDGED BEFORE ME THIS ____ DAY OF _____, 20____, BY MICHAEL CHRISTENSEN, MANAGER OF THISTLE CREEK QOF I GP, LLC, A DELAWARE LIMITED LIABILITY COMPANY, GENERAL PARTNER OF THISTLE CREEK QOF I, L.P., A DELAWARE LIMITED PARTNERSHIP, MANAGING MEMBER OF CLEAR CREEK DEVELOPMENT, LLC, A DELAWARE LIMITED LIABILITY COMPANY.

WITNESS MY HAND AND SEAL:

NOTARY PUBLIC MY COMMISSION EXPIRES
ADDRESS OF NOTARY: _____



VICINITY MAP
Not to scale

TABLE OF CONTENTS	
1	COVER SHEET
2	COVER SHEET NOTES
3	EXISTING CONDITIONS
4	PROPOSED CONDITIONS
5	ADDRESS MAP
6	LAND USE TABLES
7-14	FINAL PLAT

ADAMS COUNTY ATTORNEY'S OFFICE

APPROVED AS TO FORM

BOARD OF COUNTY COMMISSIONERS APPROVAL

APPROVED BY THE ADAMS COUNTY BOARD OF COMMISSIONERS THIS ____ DAY OF _____, A.D. 202__.

CHAIR

SURVEYOR'S CERTIFICATE

I, RICHARD B. GABRIEL, A LICENSED PROFESSIONAL LAND SURVEYOR IN THE STATE OF COLORADO, DO HEREBY CERTIFY THAT THIS LAND SURVEY PLAT CORRECTLY REPRESENTS THE RESULTS OF A SURVEY MADE BY ME OR UNDER MY DIRECT SUPERVISION ON OCTOBER 11, 2019, THAT THE MONUMENTS SHOWN HEREON ARE OF THE CHARACTER SHOWN AND OCCUPY THE POSITIONS INDICATED AND THAT ALL NOTES, DIMENSIONS AND IMPROVEMENTS ARE CORRECTLY SHOWN HEREIN TO THE BEST OF MY KNOWLEDGE AND BELIEF.

RICHARD B. GABRIEL, P.L.S.
Colorado License No. 37929
For and on behalf of
Power Surveying Company, Inc.

CLERK AND RECORDER

THIS FINAL PLAT WAS FILED FOR RECORD IN THE OFFICE OF THE ADAMS COUNTY CLERK AND RECORDER IN THE STATE OF COLORADO, AT ____ M. ON THIS ____, DAY OF _____, A.D. 202__.

DEPUTY CLERK AND RECORDER RECEPTION NUMBER

HOLDER OF DEED OF TRUST CERTIFICATE

THE UNDERSIGNED, AS LEGAL HOLDER OF THE DEED OF TRUST RECORDED ON SEPTEMBER 22, 2022 AT RECEPTION NUMBER 2022000079140, OF THE RECORDS OF THE ADAMS COUNTY COLORADO CLERK & RECORDER, HEREBY CONSENTS TO THE WITHIN PLAT.

SIGNED THIS ____ DAY OF _____, 202__.

FOR: MSH CAPITAL, LLC, A UTAH LIMITED LIABILITY COMPANY

BY: _____

TITLE: _____

NOTARY PUBLIC

STATE OF _____)
) SS.
COUNTY OF _____)

THE FOREGOING INSTRUMENT WAS ACKNOWLEDGED BEFORE ME THIS ____ DAY OF _____, 20____, BY _____ AS _____ OF MSH CAPITAL, LLC, A UTAH LIMITED LIABILITY COMPANY.

WITNESS MY HAND AND SEAL:

NOTARY PUBLIC MY COMMISSION EXPIRES
ADDRESS OF NOTARY: _____

STATEMENT OF PURPOSE

THIS FINAL PLAT WAS PREPARED AND RECORDED TO CREATE 145 PRIVATE LOTS, TRACTS FOR ACCESS AND DRAINAGE FACILITIES AND TO DEDICATE PUBLIC RIGHT-OF-WAY.

COVER SHEET
FINAL PLAT

	TYPE OF SUBMITTAL:	FINAL PLAT
	PREPARATION DATE:	JANUARY 31, 2023
	REVISION DATE:	JULY 12, 2023
	REVISION DATE:	OCTOBER 24, 2023
	REVISION DATE:	JANUARY 19, 2024
JOB NO. 19-260	DWG: 19-260 FINAL.dwg	
SHEET 1 OF 14		

CLEAR CREEK TRANSIT VILLAGE

*** FINAL PLAT ***

PRC2023-00011

A PORTION OF THE WEST HALF (W 1/2) OF SECTION 8, TOWNSHIP 3 SOUTH, RANGE 68 WEST
OF THE SIXTH PRINCIPAL MERIDIAN, COUNTY OF ADAMS, STATE OF COLORADO

SHEET 2 OF 14

STORM DRAINAGE FACILITIES STATEMENT

THE POLICY OF THE COUNTY REQUIRES THAT MAINTENANCE ACCESS SHALL BE PROVIDED TO ALL STORM DRAINAGE FACILITIES TO ASSURE CONTINUOUS OPERATIONAL CAPABILITY OF THE SYSTEM. THE PROPERTY OWNERS SHALL BE RESPONSIBLE FOR THE MAINTENANCE OF ALL DRAINAGE FACILITIES INCLUDING INLETS, PIPES, CULVERTS, CHANNELS, DITCHES, HYDRAULIC STRUCTURES, AND DETENTION BASINS LOCATED ON THEIR LAND UNLESS MODIFIED BY THE SUBDIVISION DEVELOPMENT AGREEMENT. TRACTS THAT WILL CONTAIN STORM DRAINAGE AND WATER QUALITY INFRASTRUCTURE WILL BE OWNED AND MAINTAINED BY THE CLEAR CREEK TRANSIT METROPOLITAN DISTRICT NO. 1. SHOULD THE OWNER FAIL TO MAINTAIN SAID FACILITIES, THE COUNTY SHALL HAVE THE RIGHT TO ENTER SAID LAND FOR THE SOLE PURPOSE OF OPERATIONS AND MAINTENANCE. ALL SUCH MAINTENANCE COST WILL BE ASSESSED TO THE PROPERTY OWNERS.

TRACT MAINTENANCE NOTE

BY THIS PLAT INGRESS, EGRESS AND REGRESS FOR TRACT C IS LIMITED TO FEDERAL BOULEVARD AS SHOWN ON SHEETS 4, 5, 9 AND 12 OF 16 AND ACCESS IS APPROVED BY CDOT AND ADAMS COUNTY, COLORADO AND WILL BE OWNED AND MAINTAINED BY CLEAR CREEK TRANSIT METROPOLITAN DISTRICT NO. 1.

TRACT A IS CREATED FOR LANDSCAPE AND WILL BE OWNED BY THE CLEAR CREEK DEVELOPMENT LLC AND MAINTAINED BY GRANTEE.

TRACTS B AND D ARE CREATED FOR LANDSCAPE AND WILL BE OWNED AND MAINTAINED BY THE HOMEOWNERS' ASSOCIATION.

TRACTS E, F, G AND H ARE CREATED FOR PEDESTRIAN, ACCESS AND UTILITIES AND WILL BE OWNED AND MAINTAINED BY THE CLEAR CREEK TRANSIT METROPOLITAN DISTRICT NO. 1.

TRACT I AND J ARE CREATED FOR OPEN SPACE AND WILL BE OWNED AND MAINTAINED BY THE CLEAR CREEK TRANSIT METROPOLITAN DISTRICT NO. 1.

TRACT K AND M ARE CREATED FOR LANDSCAPE WILL BE OWNED AND MAINTAINED BY THE CLEAR CREEK TRANSIT METROPOLITAN DISTRICT NO. 1.

TRACT L IS CREATED FOR FUTURE ACCESS TO THE ADJACENT PROPERTY AND WILL BE OWNED AND MAINTAINED BY CLEAR CREEK TRANSIT METROPOLITAN DISTRICT NO. 1.

ADAMS COUNTY ASSUMES NO RESPONSIBILITY OR LIABILITY REGARDING STREETS, CDOT ACCESS, PRIVATE DRIVES, AND SIDEWALKS, AND WILL NOT PERFORM MAINTENANCE OPERATIONS INCLUDING SNOW REMOVAL.

UTILITY EASEMENT NOTES

- ALL TRACTS ARE HEREBY DEDICATED FOR UTILITY USE.
- UTILITY EASEMENTS ARE DEDICATED TO ADAMS COUNTY FOR THE BENEFIT OF THE APPLICABLE UTILITY PROVIDERS FOR THE INSTALLATION, MAINTENANCE, AND REPLACEMENT OF ELECTRIC, GAS, TELEVISION, CABLE, AND TELECOMMUNICATIONS FACILITIES (DRY UTILITIES). UTILITY EASEMENTS SHALL ALSO BE GRANTED WITHIN ANY ACCESS EASEMENTS AND PUBLIC STREETS IN THE SUBDIVISION. PERMANENT STRUCTURES, IMPROVEMENTS, OBJECTS, BUILDINGS, WELLS, AND OTHER OBJECTS THAT MAY INTERFERE WITH THE UTILITY FACILITIES OR USE THEREOF (INTERFERING OBJECTS) SHALL NOT BE PERMITTED WITHIN SAID UTILITY EASEMENTS AND THE UTILITY PROVIDERS, AS GRANTEES, MAY REMOVE ANY INTERFERING OBJECTS AT NO COST TO SUCH GRANTEES, INCLUDING, WITHOUT LIMITATION, VEGETATION. PUBLIC SERVICE COMPANY OF COLORADO (PSCO) AND ITS SUCCESSORS RESERVE THE RIGHT TO REQUIRE ADDITIONAL EASEMENTS AND TO REQUIRE THE PROPERTY OWNER TO GRANT PSCO AN EASEMENT ON ITS STANDARD FORM.
- FIVE-FOOT (5') WIDE UTILITY EASEMENTS ARE HEREBY DEDICATED ON PRIVATE PROPERTY ADJACENT TO THE FRONT LOT LINES AND SIDE LOT LINES AS SHOWN HEREON. IN ADDITION, TEN-FOOT (10') WIDE DRY UTILITY EASEMENTS ARE HEREBY DEDICATED ALONG THE EAST LOT LINES OF BLOCKS 1 AND BLOCK 2. THESE EASEMENTS ARE DEDICATED TO ADAMS COUNTY FOR THE BENEFIT OF THE APPLICABLE UTILITY PROVIDERS FOR THE INSTALLATION, MAINTENANCE, AND REPLACEMENT OF UTILITIES. UTILITY EASEMENTS SHALL ALSO BE GRANTED WITHIN ANY ACCESS EASEMENTS AND PRIVATE STREETS IN THE SUBDIVISION. PERMANENT STRUCTURES, IMPROVEMENTS, OBJECTS, BUILDINGS, WELLS, WATER METERS AND OTHER OBJECTS THAT MAY INTERFERE WITH THE UTILITY FACILITIES OR USE THEREOF (INTERFERING OBJECTS) SHALL NOT BE PERMITTED WITHIN SAID UTILITY EASEMENTS AND THE UTILITY PROVIDERS, AS GRANTEES, MAY REMOVE ANY INTERFERING OBJECTS AT NO COST TO SUCH GRANTEES, INCLUDING, WITHOUT LIMITATION, VEGETATION.

BASIS OF BEARINGS

BEARINGS ARE BASED UPON THE EAST LINE OF THE NORTHWEST QUARTER OF SECTION 8, TOWNSHIP 3 SOUTH, RANGE 68 WEST OF THE SIXTH PRINCIPAL MERIDIAN ASSUMED TO BEAR SOUTH 00°00'36" WEST A DISTANCE OF 2,635.75 FEET, AS DEFINED AND MEASURED BETWEEN A FOUND 3-1/4" DIAMETER ALUMINUM CAP STAMPED "PLS 26288 COLO DEPT OF TRANSPORTATION" IN A RANGE BOX AT THE NORTH 1/4 CORNER SAID SECTION 8 AND THE CENTER 1/4 SAID SECTION 8 BY A FOUND 3-1/4" DIAMETER ALUMINUM CAP STAMPED "PLS 23519 CHARLES H RUSSELL ADAMS COUNTY" IN A RANGE BOX, AS SHOWN HEREON.

SURVEYOR'S NOTES

- ACCORDING TO COLORADO LAW YOU MUST COMMENCE ANY LEGAL ACTION BASED UPON ANY DEFECT IN THIS SURVEY WITHIN THREE YEARS AFTER YOU FIRST DISCOVER SUCH DEFECT. IN NO EVENT, MAY ANY ACTION BASED UPON ANY DEFECT IN THIS SURVEY BE COMMENCED MORE THAN TEN YEARS FROM THE DATE OF THE CERTIFICATION SHOWN HEREON.
- ANY PERSON WHO KNOWINGLY REMOVES, ALTERS, OR DEFACTS ANY PUBLIC LAND SURVEY MONUMENT OR LAND BOUNDARY MONUMENT OR ACCESSORY, COMMITS A CLASS TWO (2) MISDEMEANOR PURSUANT TO STATE STATUTE 18-4-508, CRS.
- THIS SURVEY DOES NOT CONSTITUTE A TITLE SEARCH BY POWER SURVEYING COMPANY INC. TO DETERMINE OWNERSHIP OR EASEMENTS OF RECORD, RIGHT-OF-WAY, AND TITLE OF RECORD. POWER SURVEYING COMPANY INC. RELIED UPON OLD REPUBLIC NATIONAL TITLE INSURANCE COMPANY'S ORDER NO. ABC70787447.1, EFFECTIVE DATE OF MARCH 6, 2023 AT 5:00 P.M. FOR THIS INFORMATION.
- FLOOD ZONE DESIGNATION: AS SHOWN ON F.I.R.M. MAP PANEL #08001C0592H, WITH AN EFFECTIVE REVISION DATE OF MARCH 5, 2007, THE SUBJECT PROPERTY LIES WITHIN ZONE "X" (AREAS DETERMINED TO BE OUTSIDE THE 0.2% ANNUAL CHANCE FLOODPLAIN) AND WITHIN ZONE "AE" (SPECIAL FLOOD HAZARD AREA SUBJECT TO INUNDATION BY THE 1% PERCENT ANNUAL CHANCE FLOOD - BASE FLOOD ELEVATIONS DETERMINED). REFER TO MAP SHEETS FOR APPROXIMATE LOCATIONS OF FLOOD ZONE BOUNDARIES.
- FIELD SURVEY COMPLETION DATE: OCTOBER 11, 2019.
- THE LINEAR UNIT OF MEASUREMENT FOR THIS FINAL PLAT IS THE INTERNATIONAL FOOT, DEFINED AS EXACTLY 0.3048 METER.
- STATEMENT RESTRICTING ACCESS: INGRESS, EGRESS, AND REGRESS ARE LIMITED TO FEDERAL BLVD. UNLESS APPROVED BY CDOT AND ADAMS COUNTY, COLORADO.
- PROPERTY ADDRESS: 6001 FEDERAL BLVD, DENVER, CO 80221.
- THE SUBJECT PROPERTY CONTAINS ±918,827 SQUARE FEET OR ±21.093 ACRES OF LAND.

COVER SHEET - NOTES
FINAL PLAT

 6911 BROADWAY DENVER, COLORADO 80221 Established 1988 PH: 303-702-1517 FAX: 303-702-1488 WWW.POWERSURVEYING.COM	TYPE OF SUBMITTAL:	FINAL PLAT
	PREPARATION DATE:	JANUARY 31, 2023
	REVISION DATE:	JULY 12, 2023
	REVISION DATE:	OCTOBER 24, 2023
	REVISION DATE:	JANUARY 19, 2024
	JOB NO. 19-260	DWG: 19-260 FINAL.dwg

SHEET 2 OF 14

CLEAR CREEK TRANSIT VILLAGE

*** FINAL PLAT ***

PRC2023-00011

A PORTION OF THE WEST HALF (W 1/2) OF SECTION 8, TOWNSHIP 3 SOUTH, RANGE 68 WEST
OF THE SIXTH PRINCIPAL MERIDIAN, COUNTY OF ADAMS, STATE OF COLORADO

SHEET 3 OF 14

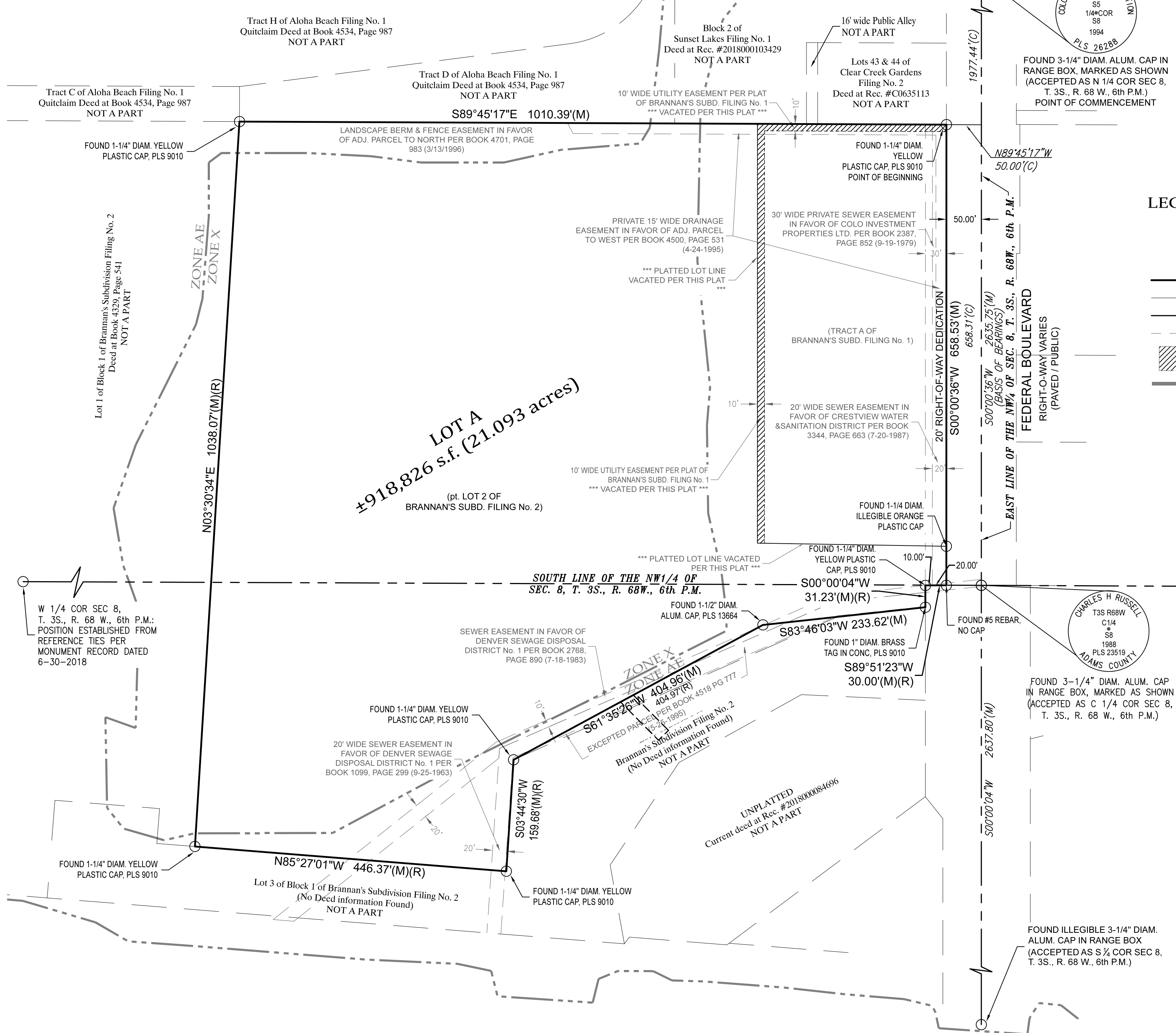

LEGEND OF SYMBOLS & ABBREVIATIONS

- SET REBAR & 1-1/2" DIAMETER YELLOW PLASTIC CAP, PLS 37929, TYPICAL UNLESS NOTED OTHERWISE
- MONUMENT FOUND, AS NOTED
- PLAT BOUNDARY LIMITS
- ADJOINING PARCEL OR LOT LINE
- PUBLIC LANDS SURVEY SECTION LINE
- EXISTING RECORD EASEMENT LINE
- EXISTING EASEMENT VACATED PER THIS PLAT
- F.I.R.M. ZONE LINE DESIGNATION
- DIAM** DIAMETER
- (C)** CALCULATED DIMENSION
- (M)** MEASURED DIMENSION
- (R)** RECORD DIMENSION

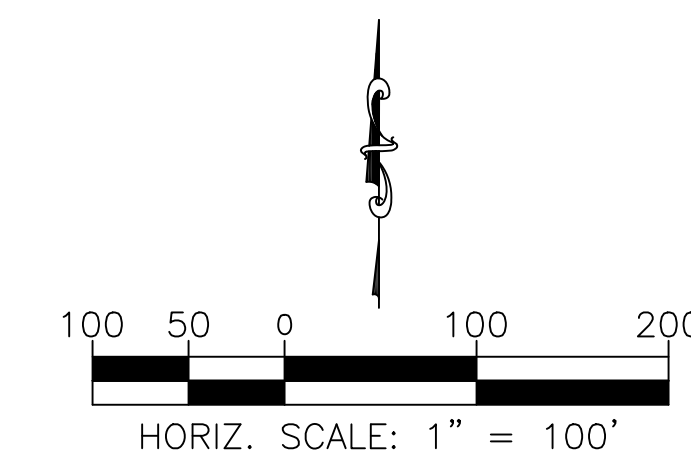
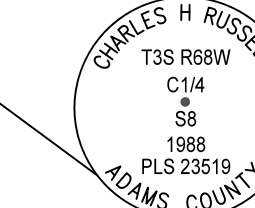
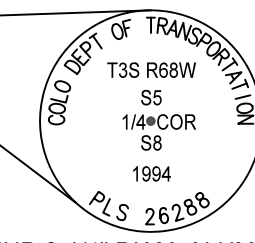

BOUNDARY ANALYSIS, EXISTING CONDITIONS
FINAL PLAT

	TYPE OF SUBMITTAL:	FINAL PLAT
	PREPARATION DATE:	JANUARY 31, 2023
	REVISION DATE:	JULY 12, 2023
	REVISION DATE:	OCTOBER 24, 2023
	REVISION DATE:	JANUARY 19, 2024
JOB NO. 19-260	DWG: 19-260 FINAL.dwg	
SHEET 3 OF 14		

CLEAR CREEK TRANSIT VILLAGE

*** FINAL PLAT ***

A PORTION OF THE WEST HALF (W 1/2) OF SECTION 8, TOWNSHIP 3 SOUTH, RANGE 68 WEST OF THE SIXTH PRINCIPAL MERIDIAN, COUNTY OF ADAMS, STATE OF COLORADO

SHEET 4 OF 14

PRC2023-00011

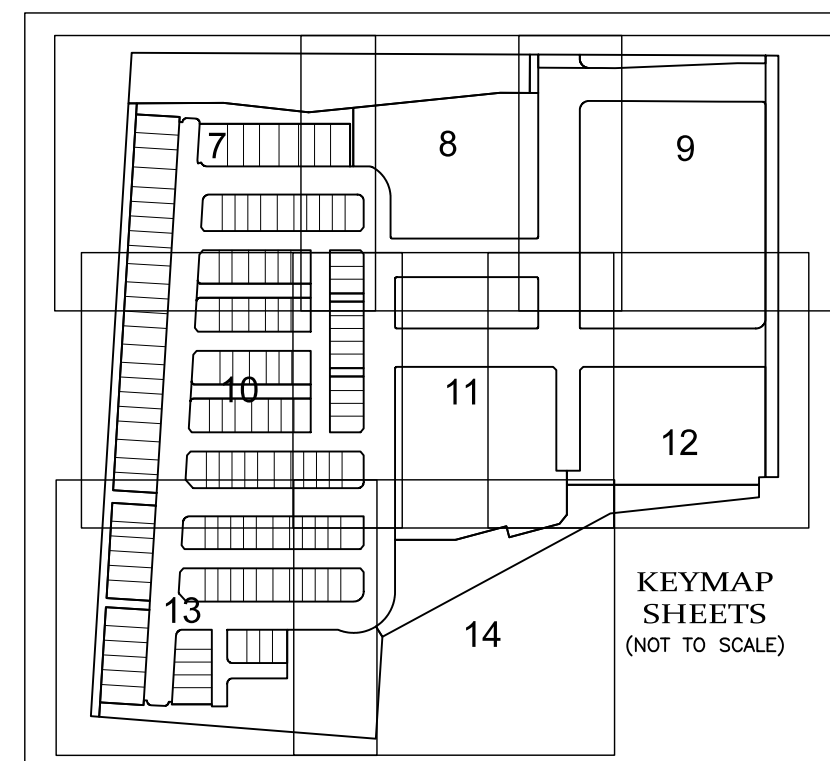
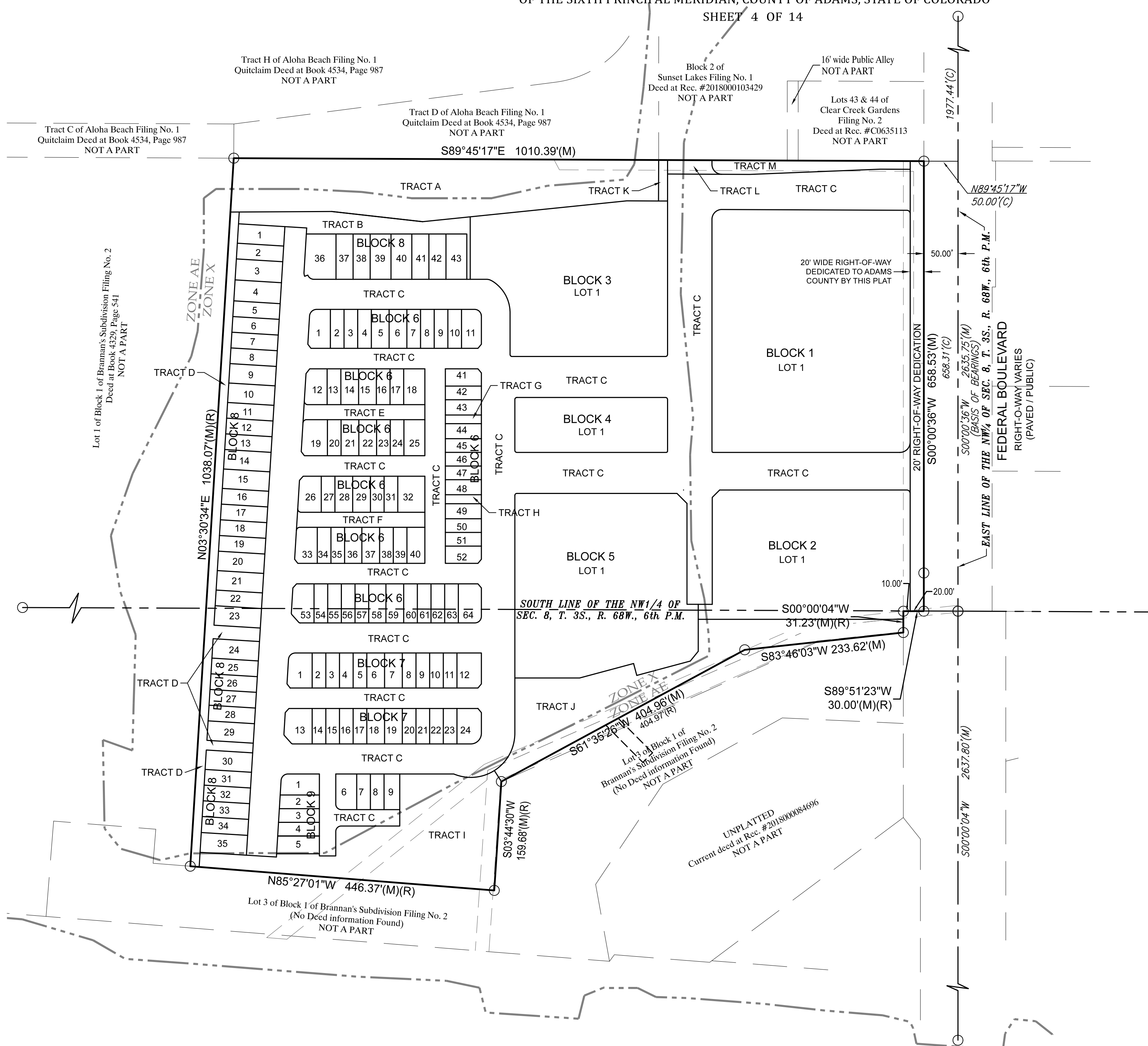

LEGEND OF SYMBOLS & ABBREVIATIONS

- SET REBAR & 1-1/2" DIAMETER YELLOW PLASTIC CAP, PLS 37929, TYPICAL UNLESS NOTED OTHERWISE
- MONUMENT FOUND, AS NOTED
- DIAM DIAMETER
- (C) CALCULATED
- (M) MEASURED
- (R) RECORD
- U.E. UTILITY EASEMENT
- BLOCK # LOT OR BLOCK NUMBER
- PUBLIC LANDS SURVEY SECTION LINE
- PLAT BOUNDARY LIMITS
- NEW LOT & TRACT LINE PER THIS PLAT
- PROPOSED EASEMENT
- EXISTING RECORD EASEMENT LINE
- ADJOINING PARCEL OR LOT LINE
- F.E.M.A. FLOOD BOUNDARY (AS NOTED)

FOR ADAMS COUNTY ROAD DEDICATION AND TRACTS B, D AND E DETAILS, SEE SHEET 15.

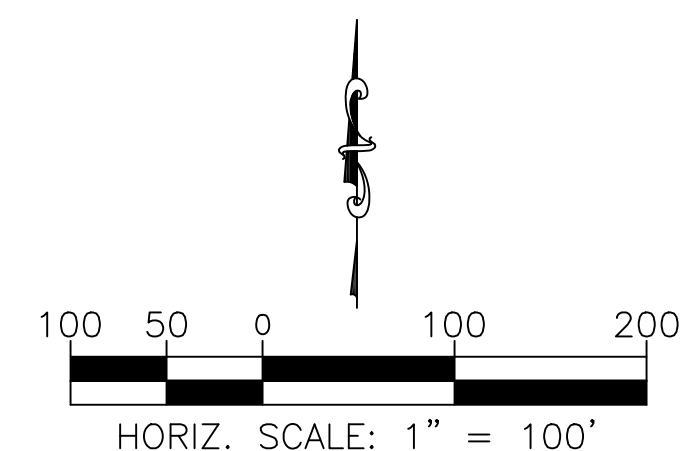

PROPOSED CONDITIONS
FINAL PLAT

<p>POWER Surveying Company, Inc. Established 1988 6911 BROADWAY DENVER, COLORADO 80221 PH: 303-752-9517 FAX: 303-752-1488 WWW.POWER-SURVEYING.COM</p>	TYPE OF SUBMITTAL:	FINAL PLAT
	PREPARATION DATE:	JANUARY 31, 2023
	REVISION DATE:	JULY 12, 2023
	REVISION DATE:	OCTOBER 24, 2023
	REVISION DATE:	JANUARY 19, 2024
JOB NO. 19-260	DWG: 19-260 FINAL.dwg	

CLEAR CREEK TRANSIT VILLAGE

*** FINAL PLAT ***

A PORTION OF THE WEST HALF (W 1/2) OF SECTION 8, TOWNSHIP 3 SOUTH, RANGE 68 WEST
OF THE SIXTH PRINCIPAL MERIDIAN, COUNTY OF ADAMS, STATE OF COLORADO

SHEET 5 OF 14

PRC2023-00011

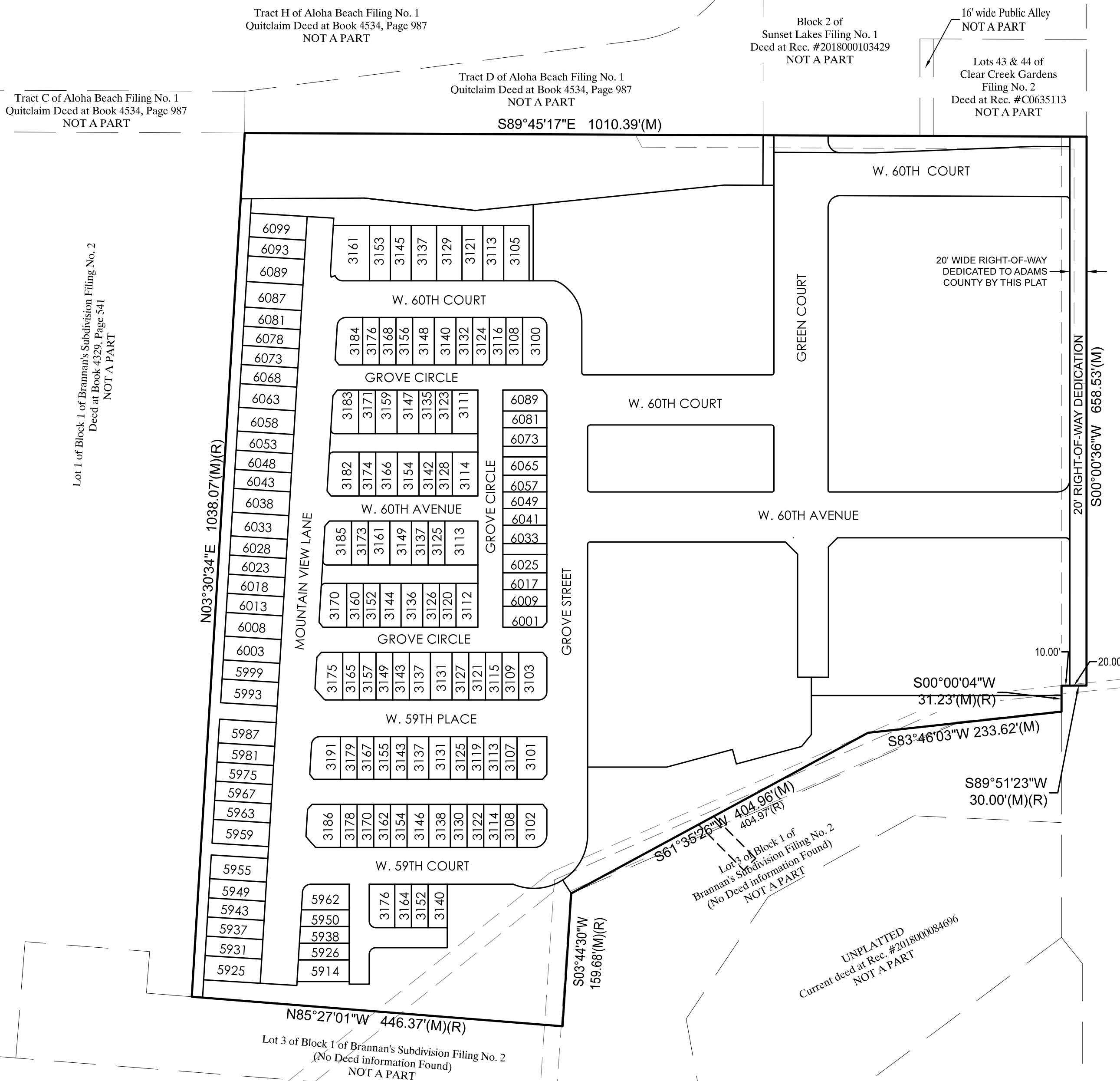
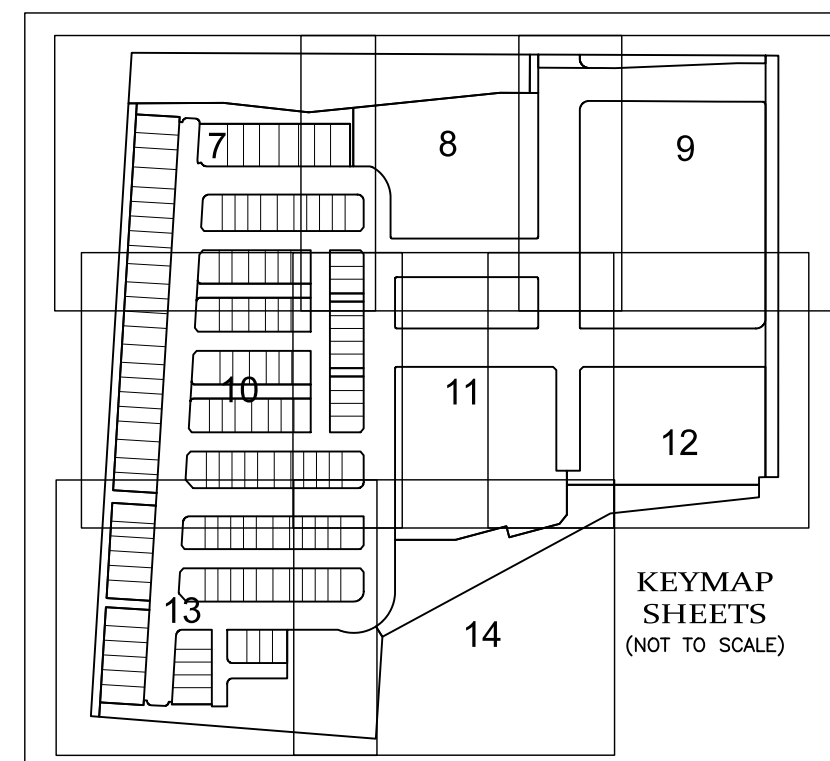

- ### LEGEND OF SYMBOLS & ABBREVIATIONS
- SET REBAR & 1-1/2" DIAMETER YELLOW PLASTIC CAP, PLS 37929, TYPICAL UNLESS NOTED OTHERWISE
 - MONUMENT FOUND, AS NOTED
 - DIAM DIAMETER
 - (C) CALCULATED
 - (M) MEASURED
 - (R) RECORD
 - U.E. UTILITY EASEMENT
 - BLOCK # LOT OR BLOCK NUMBER
 - PUBLIC LANDS SURVEY SECTION LINE
 - PLAT BOUNDARY LIMITS
 - NEW LOT & TRACT LINE PER THIS PLAT
 - PROPOSED EASEMENT
 - EXISTING RECORD EASEMENT LINE
 - ADJOINING PARCEL OR LOT LINE
 - F.E.M.A. FLOOD BOUNDARY (AS NOTED)
- FOR ADAMS COUNTY ROAD DEDICATION AND TRACTS B, D AND E DETAILS, SEE SHEET 15.

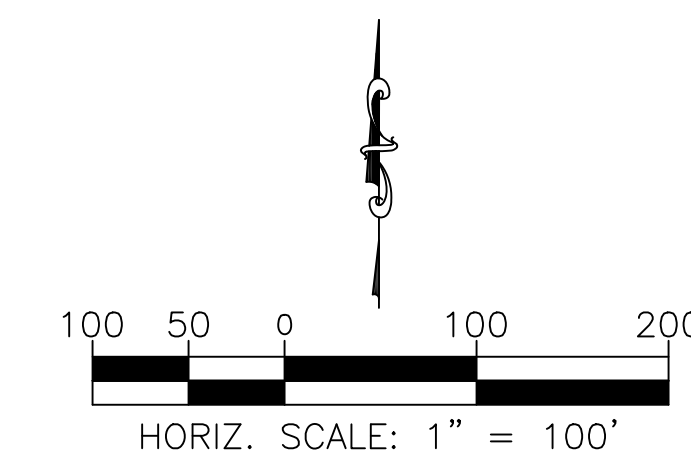

ADDRESS MAP
FINAL PLAT

<p>POWER Surveying Company, Inc. Established 1988 PH: 303-702-1517 FAX: 303-702-1488 WWW.POWER-SURVEYING.COM</p>	TYPE OF SUBMITTAL:	FINAL PLAT
	PREPARATION DATE:	JANUARY 31, 2023
	REVISION DATE:	JULY 12, 2023
	REVISION DATE:	OCTOBER 24, 2023
	REVISION DATE:	JANUARY 19, 2024
JOB NO. 19-260	DWG: 19-260 FINAL.dwg	

CLEAR CREEK TRANSIT VILLAGE

*** FINAL PLAT ***

PRC2023-00011

A PORTION OF THE WEST HALF (W 1/2) OF SECTION 8, TOWNSHIP 3 SOUTH, RANGE 68 WEST
OF THE SIXTH PRINCIPAL MERIDIAN, COUNTY OF ADAMS, STATE OF COLORADO

SHEET 6 OF 14

BLOCK / LOT DATA

BLOCK NO.	±SQ. FT.	±ACRES
BLOCK 1	102,894	2.362
BLOCK 2	55,092	1.265
BLOCK 3	56,950	1.307
BLOCK 4	17,955	0.412
BLOCK 5	67,356	1.546
BLOCK 6	81,987	1.882
BLOCK 7	29,247	0.671
BLOCK 8	76,021	1.745
BLOCK 9	11,744	0.270
TOTAL AREA	499,247	11.461

BLOCK 6		
LOT NO.	±SQ. FT.	±ACRES
LOT 1	1,768	0.041
LOT 2	1,140	0.026
LOT 3	1,140	0.026
LOT 4	1,140	0.026
LOT 5	1,482	0.034
LOT 6	1,482	0.034
LOT 7	1,140	0.026
LOT 8	1,140	0.026
LOT 9	1,140	0.026
LOT 10	1,140	0.026
LOT 11	1,620	0.037
LOT 12	1,661	0.038
LOT 13	1,048	0.024
LOT 14	1,363	0.031
LOT 15	1,363	0.031
LOT 16	1,048	0.024
LOT 17	1,048	0.024
LOT 18	1,628	0.037
LOT 19	1,936	0.044
LOT 20	1,056	0.024
LOT 21	1,372	0.032
LOT 22	1,372	0.032
LOT 23	1,056	0.024
LOT 24	1,056	0.024
LOT 25	1,620	0.037
LOT 26	1,726	0.040
LOT 27	1,054	0.024
LOT 28	1,369	0.031
LOT 29	1,372	0.031
LOT 30	1,054	0.024
LOT 31	1,054	0.024
LOT 32	2,093	0.048
LOT 33	1,621	0.037
LOT 34	1,054	0.024
LOT 35	1,054	0.024
LOT 36	1,370	0.031
LOT 37	1,370	0.031
LOT 38	1,054	0.024
LOT 39	1,054	0.024
LOT 40	1,385	0.032
LOT 41	1,316	0.030
LOT 42	1,054	0.024
LOT 43	1,178	0.027
LOT 44	1,160	0.027
LOT 45	1,054	0.024
LOT 46	1,054	0.024
LOT 47	1,054	0.024
LOT 48	1,160	0.027
LOT 49	1,160	0.027
LOT 50	1,054	0.024
LOT 51	1,054	0.024
LOT 52	1,316	0.030
LOT 53	1,711	0.039
LOT 54	1,144	0.026
LOT 55	1,144	0.026
LOT 56	1,144	0.026
LOT 57	1,144	0.026
LOT 58	1,487	0.034
LOT 59	1,487	0.034
LOT 60	1,144	0.026
LOT 61	1,144	0.026
LOT 62	1,144	0.026
LOT 63	1,144	0.026
LOT 64	1,893	0.043
TOTAL AREA	81,987	1.882

BLOCK 7		
LOT NO.	±SQ. FT.	±ACRES
LOT 1	1,790	0.041
LOT 2	1,024	0.024
LOT 3	1,024	0.024
LOT 4	1,024	0.024
LOT 5	1,024	0.024
LOT 6	1,331	0.031
LOT 7	1,331	0.031
LOT 8	1,024	0.024
LOT 9	1,024	0.024
LOT 10	1,024	0.024
LOT 11	1,024	0.024
LOT 12	1,813	0.042
LOT 13	2,009	0.046
LOT 14	1,037	0.024
LOT 15	1,037	0.024
LOT 16	1,037	0.024
LOT 17	1,037	0.024
LOT 18	1,348	0.031
LOT 19	1,348	0.031
LOT 20	1,037	0.024
LOT 21	1,037	0.024
LOT 22	1,037	0.024
LOT 23	1,037	0.024
LOT 24	1,785	0.041
TOTAL AREA	29,247	0.671

BLOCK 8		
LOT NO.	±SQ. FT.	±ACRES
LOT 1	1,938	0.044
LOT 2	1,564	0.036
LOT 3	2,090	0.048
LOT 4	2,090	0.048
LOT 5	1,564	0.036
LOT 6	1,564	0.036
LOT 7	1,564	0.036
LOT 8	1,564	0.036
LOT 9	1,938	0.044
LOT 10	1,938	0.044
LOT 11	1,564	0.036
LOT 12	1,564	0.036
LOT 13	1,564	0.036
LOT 14	1,938	0.044
LOT 15	1,938	0.044
LOT 16	1,564	0.036
LOT 17	1,564	0.036
LOT 18	1,564	0.036
LOT 19	1,564	0.036
LOT 20	1,938	0.044
LOT 21	1,938	0.044
LOT 22	1,564	0.036
LOT 23	1,938	0.044
LOT 24	1,938	0.044
LOT 25	1,564	0.036
LOT 26	1,564	0.036
LOT 27	1,564	0.036
LOT 28	1,564	0.036
LOT 29	1,938	0.044
LOT 30	1,938	0.044
LOT 31	1,564	0.036
LOT 32	1,564	0.036
LOT 33	1,564	0.036
LOT 34	1,598	0.037
LOT 35	1,972	0.045
LOT 36	2,966	0.068
LOT 37	1,659	0.038
LOT 38	1,659	0.038
LOT 39	2,024	0.046
LOT 40	2,024	0.046
LOT 41	1,659	0.038
LOT 42	1,659	0.038
LOT 43	2,024	0.046
TOTAL AREA	76,021	1.745

BLOCK 9		
LOT NO.	±SQ. FT.	±ACRES
LOT 1	1,714	0.039
LOT 2	1,159	0.027
LOT 3	1,184	0.027
LOT 4	1,208	0.028
LOT 5	1,607	0.037
LOT 6	1,587	0.036
LOT 7	1,043	0.024
LOT 8	1,043	0.024
LOT 9	1,199	0.028
TOTAL AREA	11,744	0.270

LAND USE TABLE

	± SQ. FT.	± ACRES
BLOCKS	499,247	11.461
TRACTS	406,408	9.330
DEDICATION	13,172	0.302
SITE TOTAL	918,827	21.093
TRACT & DEDICATION TOTAL	420,883	9.662

TRACT & DEDICATION DATA

TRACTS & DEDICATION				
TRACT	±SQ. FT.	±ACRES	LAND USE	OWNERSHIP
TRACT A	48,131	1.105	LANDSCAPE & UTILITY, WATER QUALITY PRESERVATION	CLEAR CREEK DEVELOPMENT, LLC
TRACT B	8,453	0.194	LANDSCAPE, UTILITIES & DRAINAGE	HOMEOWNERS' ASSOCIATION
TRACT C	249,336	5.724	METRO DISTRICT ROADS FOR PUBLIC ACCESS	CLEAR CREEK TRANSIT METROPOLITAN DISTRICT NO. 1
TRACT D	14,763	0.339	LANDSCAPE, UTILITIES & DRAINAGE	HOMEOWNERS' ASSOCIATION
TRACT E	3,915	0.09	ACCESS & UTILITIES	CLEAR CREEK TRANSIT METROPOLITAN DISTRICT NO. 1
TRACT F	4,127	0.095	ACCESS & UTILITIES	CLEAR CREEK TRANSIT METROPOLITAN DISTRICT NO. 1
TRACT G	666	0.015	ACCESS & UTILITIES	CLEAR CREEK TRANSIT METROPOLITAN DISTRICT NO. 1
TRACT H	692	0.016	ACCESS & UTILITIES	CLEAR CREEK TRANSIT METROPOLITAN DISTRICT NO. 1
TRACT I	36,223	0.831	UTILITIES, ACCESS, DRAINAGE & LANDSCAPE, WATER QUALITY PRESERVATION	CLEAR CREEK TRANSIT METROPOLITAN DISTRICT NO. 1
TRACT J	33,209	0.762	UTILITIES, ACCESS, DRAINAGE & LANDSCAPE, WATER QUALITY PRESERVATION	CLEAR CREEK TRANSIT METROPOLITAN DISTRICT NO. 1
TRACT K	786	0.018	LANDSCAPE & UTILITY, WATER QUALITY PRESERVATION	CLEAR CREEK TRANSIT METROPOLITAN DISTRICT NO. 1
TRACT L	1,378	0.032	FUTURE ACCESS	CLEAR CREEK TRANSIT METROPOLITAN DISTRICT NO. 1
TRACT M	4,727	0.109	LANDSCAPE, WATER QUALITY PRESERVATION	CLEAR CREEK TRANSIT METROPOLITAN DISTRICT NO. 1
DEDICATION	13,172	0.302	RIGHT-OF-WAY DEDICATION	ADAMS COUNTY

NOTE: TRACTS A, I, J, K AND M ARE TO BE PRESERVED FOR WATER QUALITY PURPOSES AND NO CONSTRUCTION ACTIVITIES ARE ALLOWED IN THEM.

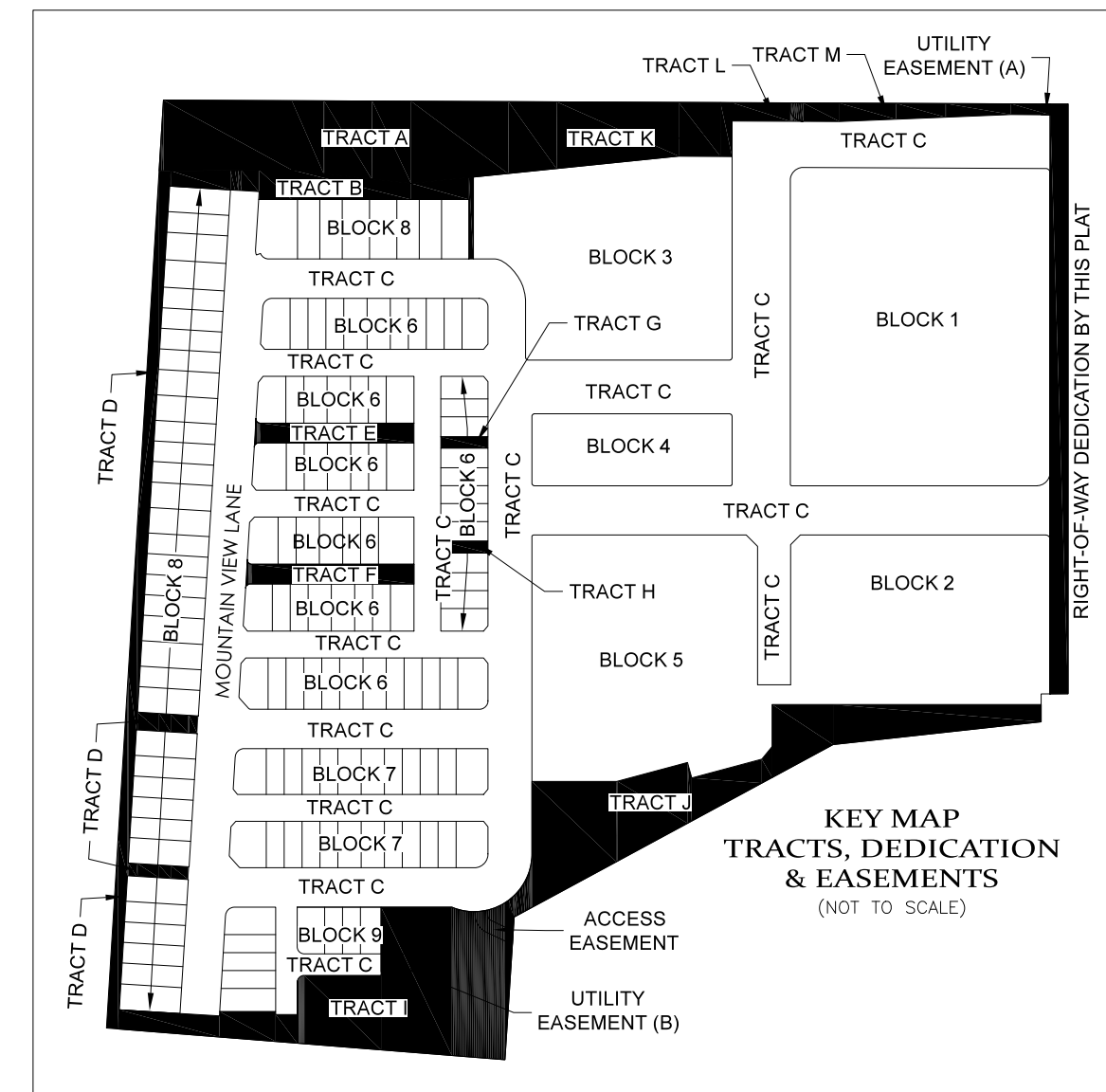

LAND USE TABLES
FINAL PLAT

<p>POWER Surveying Company, Inc. Established 1988 6911 BROADWAY DENVER, COLORADO 80221</p>	TYPE OF SUBMITTAL:	FINAL PLAT
	PREPARATION DATE:	JANUARY 31, 2023
	REVISION DATE:	JULY 12, 2023
	REVISION DATE:	OCTOBER 24, 2023
	REVISION DATE:	JANUARY 19, 2024
JOB NO. 19-260	DWG: 19-260 FINAL.dwg	

CLEAR CREEK TRANSIT VILLAGE

*** FINAL PLAT ***

A PORTION OF THE WEST HALF (W 1/2) OF SECTION 8, TOWNSHIP 3 SOUTH, RANGE 68 WEST
OF THE SIXTH PRINCIPAL MERIDIAN, COUNTY OF ADAMS, STATE OF COLORADO

SHEET 7 OF 14

PRC2023-00011

Tract C of Aloha Beach Filing No. 1
Quitclaim Deed at Book 4534, Page 987
NOT A PART

Tract D of Aloha Beach Filing No. 1
Quitclaim Deed at Book 4534, Page 987
NOT A PART

LEGEND OF SYMBOLS & ABBREVIATIONS

- SET REBAR & 1-1/2" DIAMETER YELLOW PLASTIC CAP, PLS 37929, TYPICAL UNLESS NOTED OTHERWISE
- MONUMENT FOUND, AS NOTED
- DIAM DIAMETER
- (C) CALCULATED
- (M) MEASURED
- (R) RECORD
- U.E. UTILITY EASEMENT
- BLOCK # LOT OR BLOCK NUMBER
- PUBLIC LANDS SURVEY SECTION LINE
- PLAT BOUNDARY LIMITS
- NEW LOT & TRACT LINE PER THIS PLAT
- PROPOSED EASEMENT
- EXISTING RECORD EASEMENT LINE
- ADJOINING PARCEL OR LOT LINE
- F.E.M.A. FLOOD BOUNDARY (AS NOTED)

FOR ADAMS COUNTY ROAD DEDICATION AND TRACTS B, D AND E DETAILS, SEE SHEET 15.

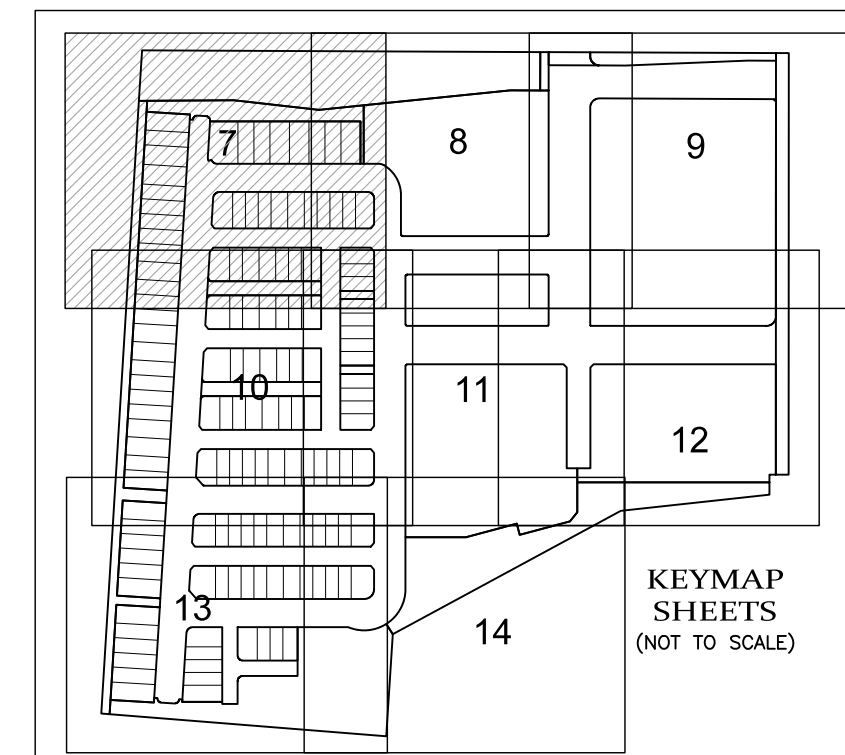

CURVE	RADIUS	ARC LENGTH	DELTA ANGLE	CHORD BEARING	CHORD LENGTH
C1	7.00'	11.00'	90°00'00"	N41°29'40"W	9.90'
C2	7.00'	11.00'	90°00'00"	N48°30'20"E	9.90'

LINE	BEARING	DISTANCE
L1	N03°30'20"E	0.79'
L2	N86°29'40"W	13.00'
L3	N86°29'40"W	5.00'
L4	N03°30'20"E	8.01'

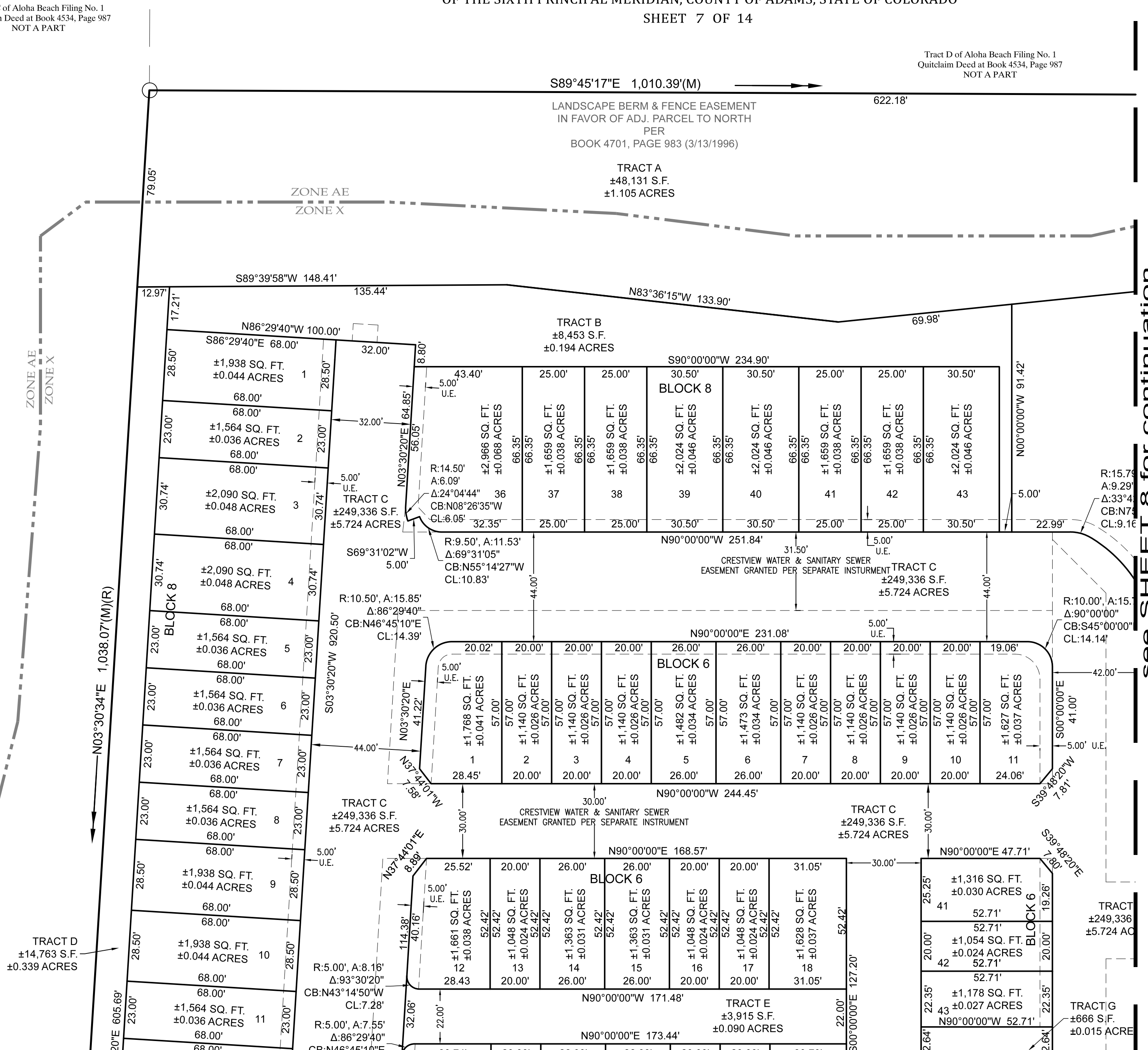
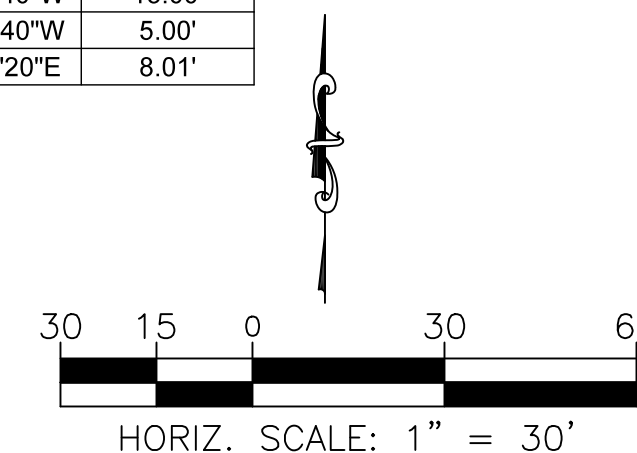

see SHEET 8 for continuation

see SHEET 10 for continuation

POWER Surveying Company, Inc.
Established 1988
6911 BRADSHAW DENVER, COLORADO 80221
PH: 303-752-9517 FAX: 303-752-1488 WWW.POWER-SURVEYING.COM

TYPE OF SUBMITTAL:	FINAL PLAT
PREPARATION DATE:	JANUARY 31, 2023
REVISION DATE:	JULY 12, 2023
REVISION DATE:	OCTOBER 24, 2023
REVISION DATE:	JANUARY 19, 2024
JOB NO. 19-260	DWG: 19-260 FINAL.dwg

SHEET 7 OF 14

CLEAR CREEK TRANSIT VILLAGE

*** FINAL PLAT ***

A PORTION OF THE WEST HALF (W 1/2) OF SECTION 8, TOWNSHIP 3 SOUTH, RANGE 68 WEST
OF THE SIXTH PRINCIPAL MERIDIAN, COUNTY OF ADAMS, STATE OF COLORADO

SHEET 8 OF 14

PRC2023-00011

LEGEND OF SYMBOLS & ABBREVIATIONS

- SET REBAR & 1-1/2" DIAMETER YELLOW PLASTIC CAP, PLS 37929, TYPICAL UNLESS NOTED OTHERWISE
- MONUMENT FOUND, AS NOTED
- DIAM DIAMETER
- (C) CALCULATED
- (M) MEASURED
- (R) RECORD
- U.E. UTILITY EASEMENT
- BLOCK # LOT OR BLOCK NUMBER
- PUBLIC LANDS SURVEY SECTION LINE
- PLAT BOUNDARY LIMITS
- NEW LOT & TRACT LINE PER THIS PLAT
- PROPOSED EASEMENT
- EXISTING RECORD EASEMENT LINE
- ADJOINING PARCEL OR LOT LINE
- F.E.M.A. FLOOD BOUNDARY (AS NOTED)

FOR ADAMS COUNTY ROAD DEDICATION AND TRACTS B, D AND E DETAILS, SEE SHEET 15.

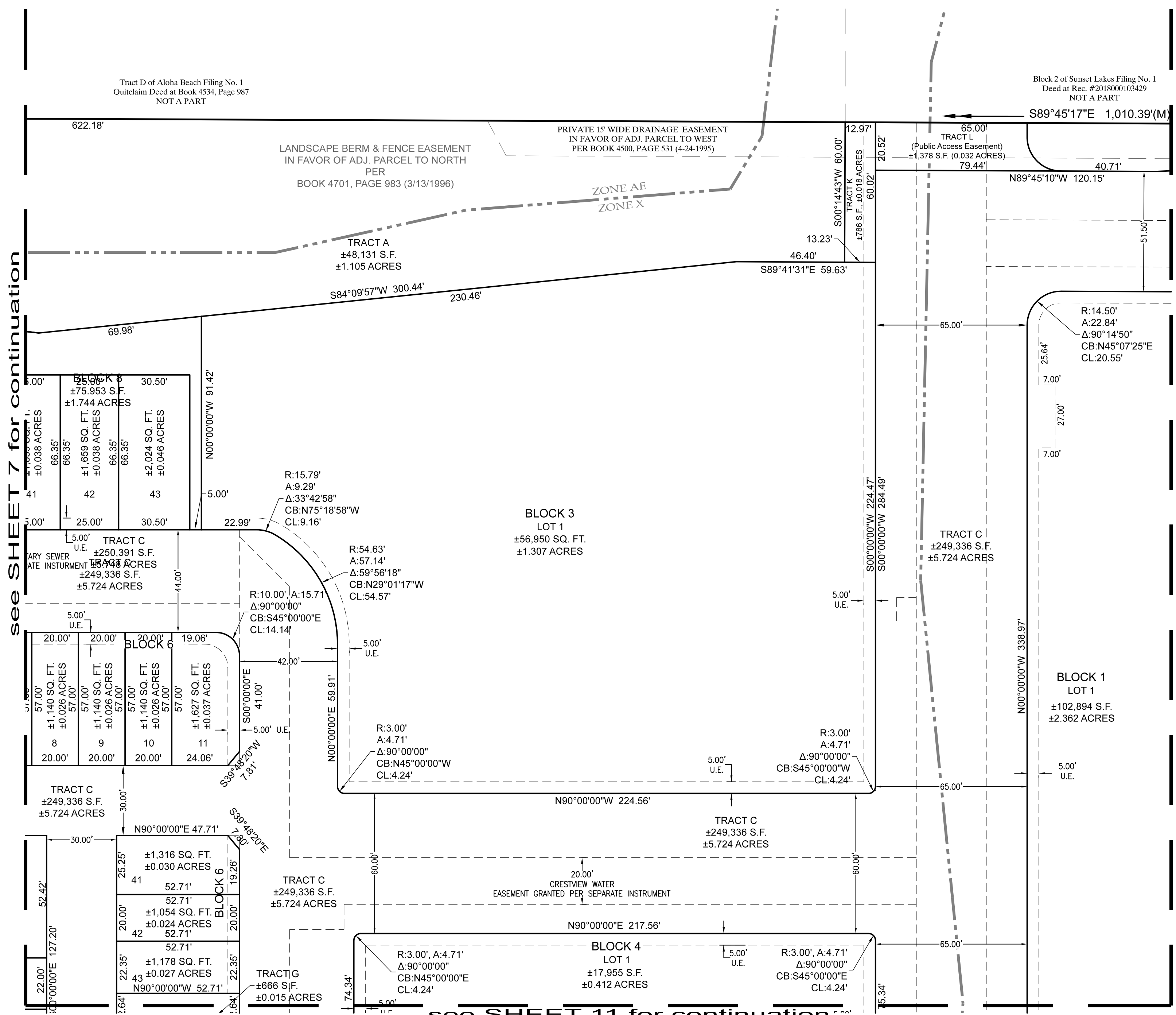
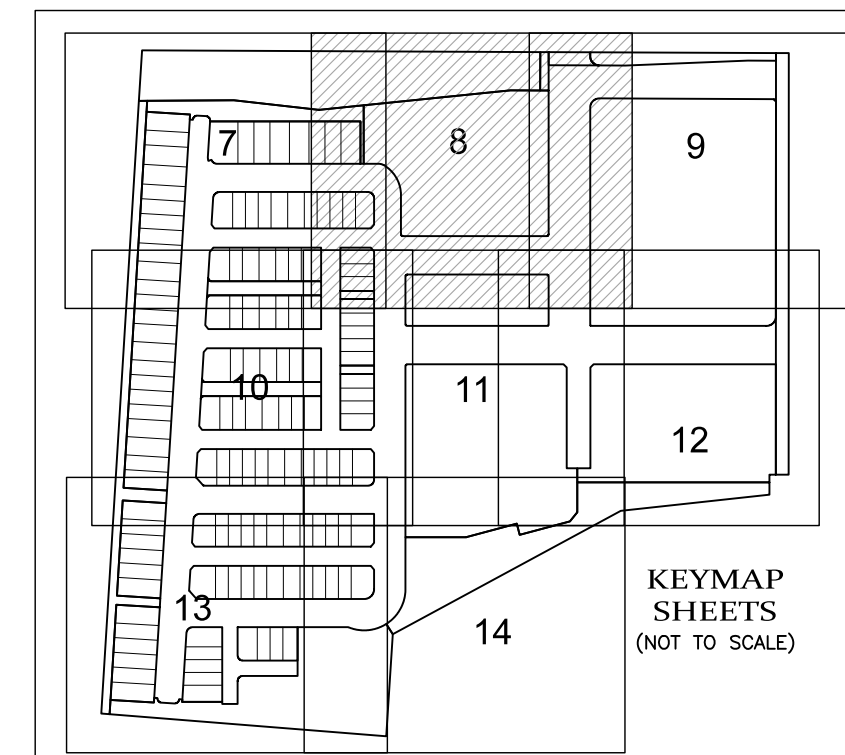

see SHEET 7 for continuation

see SHEET 9 for continuation

see SHEET 11 for continuation

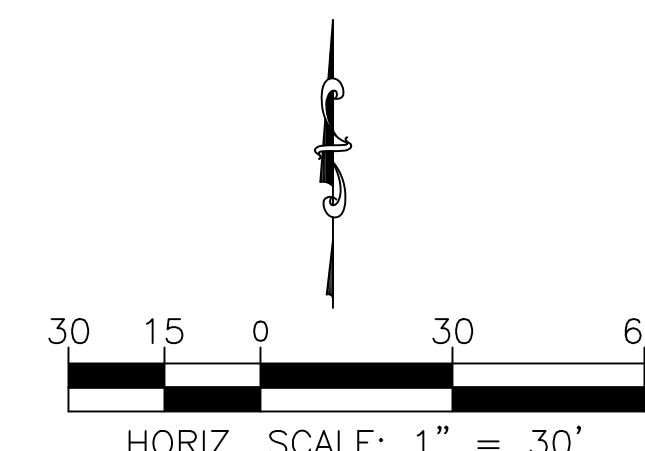

POWER
Surveying Company, Inc.
Established 1988
6911 BROADWAY
DENVER, COLORADO 80221

TYPE OF SUBMITTAL:	FINAL PLAT
PREPARATION DATE:	JANUARY 31, 2023
REVISION DATE:	JULY 12, 2023
REVISION DATE:	OCTOBER 24, 2023
REVISION DATE:	JANUARY 19, 2024
JOB NO. 19-260	DWG: 19-260 FINAL.dwg

SHEET 8 OF 14

CLEAR CREEK TRANSIT VILLAGE

*** FINAL PLAT ***

A PORTION OF THE WEST HALF (W 1/2) OF SECTION 8, TOWNSHIP 3 SOUTH, RANGE 68 WEST
OF THE SIXTH PRINCIPAL MERIDIAN, COUNTY OF ADAMS, STATE OF COLORADO

SHEET 9 OF 14

PRC2023-00011

LEGEND OF SYMBOLS & ABBREVIATIONS

- SET REBAR & 1-1/2" DIAMETER YELLOW PLASTIC CAP, PLS 37929, TYPICAL UNLESS NOTED OTHERWISE
- MONUMENT FOUND, AS NOTED
- DIAM DIAMETER
- (C) CALCULATED
- (M) MEASURED
- (R) RECORD
- U.E. UTILITY EASEMENT
- BLOCK # LOT OR BLOCK NUMBER
- PUBLIC LANDS SURVEY SECTION LINE
- PLAT BOUNDARY LIMITS
- NEW LOT & TRACT LINE PER THIS PLAT
- PROPOSED EASEMENT
- EXISTING RECORD EASEMENT LINE
- ADJOINING PARCEL OR LOT LINE
- F.E.M.A. FLOOD BOUNDARY (AS NOTED)

FOR ADAMS COUNTY ROAD DEDICATION AND TRACTS B, D AND E DETAILS, SEE SHEET 15.

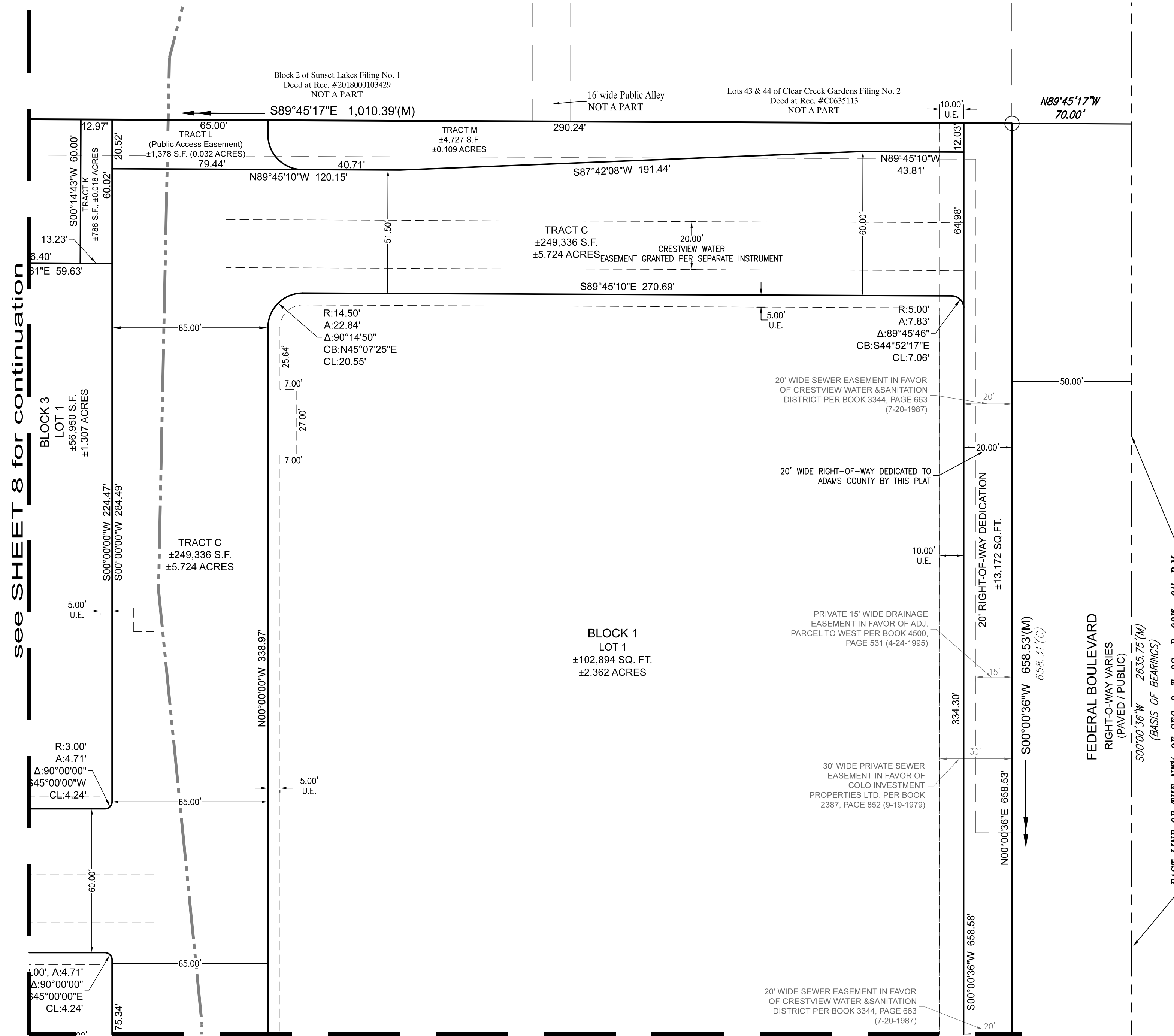
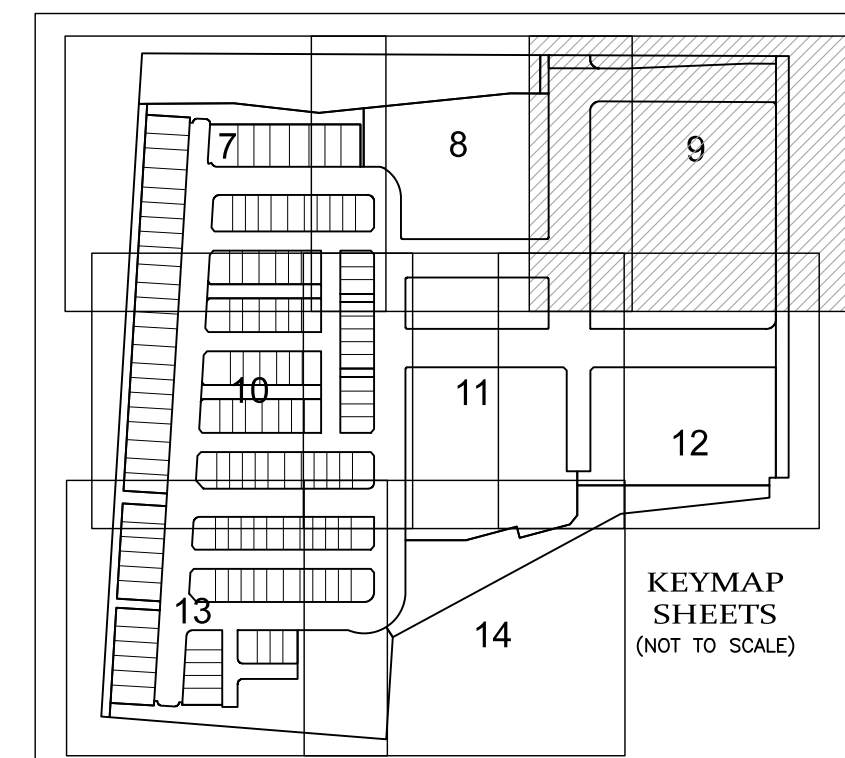

see SHEET 8 for continuation

see SHEET 12 for continuation

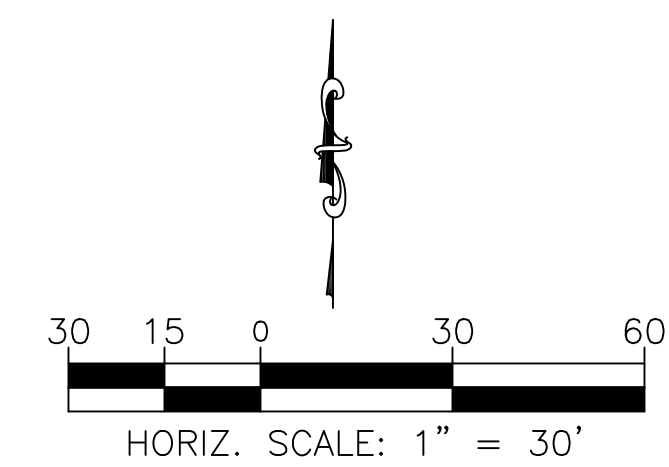

POWER
Surveying Company, Inc.
Established 1988
PH: 303-702-9517
FAX: 303-702-1488
WWW.POWER-SURVEYING.COM

TYPE OF SUBMITTAL:	FINAL PLAT
PREPARATION DATE:	JANUARY 31, 2023
REVISION DATE:	JULY 12, 2023
REVISION DATE:	OCTOBER 24, 2023
REVISION DATE:	JANUARY 19, 2024
JOB NO. 19-260	DWG: 19-260 FINAL.dwg

SHEET 9 OF 14

CLEAR CREEK TRANSIT VILLAGE

*** FINAL PLAT ***

PRC2023-00011

A PORTION OF THE WEST HALF (W 1/2) OF SECTION 8, TOWNSHIP 3 SOUTH, RANGE 68 WEST
OF THE SIXTH PRINCIPAL MERIDIAN, COUNTY OF ADAMS, STATE OF COLORADO

SHEET 10 OF 14

see SHEET 7 for continuation

LEGEND OF SYMBOLS & ABBREVIATIONS

- SET REBAR & 1-1/2" DIAMETER YELLOW PLASTIC CAP, PLS 37929, TYPICAL UNLESS NOTED OTHERWISE
- MONUMENT FOUND, AS NOTED
- DIAM DIAMETER
- (C) CALCULATED
- (M) MEASURED
- (R) RECORD
- U.E. UTILITY EASEMENT
- BLOCK # LOT OR BLOCK NUMBER
- PUBLIC LANDS SURVEY SECTION LINE
- PLAT BOUNDARY LIMITS
- NEW LOT & TRACT LINE PER THIS PLAT
- PROPOSED EASEMENT
- EXISTING RECORD EASEMENT LINE
- ADJOINING PARCEL OR LOT LINE
- F.E.M.A. FLOOD BOUNDARY (AS NOTED)

FOR ADAMS COUNTY ROAD DEDICATION AND TRACTS B, D AND E DETAILS, SEE SHEET 15.

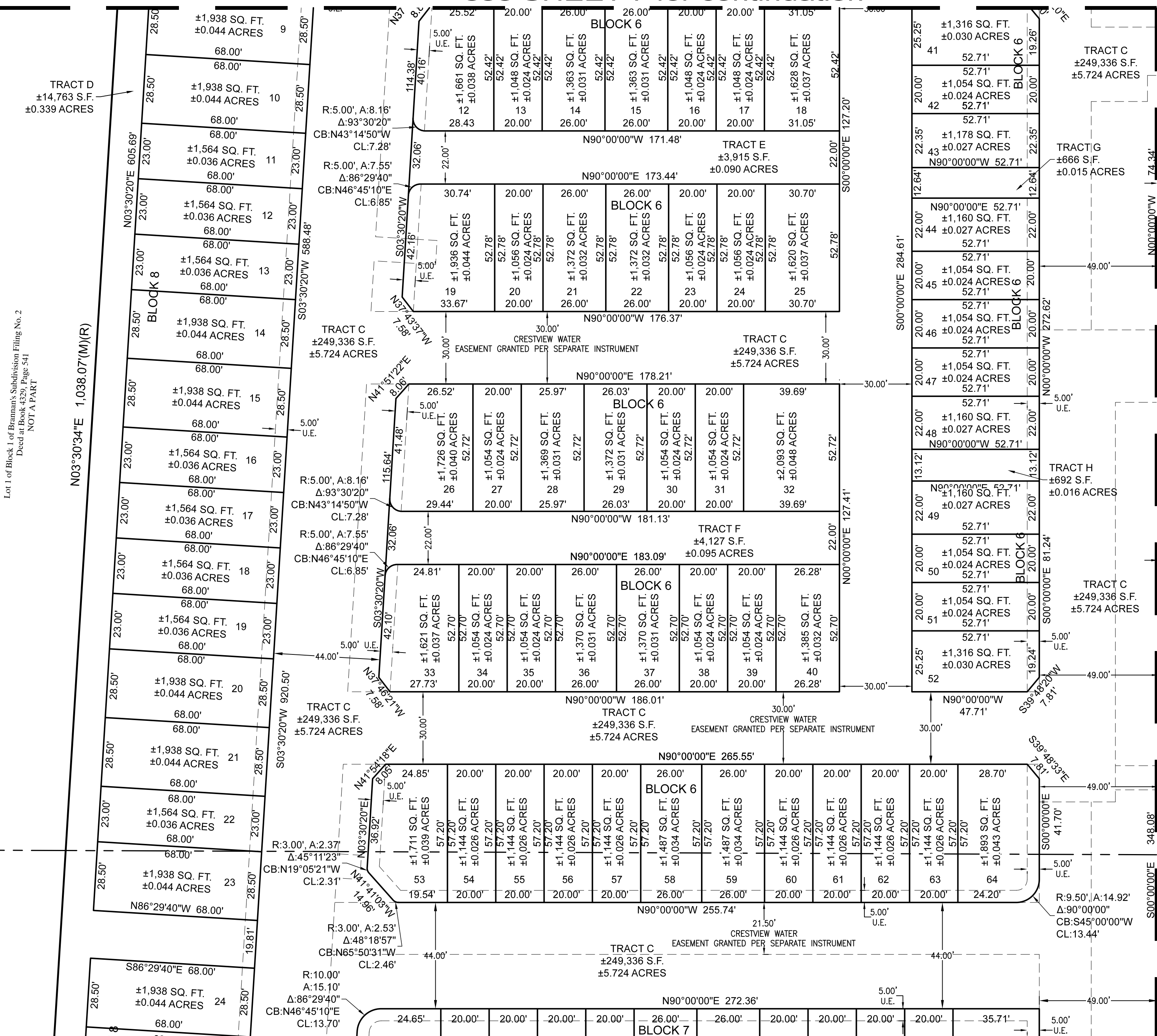
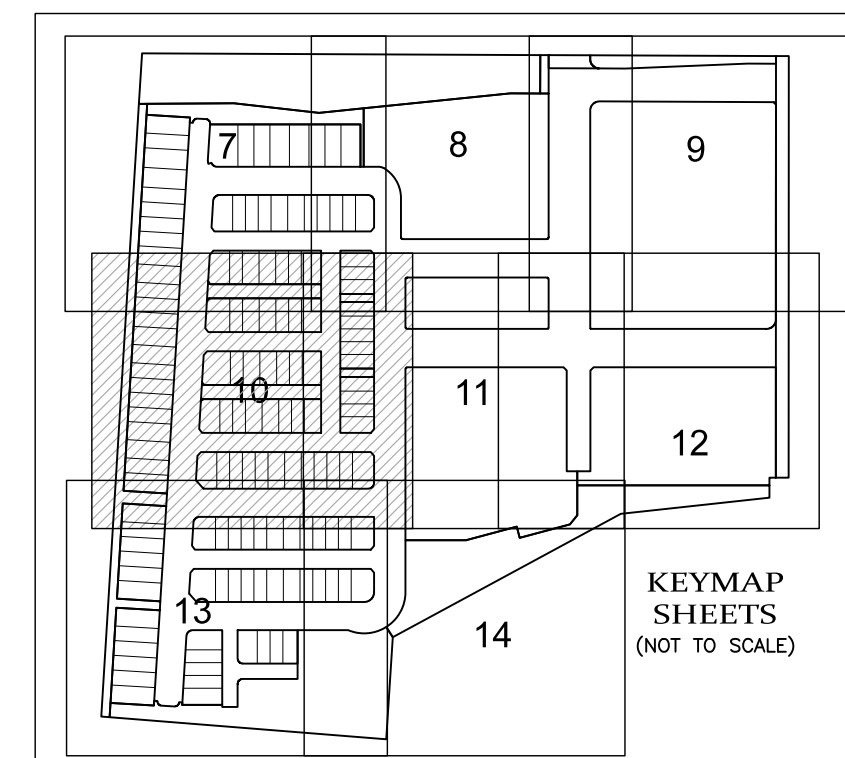

see SHEET 11 for continuation

see SHEET 13 for continuation

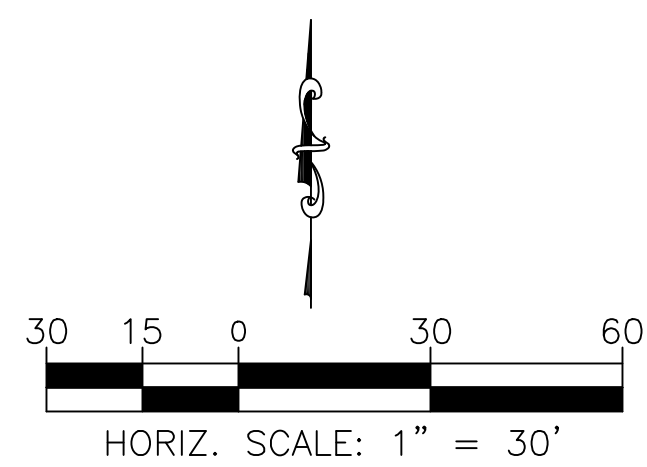

Lot 1 of Block 1 of Braman's Subdivision Filing No. 2
Deed at Book 4329, Page 541
NOT A PART

POWER Surveying Company, Inc.
Established 1988
6911 BRADSHAW DENVER, COLORADO 80221
PH: 303-752-9517 FAX: 303-752-1488 WWW.POWERSURVEYING.COM

TYPE OF SUBMITTAL:	FINAL PLAT
PREPARATION DATE:	JANUARY 31, 2023
REVISION DATE:	JULY 12, 2023
REVISION DATE:	OCTOBER 24, 2023
REVISION DATE:	JANUARY 19, 2024
JOB NO. 19-260	DWG: 19-260 FINAL.dwg

SHEET 10 OF 14

CLEAR CREEK TRANSIT VILLAGE

*** FINAL PLAT ***

A PORTION OF THE WEST HALF (W 1/2) OF SECTION 8, TOWNSHIP 3 SOUTH, RANGE 68 WEST
OF THE SIXTH PRINCIPAL MERIDIAN, COUNTY OF ADAMS, STATE OF COLORADO

SHEET 11 OF 14

PRC2023-00011

see SHEET 8 for continuation

LEGEND OF SYMBOLS & ABBREVIATIONS

- SET REBAR & 1-1/2" DIAMETER YELLOW PLASTIC CAP, PLS 37929, TYPICAL UNLESS NOTED OTHERWISE
- MONUMENT FOUND, AS NOTED
- DIAM DIAMETER
- (C) CALCULATED
- (M) MEASURED
- (R) RECORD
- U.E. UTILITY EASEMENT
- BLOCK # LOT OR BLOCK NUMBER
- PUBLIC LANDS SURVEY SECTION LINE
- PLAT BOUNDARY LIMITS
- NEW LOT & TRACT LINE PER THIS PLAT
- PROPOSED EASEMENT
- EXISTING RECORD EASEMENT LINE
- ADJOINING PARCEL OR LOT LINE
- F.E.M.A. FLOOD BOUNDARY (AS NOTED)

FOR ADAMS COUNTY ROAD DEDICATION AND TRACTS B, D AND E DETAILS, SEE SHEET 15.

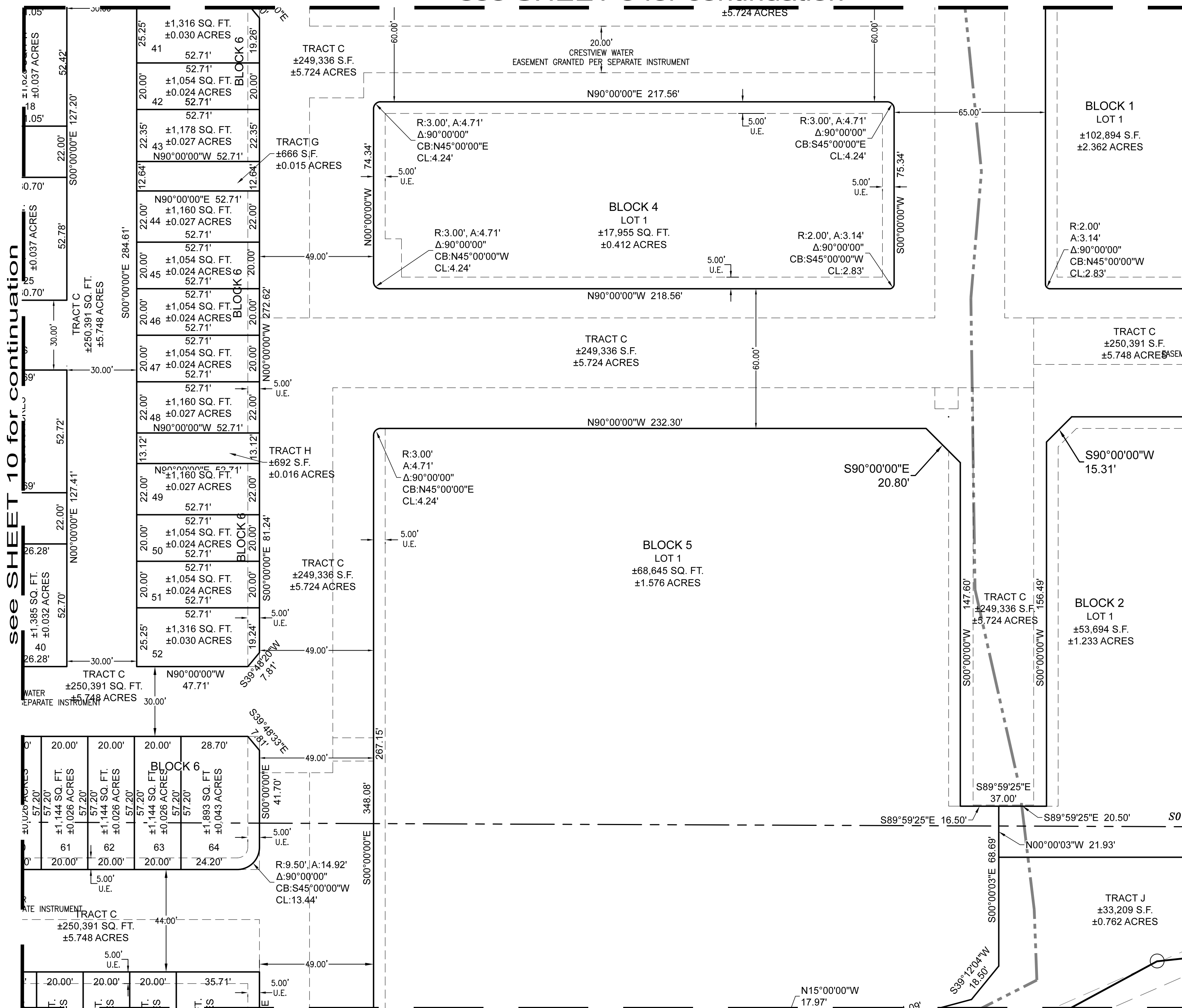
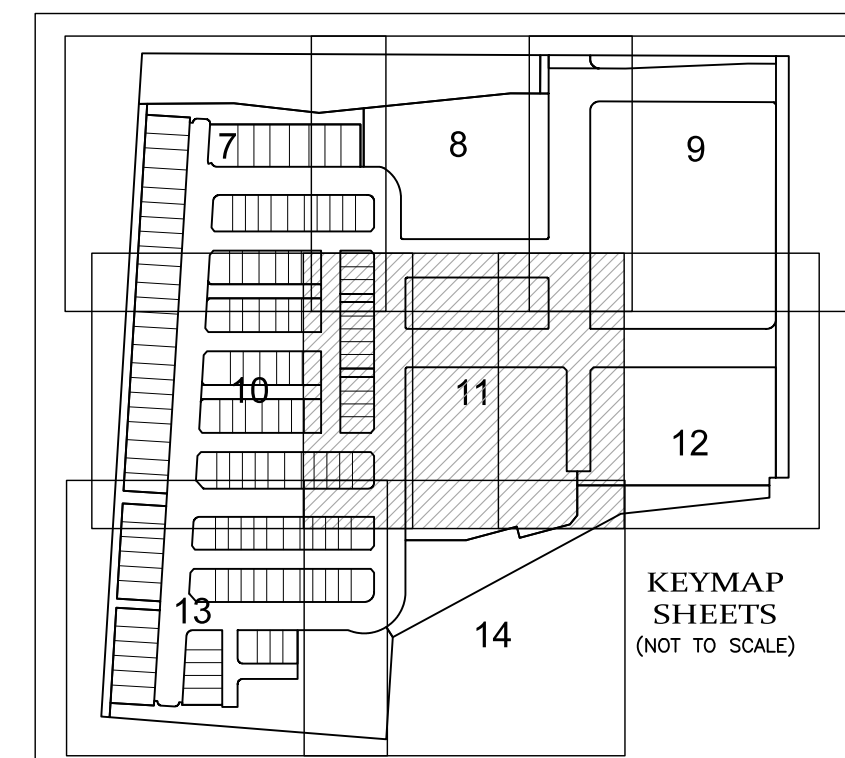

see SHEET 10 for continuation

see SHEET 12 for continuation

see SHEET 14 for continuation

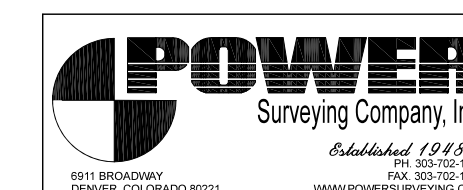
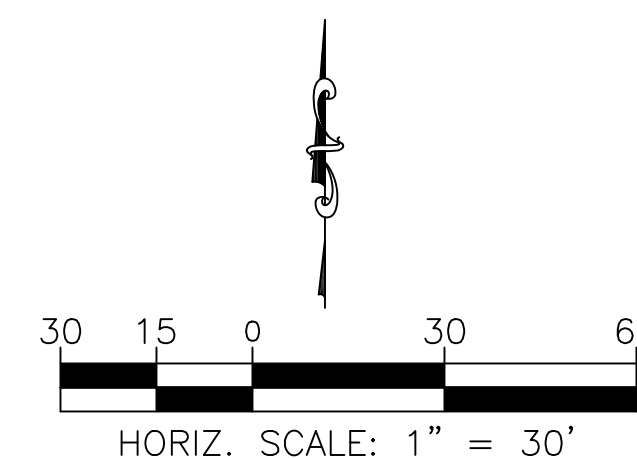

FINAL PLAT	
TYPE OF SUBMITTAL:	FINAL PLAT
PREPARATION DATE:	JANUARY 31, 2023
REVISION DATE:	JULY 12, 2023
REVISION DATE:	OCTOBER 24, 2023
REVISION DATE:	JANUARY 19, 2024
JOB NO. 19-260	DWG: 19-260 FINAL.dwg

CLEAR CREEK TRANSIT VILLAGE

*** FINAL PLAT ***

A PORTION OF THE WEST HALF (W 1/2) OF SECTION 8, TOWNSHIP 3 SOUTH, RANGE 68 WEST
OF THE SIXTH PRINCIPAL MERIDIAN, COUNTY OF ADAMS, STATE OF COLORADO

SHEET 12 OF 14

PRC2023-00011

see SHEET 9 for continuation

LEGEND OF SYMBOLS & ABBREVIATIONS

- SET REBAR & 1-1/2" DIAMETER YELLOW PLASTIC CAP, PLS 37929, TYPICAL UNLESS NOTED OTHERWISE
- MONUMENT FOUND, AS NOTED
- DIAM DIAMETER
- (C) CALCULATED
- (M) MEASURED
- (R) RECORD
- U.E. UTILITY EASEMENT
- BLOCK # LOT OR BLOCK NUMBER
- PUBLIC LANDS SURVEY SECTION LINE
- PLAT BOUNDARY LIMITS
- NEW LOT & TRACT LINE PER THIS PLAT
- PROPOSED EASEMENT
- EXISTING RECORD EASEMENT LINE
- ADJOINING PARCEL OR LOT LINE
- F.E.M.A. FLOOD BOUNDARY (AS NOTED)

FOR ADAMS COUNTY ROAD DEDICATION AND TRACTS B, D AND E DETAILS, SEE SHEET 15.

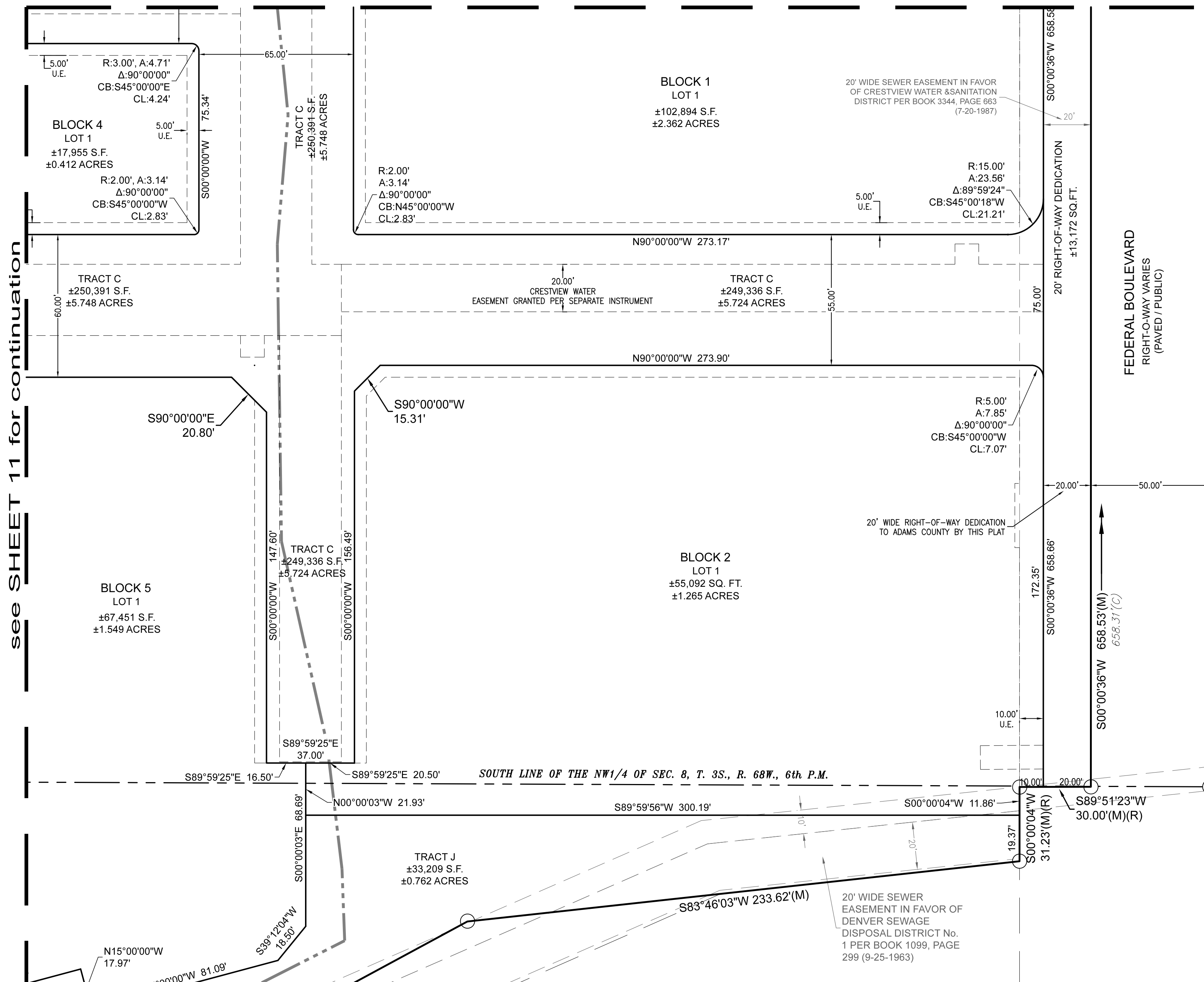
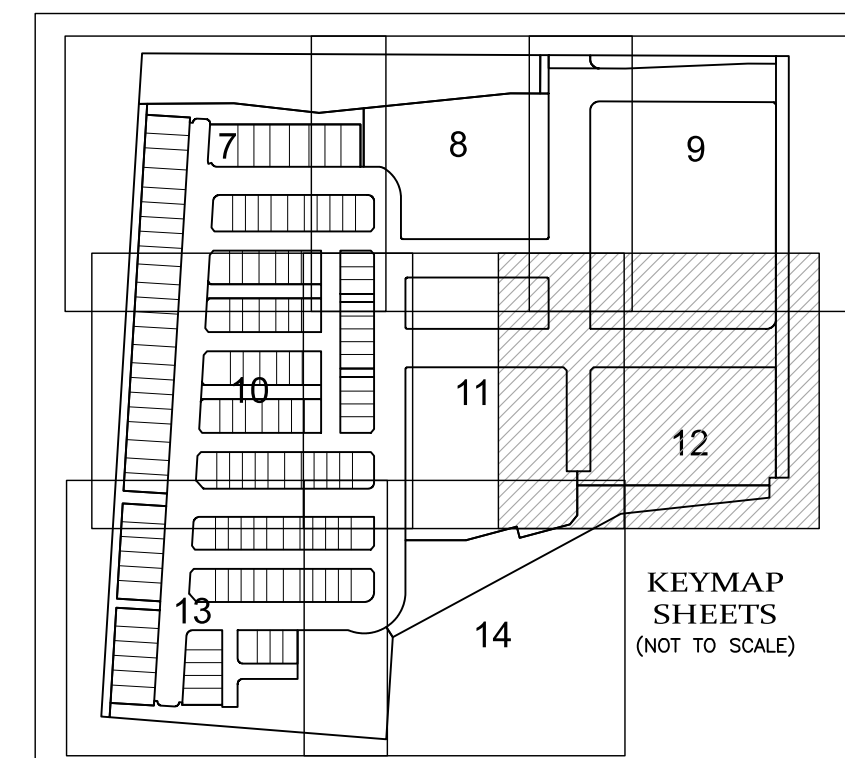

see SHEET 11 for continuation

see SHEET 14 for continuation

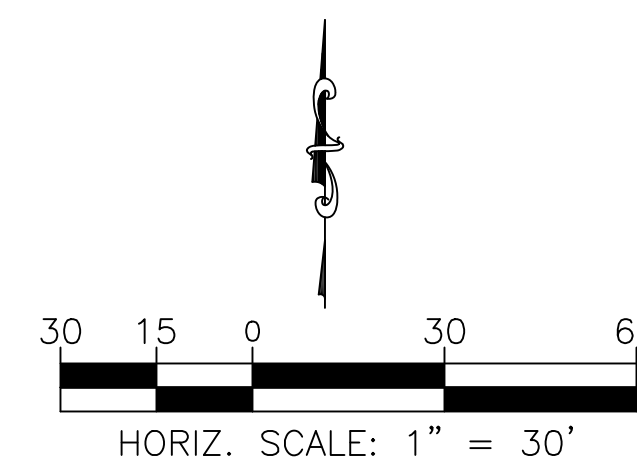

FINAL PLAT

<p>POWER Surveying Company, Inc. Established 1988 6911 BROADWAY DENVER, COLORADO 80221</p>	TYPE OF SUBMITTAL:	FINAL PLAT
	PREPARATION DATE:	JANUARY 31, 2023
	REVISION DATE:	JULY 12, 2023
	REVISION DATE:	OCTOBER 24, 2023
	REVISION DATE:	JANUARY 19, 2024
	JOB NO. 19-260	DWG: 19-260 FINAL.dwg

SHEET 12 OF 14

CLEAR CREEK TRANSIT VILLAGE

*** FINAL PLAT ***

A PORTION OF THE WEST HALF (W 1/2) OF SECTION 8, TOWNSHIP 3 SOUTH, RANGE 68 WEST
OF THE SIXTH PRINCIPAL MERIDIAN, COUNTY OF ADAMS, STATE OF COLORADO

SHEET 13 OF 14

PRC2023-00011

see SHEET 10 for continuation

LEGEND OF SYMBOLS & ABBREVIATIONS

- SET REBAR & 1-1/2" DIAMETER YELLOW PLASTIC CAP, PLS 37929, TYPICAL UNLESS NOTED OTHERWISE
- MONUMENT FOUND, AS NOTED
- DIAM DIAMETER
- (C) CALCULATED
- (M) MEASURED
- (R) RECORD
- U.E. UTILITY EASEMENT
- BLOCK # LOT OR BLOCK NUMBER
- PUBLIC LANDS SURVEY SECTION LINE
- PLAT BOUNDARY LIMITS
- NEW LOT & TRACT LINE PER THIS PLAT
- PROPOSED EASEMENT
- EXISTING RECORD EASEMENT LINE
- ADJOINING PARCEL OR LOT LINE
- F.E.M.A. FLOOD BOUNDARY (AS NOTED)

FOR ADAMS COUNTY ROAD DEDICATION AND TRACTS B, D AND E DETAILS, SEE SHEET 15.

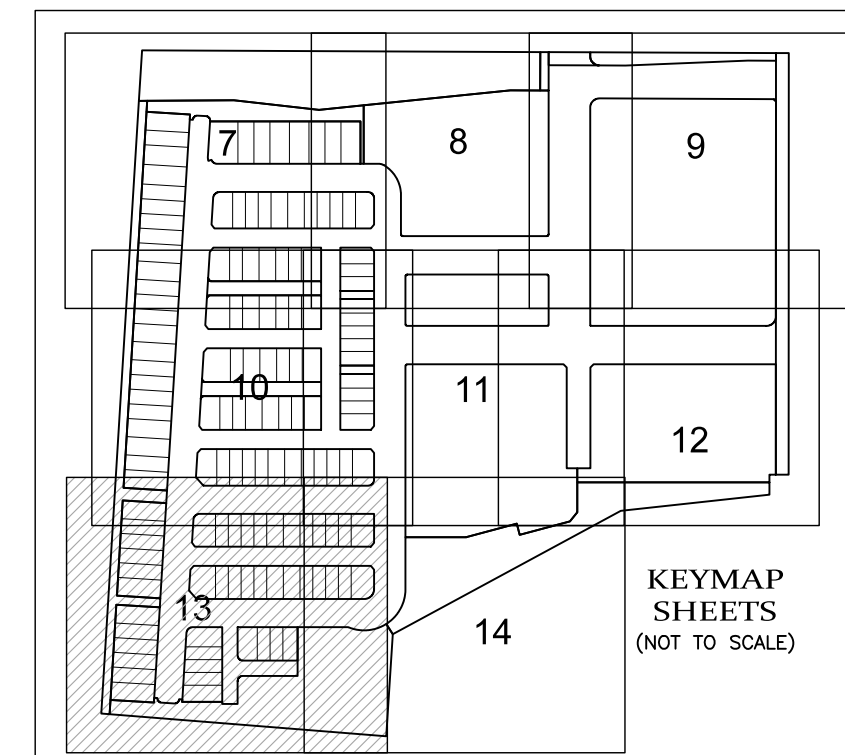

CURVE	RADIUS	ARC LENGTH	DELTA ANGLE	CHORD BEARING	CHORD LENGTH
C3	7.00'	11.05'	90°22'11"	S41°41'50"E	9.94'
C4	7.00'	10.94'	89°34'31"	N48°17'35"E	9.86'
C5	8.00'	12.57'	90°02'57"	N45°01'29"E	11.32'

LINE	BEARING	DISTANCE
L5	N03°30'20"E	7.50'
L6	S86°29'40"E	5.00'
L7	S86°55'09"E	20.00'
L8	S86°29'40"E	5.00'
L9	S03°30'20"W	3.86'
L10	N90°00'00"E	62.61'
L11	S00°00'00"E	3.21'
L12	N90°00'00"E	24.00'
L13	N00°00'00"W	35.78'

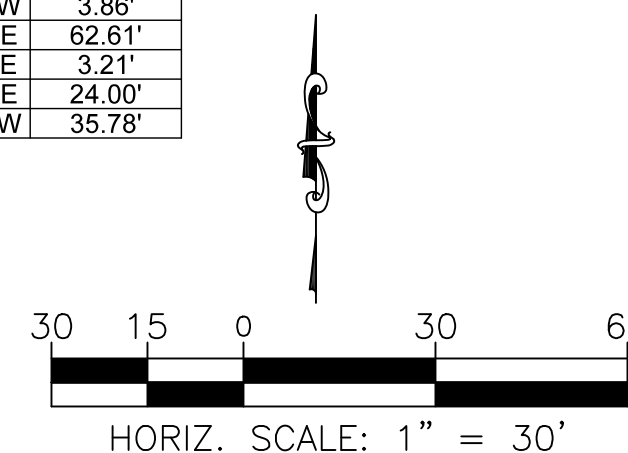

see SHEET 14 for continuation

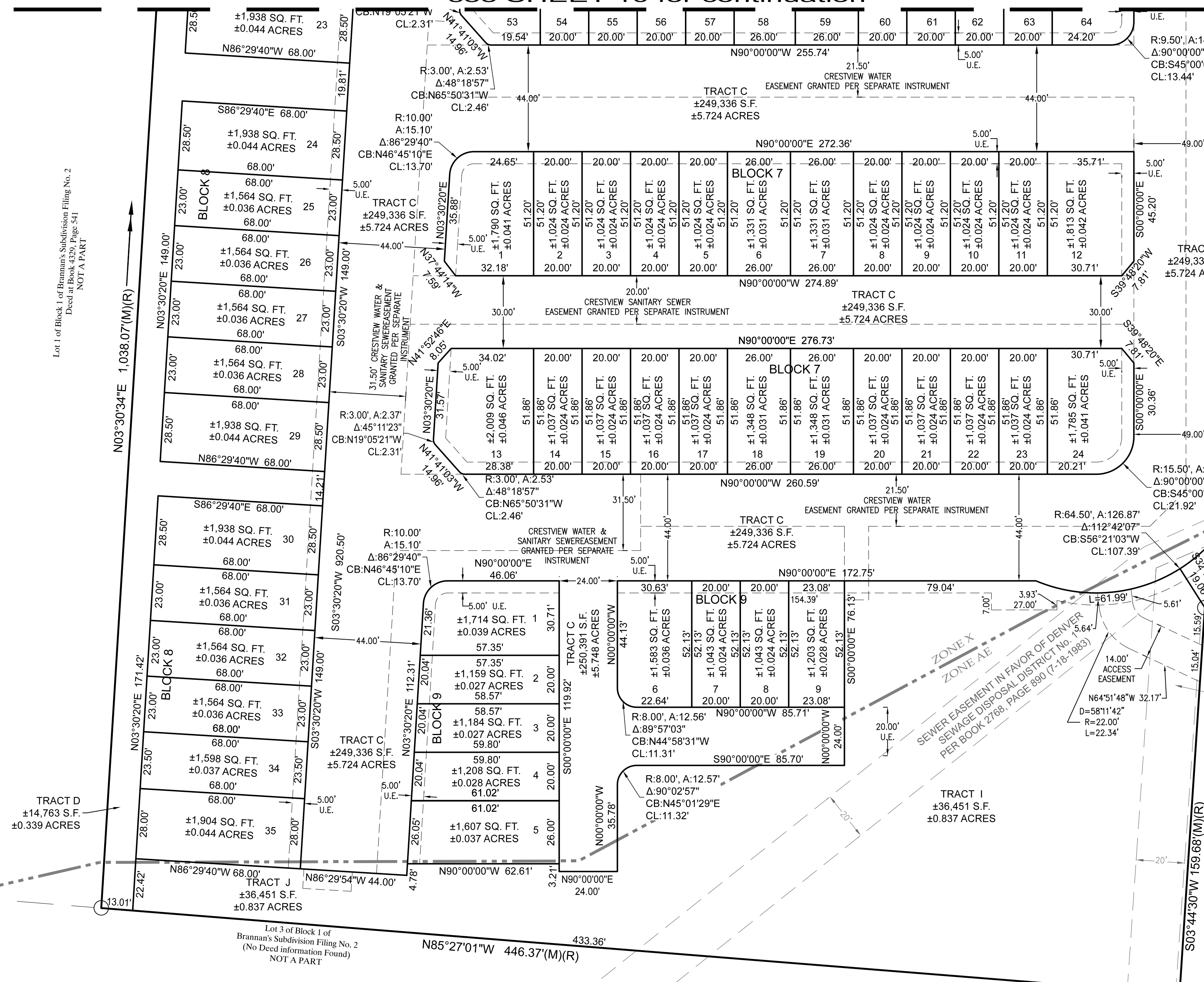

Lot 1 of Block 1 of Brannan's Subdivision Filing No. 2 Deed at Book 4329, Page 541 NOT A PART

Lot 3 of Block 1 of Brannan's Subdivision Filing No. 2 (No Deed information Found) NOT A PART

FINAL PLAT

POWER
Surveying Company, Inc.
Established 1988
6911 BRADSHAW DENVER, COLORADO 80221
PH: 303-752-9517 FAX: 303-752-1488 WWW.POWER-SURVEYING.COM

TYPE OF SUBMITTAL:	FINAL PLAT
PREPARATION DATE:	JANUARY 31, 2023
REVISION DATE:	JULY 12, 2023
REVISION DATE:	OCTOBER 24, 2023
REVISION DATE:	JANUARY 19, 2024
JOB NO. 19-260	DWG: 19-260 FINAL.dwg

SHEET 13 OF 14

CLEAR CREEK TRANSIT VILLAGE

*** FINAL PLAT ***

A PORTION OF THE WEST HALF (W 1/2) OF SECTION 8, TOWNSHIP 3 SOUTH, RANGE 68 WEST
OF THE SIXTH PRINCIPAL MERIDIAN, COUNTY OF ADAMS, STATE OF COLORADO

SHEET 14 OF 14

see SHEET 11 for continuation

PRC2023-00011

LEGEND OF SYMBOLS & ABBREVIATIONS

- SET REBAR & 1-1/2" DIAMETER YELLOW PLASTIC CAP, PLS 37929, TYPICAL UNLESS NOTED OTHERWISE
- MONUMENT FOUND, AS NOTED
- DIAM DIAMETER
- (C) CALCULATED
- (M) MEASURED
- (R) RECORD
- U.E. UTILITY EASEMENT
- BLOCK # LOT OR BLOCK NUMBER
- PUBLIC LANDS SURVEY SECTION LINE
- PLAT BOUNDARY LIMITS
- NEW LOT & TRACT LINE PER THIS PLAT
- PROPOSED EASEMENT
- EXISTING RECORD EASEMENT LINE
- ADJOINING PARCEL OR LOT LINE
- F.E.M.A. FLOOD BOUNDARY (AS NOTED)

FOR ADAMS COUNTY ROAD DEDICATION AND TRACTS B, D AND E DETAILS, SEE SHEET 15.

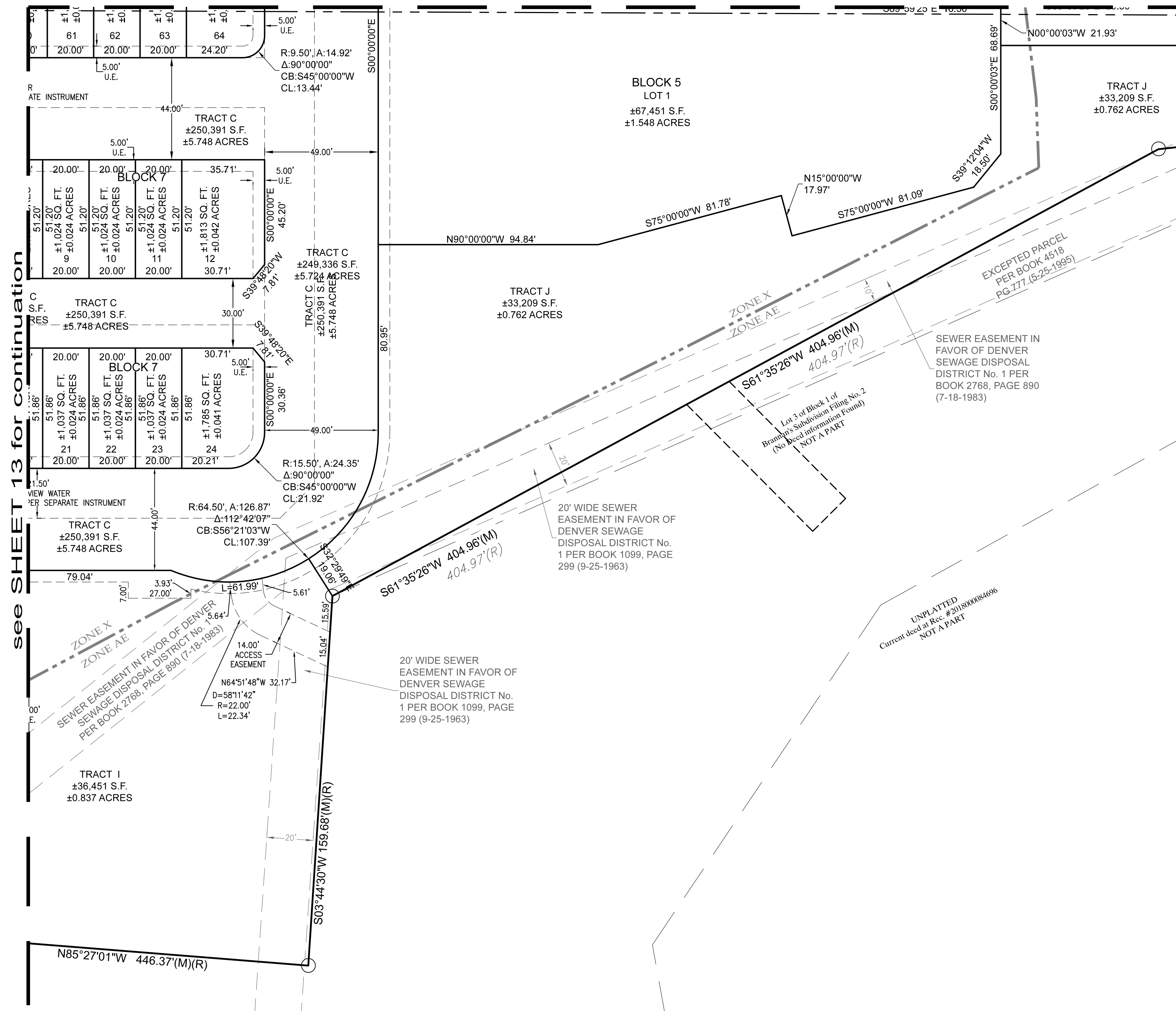
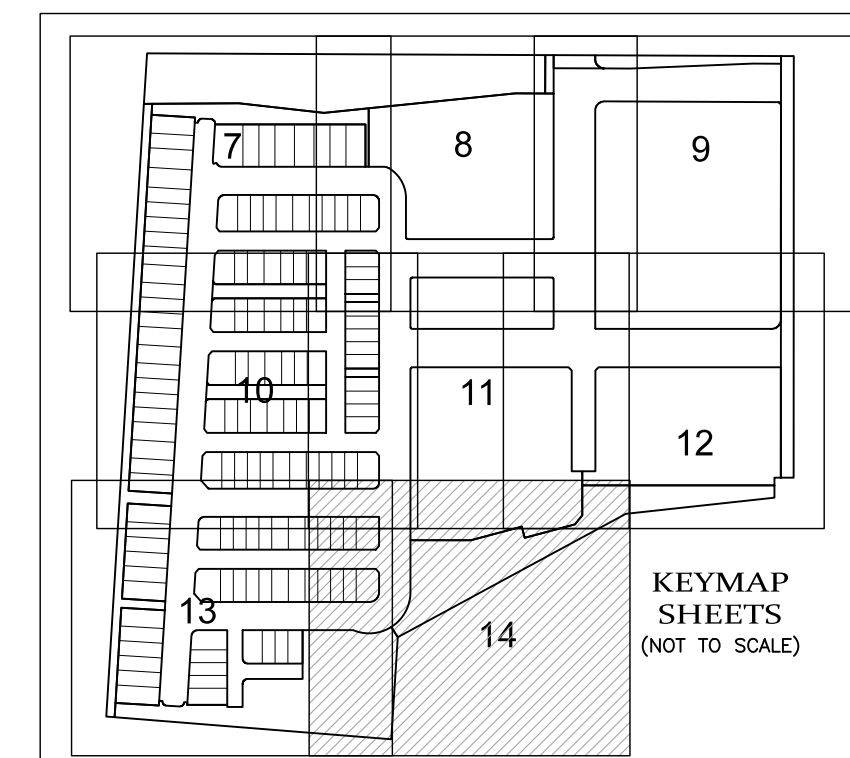

see SHEET 13 for continuation

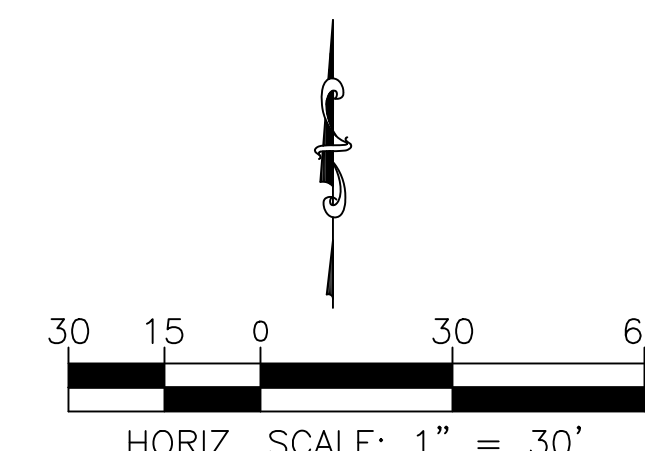

POWER
Surveying Company, Inc.
Established 1988
PH: 303-752-9517
FAX: 303-752-1438
WWW.POWER-SURVEYING.COM

TYPE OF SUBMITTAL:	FINAL PLAT
PREPARATION DATE:	JANUARY 31, 2023
REVISION DATE:	JULY 12, 2023
REVISION DATE:	OCTOBER 24, 2023
REVISION DATE:	JANUARY 19, 2024
JOB NO. 19-260	DWG: 19-260 FINAL.dwg

FINAL PLAT

SHEET 14 OF 14

SUBDIVISION IMPROVEMENTS AGREEMENT

THIS AGREEMENT is made and entered into this ___ day of _____, 2024, between Clear Creek Development, LLC, a Delaware limited liability company qualified to do business in Colorado (“Developer”), whose address is 10808 S. River Front Parkway, Suite 378, South Jordan, Utah 84095 and the Board of County Commissioners of the County of Adams, State of Colorado (“County”), whose address is 4430 S. Adams County Parkway, Brighton, CO 80601.

WITNESSETH:

WHEREAS, Developer is the owner of real property in the County of Adams, State of Colorado, as described in Exhibit “A” attached hereto, and by this reference made a part hereof.

WHEREAS, it is provided by resolution of the Board of County Commissioners, County of Adams, that where designated the Developer shall have entered into a written agreement with the County to install public and/or private improvements, and to deed land for public purposes or right-of-way.

NOW, THEREFORE, in consideration of the foregoing, the parties hereto promise, covenant, and agree as follows:

- 1. Engineering Services.** Developer shall furnish, at its own expense, all engineering and other services in connection with the design and construction of the improvements described and detailed on Exhibit “B” attached hereto, and by this reference made a part hereof (“Improvements”).
- 2. Drawings and Estimates.** The Developer shall furnish drawings and cost estimates for all improvements described and detailed on Exhibit “B” for approval by the County. Upon request, the Developer shall furnish one set of reproducible “as built” drawings and a final statement of construction costs to the County.
- 3. Construction.** Developer shall furnish and construct (or cause Clear Creek Transit Metropolitan District No. 1 to construct – “District”), at its own expense and in accordance with drawings and materials approved by the County, the improvements described and detailed on Exhibit “B”.
- 4. Time for Completion.** Improvements shall be completed according to the terms of this agreement within “construction completion date” appearing in Exhibit “B”. The Director of Community and Economic Development Department may for good cause grant extension of time for completion of any part or all of improvements appearing on said Exhibit “B”. Any extension greater than 180 days may be approved only by the Board of County Commissioners. All extensions of time shall be in written form only.
- 5. Warranties of Developer.** Developer warrants that the Improvements shall be installed in good workmanlike manner and in substantial compliance with the plans and requirements of this Agreement and shall be substantially free of defects in materials and workmanship. These warranties of Developer shall remain in effect until Final Acceptance of the improvements by the County.
- 6. Guarantee of Compliance.** Developer shall furnish (or shall cause District to furnish) to the County a cash escrow deposit, bond, letter of credit or other acceptable collateral, releasable only by the County, to guarantee compliance with this agreement. Said collateral shall be in the amount of \$1,250,160.59, which includes twenty percent (20%) to cover administration and five percent (5%) per year for the term of the Agreement to cover inflation. Upon approval of the final plat, completion of said improvements constructed according to the terms of this agreement, and preliminary acceptance by the Director of Public Works in accordance with section 5-02-05-01 of the County’s Development Standards and Regulations, the collateral shall be released. Completion of said improvements shall be determined solely by the County, and a reasonable part of said collateral, up to 20%, may be retained to guarantee maintenance of public improvements for a period of one year from the date of preliminary acceptance.

Collateral shall be furnished in the amount required and in a form acceptable to the Board of County Commissioners prior to final plat approval. No building permits shall be issued until the final plat has been approved and the improvements described in Exhibit "B" have been preliminarily accepted by the Department of Public Works.

7. **Acceptance and Maintenance of Public Improvements.** All improvements designated "public" on Exhibit "B" shall be public facilities and become the property of the County or other public agencies upon acceptance. During the period of one year from and after the acceptance of public improvements, the Developer shall, at its own expense, make all needed repairs or replacement due to defective materials or workmanship which, in the opinion of the County, becomes necessary. If, within ten days of written notice to the Developer from the County requesting such repairs or replacements, the Developer has not undertaken with due diligence to make the same, the County may make such repairs or replacements at the Developer's expense. In the case of an emergency such written notice may be waived.
8. **Successors and Assigns.** This agreement shall be binding upon the heirs, executors, personal representatives, successors, and assigns of the Developer, and shall be deemed a covenant running with the real property as described in Exhibit "A" attached hereto. From and after any transfer of fee title to all of the Property, the transferee shall be deemed to have assumed all rights and obligations of "Developer" owed to the County hereunder arising after the date of transfer.
9. **Improvements and Dedication.** The undersigned Developer hereby agrees to provide the following improvements, and to dedicate described property.

A. **Improvements.**

Public Improvements:

The Public Improvements consist of widening Federal to provide a right turn lane and constructing new curb, gutter and sidewalk along the project frontage. All other improvements proposed with the project will be privately owned and maintained by the Metro District. See Exhibit "B" for description, estimated quantities and estimated construction costs.

The improvements shall be constructed in accordance with all County requirements and specifications in accordance with the approved plans and time schedule as indicated in Exhibit "B".

- B. **Public dedication of land for right-of-way purposes or other public purpose.** Upon approval of this agreement by the Board of County Commissioners, the Developer hereby agrees to convey by special warranty deed to the County of Adams the following described land for right-of-way or other public purposes:

20' right-of-way dedication along the eastern boundary of the property adjacent to Federal Boulevard as specifically set forth on the plat.

Developer shall pay the additional cash in lieu fee of \$883,486.40 to County no later than the date the final plat is recorded.

10. **Default by Developer.** A default by the Developer shall exist if (a) Developer fails to construct the Improvements in substantial compliance with the plans and the other requirements of this Agreement; (b) Developer fails to complete construction of the Improvements by the Completion Date provided herein as the same may be extended; (c) Developer fails to cure any noncompliance specified in any written notice of noncompliance within a reasonable time after receipt of the notice of noncompliance; (d) Developer otherwise breaches or fails to comply with any obligation of Developer under this Agreement.
- A. **Remedies of County.** If the County, after notice, determines that a default by Developer exists, and if Developer fails to cure such default within the time specified by the County

(but in no event less than thirty days), the County shall be entitled to (a) make a draw on the collateral for the amount reasonably determined by the County to be necessary to cure the default in a manner consistent with the approved Plans up to the face amount of the collateral; and (b) sue the Developer for recovery of any amount necessary to cure the default over and above the amount available in the collateral provided.

B. **County Right to Completion of Improvements.** The right of the County to complete or cause completion of the Improvements as herein provided shall include the following rights:

a. The County shall have the right to complete the Improvements, in substantial accordance with the plans, the estimated costs, and other requirements of this Agreement, either itself or by contract with a third party or by assignment of its rights to a successor developer who has acquired the Property by purchase, foreclosure, or otherwise. The County, any contractor under the County, or any such successor developer, their agents, subcontractors and employees shall have the non-exclusive right to enter upon the streets and easements shown on the final plat of the Subdivision and upon any part of the Subdivision owned by Developer for the purpose of completing the Improvements.

C. **Use of Funds by County.** Any funds obtained by the County through collateral, or recovered by the County from Developer by suit or otherwise, shall be used by the County to pay the costs of completion of the Improvements substantially in accordance with the plans and the other requirements of this Agreement and to pay the reasonable costs and expenses of the County in connection with the default by Developer, including reasonable attorneys' fees.

Developer:

Clear Creek Development, LLC, a Delaware limited liability company

By: Thistle Creek QOF I, L.P., a Delaware limited partnership, its Managing Member

By: Thistle Creek QOF I GP, LLC, a Utah limited liability company, its General Partner

By: _____

Printed Name: _____

Its: _____

The foregoing instrument was acknowledged before me this ____ day of _____, 2024, by _____ as _____ of Thistle Creek QOF I GP, LLC, a Utah limited liability company, General Partner of Thistle Creek QOF I, L.P., a Delaware limited partnership, Managing Member of Clear Creek Development, LLC, a Delaware limited liability company.

My commission expires: _____

Address: _____

Notary Public

APPROVED BY resolution at the meeting of _____, 20__.

Collateral to guarantee compliance with this agreement and construction of public improvements shall be required in the amount of \$1,250,160.59. No building permits shall be issued until said collateral is furnished in the amount required and in a form acceptable to the Board of County Commissioners and the improvements in Exhibit B have been preliminarily accepted by Public Works.

ATTEST:

BOARD OF COUNTY COMMISSIONERS
ADAMS COUNTY, COLORADO

Clerk of the Board

Chair

EXHIBIT A

Legal Description:

LOT 2, BLOCK 1, BRANNAN'S SUBDIVISION FILING NO. 2, AND AS AMENDED BY AFFIDAVIT OF CORRECTION RECORDED JANUARY 19, 1995 IN BOOK 4455 AT PAGE 542, EXCEPT THAT PART CONVEYED TO THE COUNTY OF ADAMS BY WARRANTY DEED MADE A PART OF RESOLUTION RECORDED MAY 25, 1995 IN BOOK 4518 AT PAGE 777, COUNTY OF ADAMS, STATE OF COLORADO

AND

TRACT "A", BRANNAN'S SUBDIVISION, FILING NO. 1, COUNTY OF ADAMS, STATE OF COLORADO

LESS

PROPERTY DEDICATED TO THE COUNTY PURSUANT TO SECTION 9.B OF THIS AGREEMENT

EXHIBIT B

Public Improvements: Street Name/s

<u>Description</u>	<u>Est. Quantity</u>	<u>Est. Unit Cost</u>	<u>Est. Construct. Cost</u>
--------------------	----------------------	-----------------------	-----------------------------

SEE ATTACHED

Construction Completion Date: SEE ATTACHED

Initials or signature of Developer: _____

BLANK SUBDIVISION
Case No. XXX

Common Costs					Public Improvements (Federal Blvd)					Cost Total	
Item	Quantity	Unit Cost	Unit	Cost	Item	Quantity	Unit Cost	Unit	Cost	Common Costs	
Mobilization	1	\$ 15,000.00	LS	\$15,000.00	Asphalt Removal	671	\$ 30.00	SY	\$20,130.00	\$85,000.00	
Pavement Marking	1	\$ 40,000.00	LS	\$40,000.00	Curb Removal	521	\$ 15.00	LF	\$7,815.00	Public Improvements (Federal Blvd)	\$702,491.50
Erosion and Sediment Control	1	\$ 20,000.00	LS	\$20,000.00	Clear & Grubbing	1129	\$ 0.50	SY	\$564.50	Private Improvement - Water Quality Pond	\$289,699.44
Signage	1	\$ 10,000.00	LS	\$10,000.00	Bollard Removal	2	\$ 500.00	EA	\$1,000.00	Subtotal:	\$992,190.94
				\$0.00	Sidewalk Concrete Removal	304	\$ 20.00	SY	\$6,080.00		
				\$0.00	Hydrant Relocation	1	\$ 500.00	EA	\$500.00	20% Administration Cost	\$198,438.19
				\$0.00	Overhead Power Removal	1	\$ 10,000.00	EA	\$10,000.00	Subtotal:	\$1,190,629.13
				\$0.00	Stablized Subgrade	1121	\$ 2.00	SY	\$2,242.00		
				\$0.00	Aggregate Base Course	1121	\$ 15.00	SY	\$16,815.00		
				\$0.00	Hot Mix Asphalt	1121	\$ 50.00	SY	\$56,050.00		
				\$0.00	Hot Mix Asphalt 2" Overlay	341	\$ 35.00	SY	\$11,935.00		
				\$0.00	Concrete Sidewalk	304	\$ 100.00	SY	\$30,400.00		
				\$0.00	Concrete Curb Ramp	4	\$ 5,500.00	EA	\$22,000.00	5% per year Inflation	\$59,531.46
				\$0.00	Curb & Gutter Type 2	515	\$ 22.00	LF	\$11,330.00	Grand Total:	\$1,250,160.59
				\$0.00	Concrete Pan	161	\$ 140.00	SY	\$22,540.00		
				\$0.00	18" RCP Storm Pipe	9	\$ 100.00	LF	\$900.00		
				\$0.00	Adjustment of Storm Manhole	1	\$ 850.00	EA	\$850.00	Construction Completion Date:	5/1/2025
				\$0.00	Storm Manhole (5')	1	\$ 4,600.00	EA	\$4,600.00		
				\$0.00	Connect to Existing Storm	1	\$ 750.00	EA	\$750.00	Number of Year for Completion:	1
				\$0.00	Storm Cleanout	1	\$ 350.00	EA	\$350.00	(Round up to nearest year)	
				\$0.00	4" Under Drain	112	\$ 40.00	LF	\$4,480.00		
				\$0.00	RipRap Type M	2	\$ 100.00	CY	\$200.00		
				\$0.00	Sidewalk Chase (3')	1	\$ 200.00	EA	\$200.00		
				\$0.00	Rain Garden Installation	1	\$ 35,000.00	EA	\$35,000.00		
				\$0.00	8" PVC Water Pipe	90	\$ 60.00	LF	\$5,400.00		
				\$0.00	8" Gate Valve	2	\$ 2,500.00	EA	\$5,000.00		
				\$0.00	8" Tee	2	\$ 1,300.00	EA	\$2,600.00		
				\$0.00	6" Ductile Iron Pipe for Fire Hydrant	47	\$ 80.00	LF	\$3,760.00		
				\$0.00	Fire Hydrant Assembly	1	\$ 10,000.00	EA	\$10,000.00		
				\$0.00	Connect into Existing Water Main	3	\$ 3,000.00	EA	\$9,000.00		
				\$0.00	Traffic Signal Improvements	1	\$ 400,000.00	EA	\$400,000.00		
				\$0.00					\$0.00		
				\$0.00					\$0.00		
				Subtotal:					\$85,000.00		
									Subtotal:		\$702,491.50

