

## The National Radio Show

ONCE again the annual exhibition of the British domestic radio and television receiver manufacturers opens its doors at Earls Court and we are to experience the bustle and excitement, the sights and sounds, both familiar and unexpected, which combine to create the special atmosphere which is associated with this annual event. True things are not as hectic as they are remembered in the early and middle 1930s when the pace of technical development from the primitive to the sophisticated was at its hottest, and we shall not lack the depressive cynicism of those blasé individuals who pretend to find nothing new—"The mixture as before, old boy." But let no one mistake stability for stagnation. A little probing behind the familiar facade has never yet failed to produce more than enough to fill the time of the technically minded visitor with interesting food for thought.

To get the best out of an exhibition in the limited time at one's disposal it should be tackled rather like an examination paper. One should go first for the obvious questions (and here we hope that a study of the guide to the stands given elsewhere in this issue will enable readers to decide their individual priorities); then in the time that remains one makes sure that the manufacturers' stands which have not so far been visited do not spring some last-minute surprises. It is not unknown for manufacturers to withhold information until the opening day, or even to surprise themselves by last minute brainwaves!

Among things we shall look for first are the new transistor v.h.f./f.m. battery sets to see how they compare with the "no-compromise" B.B.C. design now being described in this journal. We shall be interested in the picture quality of 405 lines as displayed on 21-in tubes and how far set makers have been successful in solving the now vital problem of ensuring correct interlace. And, of course, transistors which will be shown in embryo and in their multifarious applications in ways which cannot fail to add something to the knowledge of every visitor, layman, or professional. High-quality sound reproduction enthusiasts will make for the Audio Hall, where they may expect to find new pick-ups of phenomenally light construction and tape recorders with yet wider frequency range and extended playing time. Stereo, after its somewhat strident introduction last year, has now settled into its rightful place as an important but not the only contributory element in the

search for a system of realistic sound reproduction.

One of the most valuable aspects of the Show is the opportunity which it affords of a glimpse behind the scenes of the sources of broadcast entertainment, to acquaint or remind us of the scale and complexity of the vast fabric of transmission and studio production necessary to put the shortest camera shot on our screens or the briefest news item on our loudspeakers. This is too often taken for granted, as are the lengthy processes of evolving new receiver designs and getting them into quantity production.

The "sideshows" as they are somewhat unkindly referred to by those engaged in the mainstream of the industry, also play an important part. The Services, both civil and military, give us an insight into those aspects of their work which increasingly involve electronics and communications and which they hope will attract the up-and-coming younger generation whose first interest in such things was perhaps stimulated by tinkering with a simple home-built receiver. We particularly commend the enterprise of B.R.E.M.A. and the R.T.R.A. in staging an exhibit to show the public the why and how of radio and television receiver servicing and to attract the best technical talent to a challenging and important career.

The Radio Show has served for nearly forty years as the focal point of the radio industry where potential customers can see under one roof the choice available to them, where manufacturers and their dealers can do business and where those interested in technical development can take stock, conveniently and at first hand, of the march of events. The Show will lose much of its value if it is not comprehensive and we view with misgiving the decision of one of the large firms, Pye, to hold a separate exhibition this year outside Earls Court. It may be true, as they say, that the Radio Show offers limited scope for a sufficiently comprehensive display of the Group's diverse activities, but that could equally well be said of A.E.I. and many other great firms who are nevertheless content to support the Show and to let us see those sections of their interests which impinge on broadcast entertainment. We hope that any unusual circumstances which may have influenced Pye's decision this year may be circumvented and that next year we shall be sure of finding all the important firms, both great and small, once again under the same roof.

# Transistor V.H.F./F.M. Receiver

By R. V. HARVEY\*, B.Sc., A.M.I.E.E.

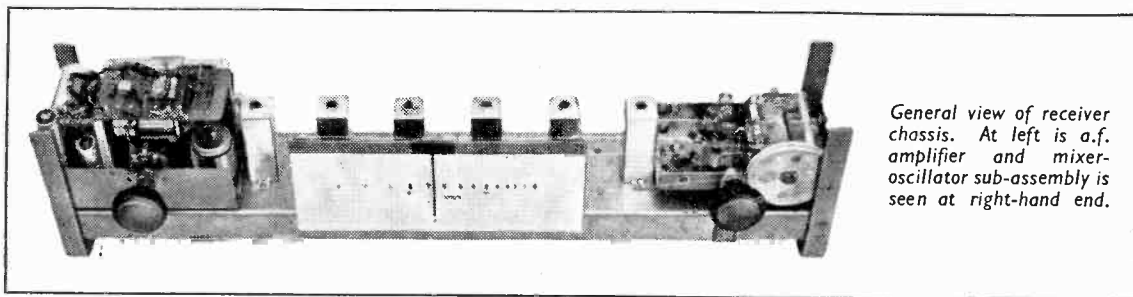

## 2. Construction and Alignment

**A** GENERAL view of the receiver chassis is shown in the photograph. The i.f. amplifier occupies about 11 inches along the centre of a brass channel  $20 \times 3 \times 1$  in; the r.f. and a.f. circuits are housed in separate units at each end. The left-hand knob is the on-off/a.f.-gain control; the right-hand knob controls the tuning and is coupled to the scale pointer by a cord drive using flying pulleys to obtain the expanded tuning scale as shown in Fig. 2; this layout is convenient for the size of cabinet chosen but these units could be disposed in a more compact form if desired, provided that no liberties are taken with the circuit layout. In particular, the i.f. unit has a maximum gain of 90 dB and is unscreened; any reduction in the spacing of two inches per stage would necessitate some additional screening.

**R.F. Unit.**—Fig. 3 shows the layout of the r.f. circuits. The unit chassis measures  $4\frac{1}{2} \times 2\frac{1}{2} \times \frac{3}{8}$  in and is supported  $\frac{3}{8}$  in above the main chassis by four brass pillars; this gives sufficient clearance for the  $2\frac{1}{8}$ -in diameter tuning-drive drum. The tuning coils are wound with the earthy ends uppermost to enable the coupling coils to be added subsequently. The r.f. input coil is wound in a left-hand sense for convenience, and the earth return for the coil and input capacitor is a tag on the input socket. The oscillator transistor is placed close to the tuning capacitor with its base lead adjacent to the oscillator coil, to which it is tapped at the first turn via a 3000-pF ceramic-disc capacitor. The tag on the frame of the tuning capacitor is used as the earth

connection for the oscillator coil, the internal screen of the transistor and the collector-decoupling capacitor. A feed-through capacitor in the centre of the chassis supplies the collector and base circuits; the base-feed choke is detailed in the coil winding data.

The i.f. output tags project through holes in the main chassis and are connected directly to the i.f. input coil and the only earth point for the whole mixer is between the tags. The circuit diagram, Fig. 1, shows an extra pair of capacitors and a centre-tapped choke between the oscillator coupling coils and the mixer diode. This latter circuit may be added at a later stage if required but normally it will not be necessary and it has therefore been omitted from the layout. The tuning-capacitor swing is restricted to  $150^\circ$  by two diametrically-opposed studs,  $\frac{3}{8}$  in in diameter, fixed to the tuning drum, which engage with a similar stud projecting from the frame bar of the capacitor.

The r.f. unit has a screening cover. This may be omitted if the wiring is kept close to the chassis but there will then be an increase in both oscillator radiation and i.f. break-through. To prevent microphony due to movement of the oscillator circuit, a liberal application of polystyrene cement to the coils and the mixer crystals is recommended, and the transistor should be fixed to the chassis with a suitable adhesive. The coaxial input socket is connected to a socket at the rear of the cabinet by a coaxial lead; an internal dipole, made by splitting

\*B.B.C. Research Department.

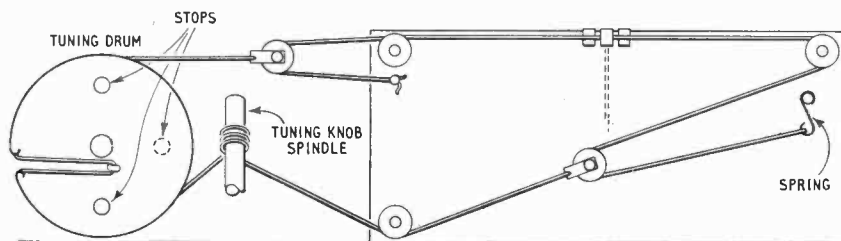

Fig. 2. Arrangement of tuning drive and dial with jockey pulleys to double scale length.

back some twin flex for about two feet and pinning it round the inside of the cabinet back, may be plugged in if desired.

**I. F. Unit.**—Starting as close as possible to the r.f. unit, the brass channel is drilled for the six coil formers at 2-in spacing between centres. Following each coil a tag-board,  $1 \times 2\frac{1}{2} \times \frac{1}{16}$  in, should be mounted under the chassis. The six tag-boards are fixed on  $\frac{1}{4}$  in spacers, and each carries six small turret terminals. The first four tagboards carry the four i.f. transistors; the last two carry the limiter, discriminator and first a.f.-stage circuitry. Fig. 4 shows the layout of the first two i.f. stages and Fig. 5 shows the limiter and discriminator. At the end of the i.f. chassis there is a four-pin plug which engages with a socket on the a.f. unit. The pin connections used are:—

1. A.F. output to gain control via C<sub>52</sub>.
2. Supply for oscillator from Zener diode.
3. Supply for i.f. amplifier.
4. Used as soldering tag for the Zener diode circuit which is mounted on the i.f. chassis for convenience. The earth connection between the two chassis is completed by bolting them together.

**A. F. Unit.**—The chassis measures  $5 \times 3 \times 1\frac{1}{2}$  in and carries a vertical brass partition 3-in square. The output transistors are bolted to this partition with mica plates and nylon screws which are supplied with

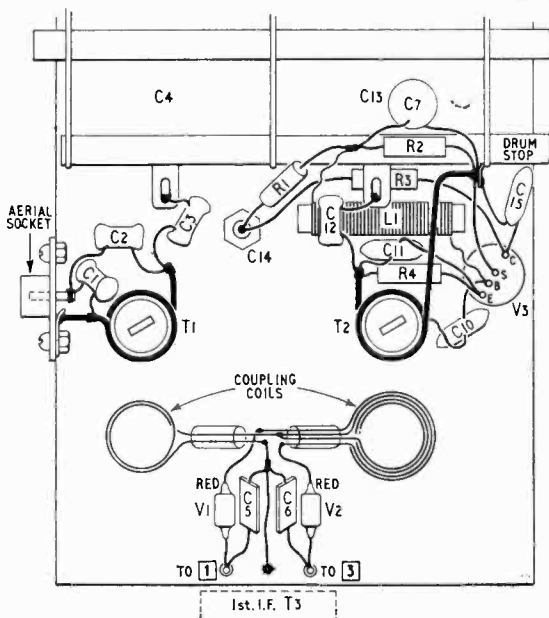

Fig. 3. Layout of r.f. unit. Coupling coils on T<sub>1</sub> and T<sub>2</sub> are shown, for clarity, as if "lifted off" formers.

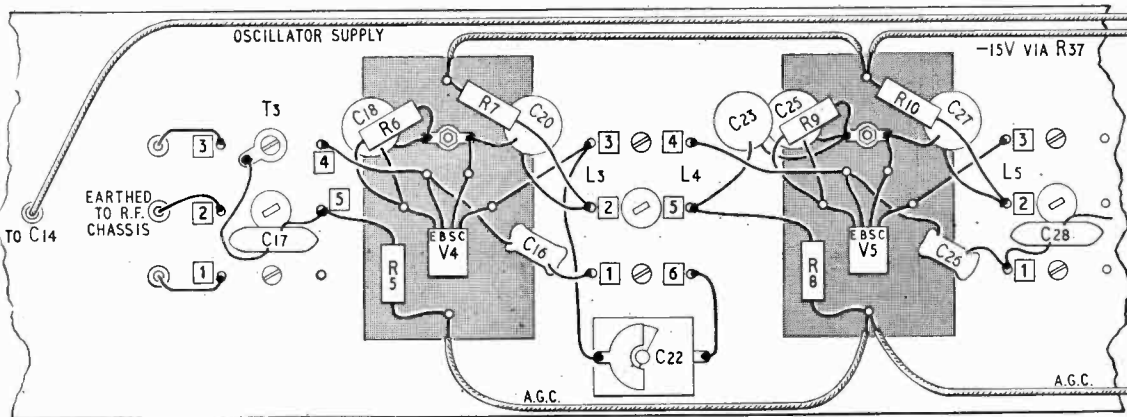

Fig. 4. First and second i.f. amplifier stages: wiring of the following stages is similar.

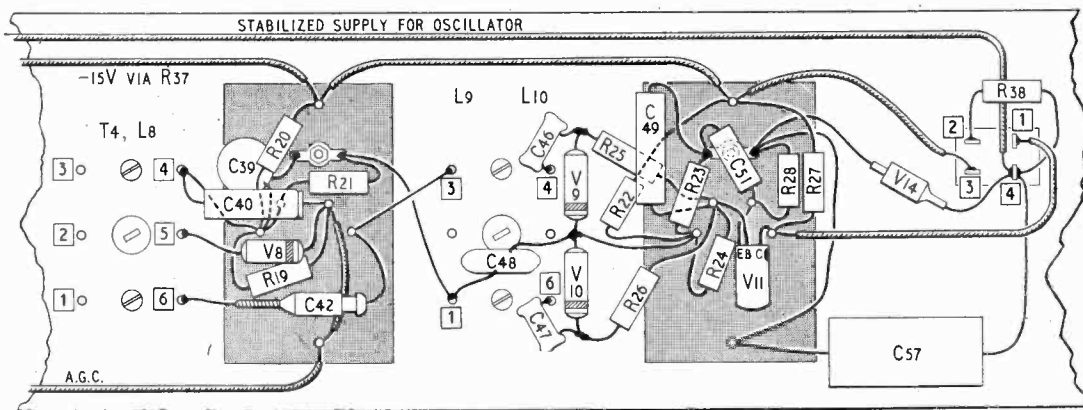

Fig. 5. Limiter, discriminator and first a.f. amplifier layout.

each matched pair of transistors. The power-input plug, loudspeaker socket and the fuse are mounted at the rear of the chassis. A power plug of a polarized type must be used to prevent accidental reversal of the supply; the recommended batteries each require a polarized plug and these should be made up in a power lead with a flying socket connector for the input to the set. An exact layout for this unit is not given as it is not vital to the performance and is determined mainly by the dimensions of the capacitors used.

## Alignment

Before switching on for the first time, it is advisable to check that the polarity of the supply and of the electrolytic capacitors is correct. During alignment, any changes to the connections of the circuit should be performed either with the power removed or after careful consideration of the consequences (which may be swift, ominously silent and expensive!).

**A. F. Unit.**—Disconnect the feedback network,  $R_{34}C_{55}$ , from the a.f. output and connect it to earth. Disconnect  $C_{52}$  from the gain control.  $R_{39}$  and  $R_{41}$  must then be adjusted so that the quiescent current in the output transistors is between 5 and 10 mA. These currents are best measured by connecting a meter of 1000-ohms resistance across the one-ohm emitter resistors,  $R_{44}R_{45}$ , and adjusting for between 5 and 10  $\mu$ A.

Connect a tone source of 6.8-k $\Omega$  impedance to the "live" end of the gain control through an 8- $\mu$ F blocking capacitor, and an oscilloscope across a 15-ohm resistor in place of the loudspeaker. If the transformer secondary windings are correctly connected, an input e.m.f. of 70 mV r.m.s. should produce an output of 11 volts peak-to-peak and an increase of input above this should produce a symmetrical flattening of peaks. If there is noticeable cross-over distortion at low input levels, this may be minimized by a further adjustment to  $R_{39}$  and  $R_{41}$ . Reconnect the feedback network; if the transformer primary sense is correct the gain will fall by 16 to 18 dB.

**I. F. Amplifier and Discriminator.**—Disconnect the a.g.c. line from  $C_{40}$  and connect it to a potential divider consisting of 10 k $\Omega$  from the supply and 1.5 k $\Omega$  to chassis. Short-circuit  $L_8$ , replace  $C_{40}$  by a 100-pF capacitor and connect the junction of this and  $R_{19}$  to an oscilloscope via a 10-k $\Omega$  resistor. Connect a f.m. signal generator, using a 0.01- $\mu$ F isolating capacitor, to the collector of V5. Set  $C_{33}$  to half-capacitance and tune  $L_6$ ,  $L_7$  and  $T_4$  for maximum response at 10.7 Mc/s. Increase  $C_{33}$  in stages, adjusting  $L_6$  and  $L_7$  until the response curve is just over-coupled and adjustment of either  $L_6$  or  $L_7$  produces a tilt of the response symmetrical about the centre frequency. Transfer the signal generator connection to the base of V4, set  $C_{22}$  half way and tune  $L_3$ ,  $L_4$  and  $L_5$  for maximum at 10.7 Mc/s. Increase  $C_{22}$  in stages till the response shows 1-dB peaks at 10.7 Mc/s  $\pm$  60 kc/s, as shown in Fig. 6, and responds to adjustment of  $L_3$  and  $L_4$  by a symmetrical tilt. At each adjustment, vary the input level to ensure that the last i.f. stage, V7, is not over-loading. Replace  $C_{40}$ , insert a 1-mA meter in series with  $R_{19}$ , measure the response point by point and compare with Fig. 6.

To align the discriminator, transfer the oscilloscope to the a.f. output (top of  $C_{49}$ ). With the f.m. signal generator set to the centre of the i.f. pass-band, 10.7 Mc/s, and deviated  $\pm$ 200 kc/s, set  $C_{42}$  to half way and tune  $L_9$  and  $L_{10}$  to obtain a symmetrical response of the general shape of Fig. 7. Adjust the discriminator coupling in stages by moving  $L_9$  along the coil former until with further adjustments to  $L_9$  and  $L_{10}$ , the response is symmetrical and linear over  $\pm$ 120 kc/s. Insert a microammeter between  $R_{24}$  and  $R_{25}$  and, for constant current in  $R_{19}$ , measure the discriminator load current, point by point, over the frequency range  $\pm$ 200 kc/s and compare with Fig. 7.

**Limiter and Third-Harmonic Filter.**—Remove the short-circuit from the third-harmonic filter,  $L_8 C_{41}$ , and re-tune the limiter transformer,  $T_4$ , for a maximum current in  $R_{19}$ ; set the input level to make this current 200  $\mu$ A. Connect the oscilloscope via a 100-k $\Omega$  resistor to the junction of V9 and  $R_{25}$ . Apply 100% amplitude modulation to the signal and display the amplitude response of the limiter. The reader should refer to J. G. Spencer's article\* for curves showing limiter characteristics in various conditions.  $L_8$  must be adjusted to give a curve with a top as flat as possible, consistent with the knee of the curve occurring at a low value of instantaneous input. If the knee shows at less than 70% modulation or more than 80%, the discriminator coupling capacitor  $C_{42}$  should be decreased or increased accordingly. This last adjustment is a matter of compromise in that a greater absolute sensitivity can be obtained by increasing  $C_{42}$  at the expense of a lower a.m.-handling capacity by the limiter. The procedure for aligning the discriminator should be checked after completing the limiter and coupling adjustments; the a.g.c. line is then re-connected.

The above alignment may, if desired, be performed at an input frequency of 90 Mc/s after adjusting the r.f. circuits.

**R.F., Oscillator and Mixer Circuits.**—Break the earth connection between Pin 2 of  $T_3$  and chassis,

\**Wireless World*, Vol. 65, p. 493 (November 1959).

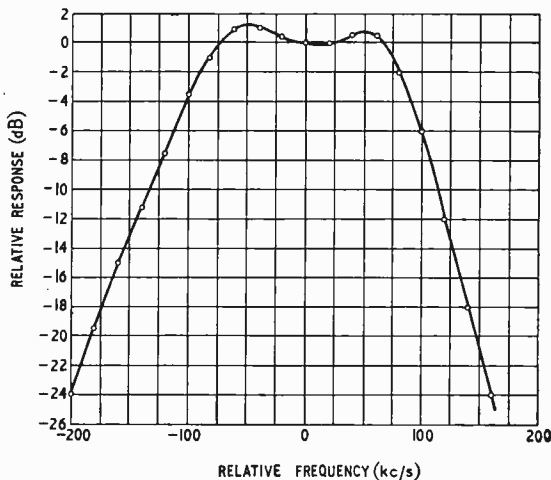

Fig. 6. Overall frequency response preceding limiter.

insert a 0.01- $\mu$ F disc capacitor and connect across it a 1-mA meter to measure the mixer current. Set the tuning capacitor to half-mesh, remove the dust core from  $T_1$  and set the core of  $T_2$  so that it protrudes  $\frac{1}{2}$  in from the top of the former. Adjust  $R_1$  to give maximum mixer current; this should be at least 150  $\mu$ A, at a collector current in V3 of about 1 mA. Insert the core into  $T_1$  from the top until a dip occurs in the mixer current reading, then unscrew the core three turns. Connect a f.m. signal generator to the aerial socket and set its output to 1 mV at 91 Mc/s. Adjust  $T_2$  core until the signal is heard and then set  $T_1$  for maximum limiter-load current. The tuning range should be adjusted in this way so that at 87 Mc/s the capacitor is at  $160^\circ$  and at 100 Mc/s it is at  $10^\circ$  from minimum capacitance.

### Resistors

The resistors used in the original receiver were 10%  $\frac{1}{4}$  W Erie Type 16, except  $R_{44}$ ,  $R_{45}$  and  $R_{46}$ .

R1*	56k $\Omega$	R15, 20,		R24, 29	8.2k $\Omega$
R2	2.2k $\Omega$	21, 27,	} 6.8k $\Omega$	R25, 26	100k $\Omega$
R3	100 $\Omega$	34		R28	1.2k $\Omega$
R4	150 $\Omega$	R16	5.6k $\Omega$	R32	390 $\Omega$
R5, 8, 31	3.3k $\Omega$	R17	1.5k $\Omega$	R35	47k $\Omega$
R6, 9, 13	4.7k $\Omega$	R18, 39*	} 560 $\Omega$	R37	47 $\Omega$
R7, 10, 14	1.8k $\Omega$	41*		R38, 46	680 $\Omega$
R11, 33	22k $\Omega$	R19, 22	10k $\Omega$	R40, 42	22 $\Omega$
R12	15k $\Omega$	R23, 30, 36	1k $\Omega$	R43	10 $\Omega$

\*Adjust on test, see alignment instructions.

The volume control is 5 k $\Omega$  log, or semilog, law potentiometer with switch. Resistors  $R_{44}$ ,  $R_{45}$  and  $R_{46}$  are one ohm in value and are made by winding a  $13\frac{1}{2}$ -in length of 26 s.w.g. insulated (double-cotton-covered) Eureka wire as a self-supporting coil.

### Fixed Capacitors

Many of the capacitors listed below were chosen not only for a particular value of capacitance but for other features such as temperature coefficient or size. If it is desired to use a component produced, for instance, by another manufacturer, a careful check should be made to ensure that all

C1	100 pF Erie N750/BD
C2, 16, 24,	} 6.8 pF Erie NPO/AD
29, 36	
C3, 12	18 pF Erie N750/AD
C5, 6	470 pF T.C.C. 101 SMP
C7, 10,	} 3000 pF Erie K7004/831
11, 15	
C8, 9	47 pF Erie NPO/AD
C14	4700 pF T.C.C. CTH315/LT
C17, 18, 20,	} 0.01 $\mu$ F Erie K7004/811
23, 25, 27,	
28, 30, 32,	
35, 37, 38,	
39, 48	

C19, 21,	} 330 pF T.C.C. 101 SMP
31, 34	
C26	68 pF T.C.C. 101 SMP
C40	8 $\mu$ F 15V electrolytic, T.C.C. CE67B
C41	3.3 pF Erie NPO/AD
C43, 44, 45	120 pF T.C.C. 101 SMP
C46, 47	27 pF
C49*	0.01 $\mu$ F
C50, 57, 60	1000 $\mu$ F 25V electrolytic
C51	100 $\mu$ F 6V electrolytic

C52	8 $\mu$ F 15V electrolytic
C53, 56	1000 $\mu$ F 6V electrolytic
C54	4 $\mu$ F 12V electrolytic
C55	820 pF mica
C58	0.25 $\mu$ F paper
C59	500 $\mu$ F 12V electrolytic

\* The value (0.003 $\mu$ F) given for C49 in Fig. 1 (August issue) gives a de-emphasis time constant of about 15 $\mu$ sec (not 30 $\mu$ sec as stated) for treble boost. For 50 $\mu$ sec de-emphasis (flat electrical response) C49 should be 0.01 $\mu$ F. References to 1,200pF for C49 in both the caption to Fig. 1 and p. 369 should be deleted.

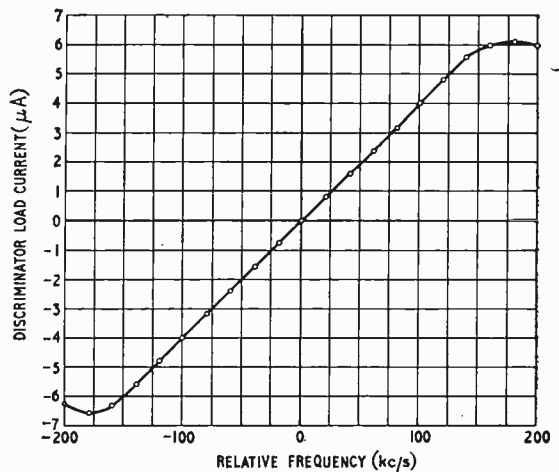

Fig. 7. Discriminator response for a signal giving a constant voltage at the limiter.

important characteristics are the same as those of the specified component.

### Variable Capacitors

As with some of the fixed capacitors, special characteristics may have influenced the choice of the variable capacitors specified.

- C4, 13 Tuning capacitor. Wingrove and Rogers, Type C28-142, 9/0.045in. 7 to 18 pF per section. Restricted to  $150^\circ$  swing by stops on drum.
- C22, 33 I.F. coupling. Wingrove and Rogers Type C32-01, 10/0.0075in. 2 to 11 pF.
- C42 Discriminator coupling. Wingrove and Rogers Type S50-01/2. 0.7 to 4 pF.

### Coil Data

Unless otherwise stated, the wire used for winding is enamel insulated. Numbers in brackets indicate the connections shown on the circuit diagram given last month (Fig. 1) and correspond with the numbers given on the coil formers. Where capacitors are mentioned, they should be fitted inside the screening can.

**R.F. and Oscillator** Former: Neosid 3500, Bakelite, 7 mm outside diameter (o.d.)  
Core: Neosid 901, 6 × 12 mm.

R.F.: T1 6 turns 20 s.w.g. tinned-copper (t.c.) wire spaced to occupy 0.4in.  
Coupling coil; 2 turns 36 s.w.g. interwound with last turn at earthy end.

Oscillator: T2 8 turns 20 s.w.g. t.c. spaced to occupy 0.6in.  
Coupling coil; 2 turns bifilar 36 s.w.g. connected as 4 turns with centre tap and interwound with last turn at earthy end. Base tapping one turn from emitter end of winding.

Bias Choke: L1 110 turns 40 s.w.g. close wound on  $\frac{3}{16}$  in o.d. paxolin tube or rod, with 20 s.w.g. t.c. end wires  $\frac{1}{8}$  in apart.

Mixer Choke (optional) L2 40 turns 38 s.w.g. centre-tapped (c.t.) on Neosid CH2 dust core.

**I.F. Amplifier** Former: Neosid 5000 B/6E (7.6 mm o.d.)  
Top: Neosid 5001/6E.  
Can: Neosid DTV/1.  
Core: Neosid 900, 6 × 1 × 12 mm.

Input: T3 Primary; 5 turns bifilar 22 s.w.g. close wound, connected as 10 turns (1, 3) with c.t. (2).  
Insulation; 2 turns cellulose tape.  
Secondary; 7 turns (4, 5) 22 s.w.g. close wound centrally over primary.

Second i.f.: L3 Primary at top, 12 turns 22 s.w.g. (1, 3) tapped (2) at 3 turns from (1).  
Coil spaced to occupy  $\frac{1}{2}$  in. Capacitor, C19, across coil, 330 pF silvered mica.  
Spacing between coils  $\frac{1}{8}$  in.  
L4 Secondary 12 turns 22 s.w.g. (4, 6) tapped (5) at 3 turns from (4).  
Coil spaced to occupy  $\frac{1}{2}$  in. C21 across coil, 330 pF silvered mica.

Third i.f.: L5 24 turns 28 s.w.g. (1, 3) close wound tapped (2) at 6 turns from (1).  
C26 across coil, 68 pF silvered mica.

Fourth i.f.: L6, L7 As second i.f. L3, L4 respectively, (capacitor numbers C31 C34).

Limiter: T4 Primary at top starting (1)  $\frac{1}{8}$  in below top plate, 32 turns 38 s.w.g. (1, 3) tapped (2) at 8 turns from (1).  
Secondary; 72 turns 38 s.w.g. (4, 6)  
Wound as single layer solenoid with 24 turns of primary (2, 3) interwound with first 24 turns of secondary starting at (4).

Third-harmonic filter: L8 25 turns 38 s.w.g. close wound (5, 6) finishing (5)  $\frac{1}{4}$  in from base of same former as limiter T4. C41 across coil, 3.3 pF.

Discriminator: L9 Primary at top, starting at (3) wound on one layer of cellulose tape, sticky side out, to allow adjustment, 15 turns 30 s.w.g. spaced 1 : 1 (1, 3). C43 across coil, 120 pF silvered mica.  
Spacing between coils about  $\frac{1}{8}$  in.  
L10 Secondary 20 turns 30 s.w.g. close wound (4, 6).  
Two capacitors, C44, C45 (3, 4) and (3, 6) 120 pF silvered mica.

### A.F. Driver Transformer

Core: T5  $\frac{3}{4}$  in stack of 0.015in. Type 158 Mumetal\* laminations. Fully interleaved, butt joint in centre limb.

Primary: 1200 turns 38 s.w.g. in two sections of 600 turns each side of secondary winding (7, 9).

Secondary: 2 windings, 300 turns 34 s.w.g., wound bifilar (1 and 4, 2 and 5).

Satisfactory results can be obtained with a Gilson Type WO929/6 transformer, but there may be a 1 to 2 dB loss in feedback and power output.

### Transistors and Diodes

V1, 2	GEX66	G.E.C.
V3	2N247	R.C.A.
V4, 5, 6, 7	OC170	Mullard
V8	OA86	Mullard
V9, 10	OA81	Mullard
V11	OC75	Mullard
V12	OC71	Mullard
V13	V10/30A	Newmarket
V14	Z2A110	S.T.C.
V15, 16	GET115	G.E.C.

### Batteries

Two Ever-Ready Type AD39 or equivalent (7.5V each, series connected).

*To be concluded.* (Part 1, dealing with design considerations and giving the theoretical circuit diagram, was published in the August issue of *Wireless World*).

\*Telcon Metals Ltd., Manor Royal, Crawley, Sussex.

## Aluminium in Telecommunications

TWENTY of the thirty pages in the latest edition of the *Aluminium Courier* (No. 49), published quarterly by the Aluminium Development Association, are devoted to a review of the "ever-widening range of applications" of aluminium in telecommunication engineering. The review covers cables, waveguides, aerials and towers, radar scanners, components and the aluminizing of c.r. tubes. The *Aluminium Courier* is obtainable from the A.D.A., 33, Grosvenor Street, London, W.1, price 2s 6d.

# Medical Electronics at Olympia

THIRD INTERNATIONAL CONFERENCE AND ASSOCIATED EXHIBITION

ONE of the main objects of organizing conferences, exhibitions and other media of communication in medical electronics has been to bring together medical men and electronics engineers into a partnership from which both sides could benefit by an exchange of ideas. So far this cosy situation has not materialized. In spite of three conferences, two exhibitions and the formation of an international body, the medical profession has failed to co-operate and the communication is still all one way.

Whether this is because of conservatism, fear of being "blinded by science," or just professional snobbery on the part of the doctors, the tactics of the electronics people have clearly not been very successful. The Third International Conference and associated exhibition, held at Olympia in July, was, therefore, like the two previous events, largely a means of preaching to the converted. It served a useful purpose in bringing together the limited number of specialists in medical electronics—whether engineers or doctors—but did not reach the larger audience that was hoped for.

A noticeable technical trend in the medical electronics apparatus on view was, as might be expected, the wide use of transistors. In hospitals it is particularly important that instruments like electrocardiographs and stimulators should be as small and light as possible, for they have to be moved from department to department very quickly, and in operating theatres in particular there is a limit on the space available for them. A transistorized electrocardiograph which was particularly noticeable for its small size, clean lines and elegant appearance was shown by the Tokyo Sibaura Electric Company of Japan, where medical electronics is a highly-organized sphere of activity.

Apart from reducing the size of existing types of apparatus, transistors have made possible new instruments which could not have been developed before.

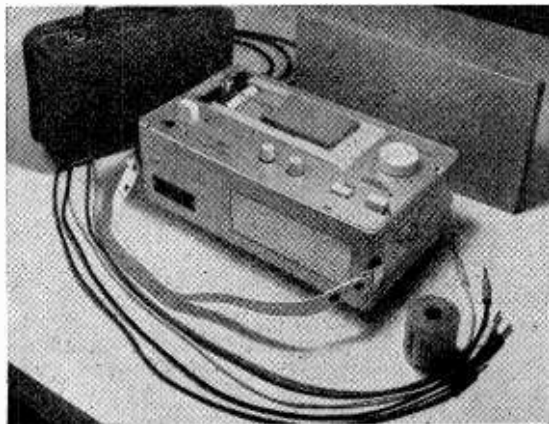

Compact transistorized electrocardiograph (Tokyo Sibaura Electric)

One example was the implantable pacemaker for the heart shown by Sierex Ltd. This device, originally developed by Elmgrist of Sweden, is a tiny transistor stimulator, encased in plastic which is implanted inside the body with its output electrode, on the end of a flexible lead, sewn on to the heart. The transistor circuit supplies pulses of 2msec duration and 2V amplitude at the normal heart rate of about 70 per minute. It is energized by a sealed nickel-cadmium battery which is charged at intervals by an electromagnetic induction system using a coil



Electronic pacemaker for the heart (Sierex)

carrying 10kc/s a.c., outside the body and a small coil and rectifier inside the pacemaker.

Another small transistor device for internal operation, is, of course, the "radio pill" or telemetry transmitter which has now been widely reported. Production models of these tiny transmitters were on view. They are used mostly for measuring pressures in the gastro-intestinal tract (in the range 0-3lb/sq. in.) but later models are being developed to measure temperature and pH values. An experimental "pill" for measuring pH, shown by the Medical Research Council, is designed so that the whole case acts as a voltaic cell when immersed in the fluid inside the alimentary canal. The varying voltage derived from this is applied to a back-biased silicon junction diode so that its capacitance is varied, and the alterations in capacitance are then used to modulate the frequency of the transistor oscillator.

In a paper by Farrar, Zworykin and Berkley a new type of radio pill was described in which the size was reduced and the limitation on operating life (due to the battery) was eliminated by using a system of energization from outside the body. As with the implantable pacemaker, electromagnetic induction is used but there is no battery to be charged in the "pill." Short bursts of 400kc/s energy are sent into the "pill" at 3,000 per second. These cause a tuned circuit to ring, and it does so in the intervals between bursts, not at 400kc/s, but



at its own resonant frequency, which is determined by a capacitance transducer measuring pressure in the alimentary canal. The energizing coil is also used for picking up these responses, and in the f.m. receiver used for detection an electronic gating system separates them from the energizing bursts.

Another tiny device for measuring pressures internally was really a probe—a micromanometer, shown by Telco of France, mounted on a catheter

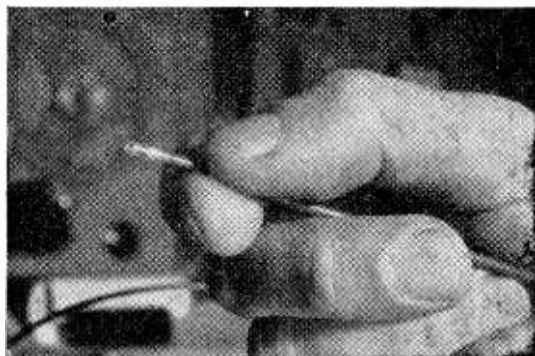

*Micromanometer probe transducer (Telco)*

for passing along a blood vessel into the heart. Measuring only 2.7mm in diameter and 7mm long, the micromanometer has a transducer consisting of a magnetic core fixed between two thin diaphragms. This moves axially with pressure changes and produces corresponding inductance changes in a coil. These changes are measured by a frequency modulation system. The pressure range of the device is  $\pm 300$ mm of mercury and as the frequency response extends to 5kc/s, the manometer can also be used as an intracardiac phonocardiograph for making a record of the sounds associated with heart action.

The use of an intracardiac phonocardiograph for locating precisely the source of murmurs and other defects of the heart was described in a paper by Wallace, Lewis, Dietz and Brown. In this case, however, the instrument was based on a barium titanate transducer and had a response up to 10kc/s.

Another paper concerned with cardiac instrumentation by L. J. Ryan described a miniature, self-contained cardiometer for recording the heartbeats of patients while they move about. Looking rather like a hearing-aid, it contains a four-stage transistor amplifier for amplifying the electrical potentials from the heart and the counting is done by a wristwatch movement through electromagnetic actuation of the escapement mechanism. Incidentally this device was developed on a voluntary spare-time basis by a group of American engineers called S.A.V.E. (Service Activities of Volunteer Engineers).

Turning to the circulation system itself, Winston Electronics showed an equipment for continuously recording a patient's blood pressure over long periods of time. In this follower system, the arterial pulsation from a finger or toe is picked up by a piezoelectrical crystal. The pulsation signal is used to open an air-valve which inflates a cuff from a small pump. This cuff starts to occlude the artery and when the occlusion is complete the air valve closes. A leak then allows the cuff to deflate until arterial pulsations reappear and once again the pump starts to inflate the cuff. The cuff pressure needed to

occlude the finger artery is only a few millimetres of mercury above the arterial pressure. Indication of the measured pressure is given on a dial and on a pen recorder.

For measuring the rate of flow of blood in the circulatory system it is normally necessary to puncture the blood vessels in some way. In the electromagnetic flowmeter, for example, the blood moving through a magnetic field generates a small voltage across a section of the artery, and this has to be picked up by inserting electrodes. A technique which requires no such connections to the patient was described in a paper by J. R. Singer. It is based on nuclear magnetic resonance and makes the measurements through the agency of radio frequency and steady magnetic fields. The application of the r.f. field in a short burst, locally through a coil, causes the magnetic movements of the nuclei of the blood atoms to change their orientation rapidly back and forth with respect to the steady magnetic field. This produces a kind of "tracer" condition in the bloodstream which persists for about 0.4 second. At a known distance along the blood vessel from the point of application of the r.f. field the arrival of the "tracer" is detected, and from the measured time between these two events the blood flow can be determined. The detection is based on the fact that the nuclei in the "tracer" condition do not absorb as much r.f. energy as they do in their normal condition, and this is shown up by an auxiliary r.f. oscillator and a receiver. Time interval measurement is done on the time base of a c.r.o.

In the field of ultrasonics, great interest was shown in C. N. Smyth's ultrasonic camera for internal examination. This device, which was described fully in our August 1958 issue\* converts a pattern of 4Mc/s ultrasonic energy (produced by the absorption pattern of the object under examination) into a television-type picture by means of a piezoelectric quartz disc acting as the target in a television pick-up

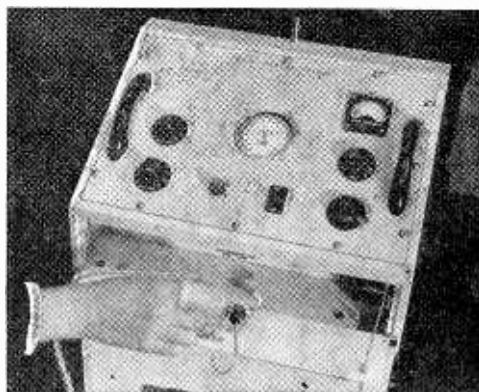

*Automatic blood-pressure follower for continuous recording (Winston Electronics)*

tube. Another ultrasonic examination system shown by the Western Infirmary, Glasgow, used echosounding principles and slow-mechanical scanning to build up a picture from responses displayed on a cathode-ray tube.

Ultrasonic reflections were also used in a simple apparatus, described in a paper by two Japanese

\* "Medical Electronics Conference." *Wireless World*, August 1958, p. 361.



authors, S. Satomura and Z. Kaneko, for examining the condition of the blood vessels and the patterns of flow in them. It consisted of an ultrasonic transducer energized for transmitting by a 5Mc/s oscillator and with a receiver and recorder for detecting and displaying the echoes. In the blood vessel, turbulences or fluctuations in the flow produce a kind of noise in the reflected ultrasonic signal due to complex interactions of waves on the Doppler principle. Since the turbulences are proportional to the rate of blood flow, the intensity of the noise in the reflected ultrasonic signal gives an indication of this rate of flow. So do the frequencies in the noise, which get higher with increasing rates of flow.

Summing up the conference which was organized by the I.E.E. in association with the International Federation for Medical Electronics, it could certainly be put down as a success. It drew about 150 contributions and about 800 delegates from all parts of the world. The exhibition, too, was very international in character, as a good 50 per cent of the exhibitors came from overseas. Although the commercial section of the exhibition was very well laid out, it was a pity that the stands devoted to research and hospitals were crammed into an inadequate area

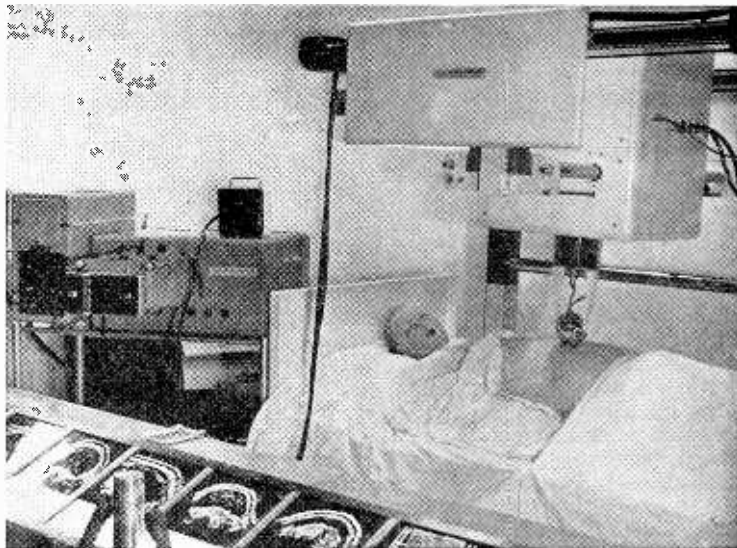

Ultrasonic scanning system (Western Infirmary, Glasgow)

with narrow alleyways, hidden behind the escalators, like the slum quarters of a town. However, the scene here was greatly enlivened by the general air of informality, and the notice which said "Both of these demonstrations are pretty crude, but we only thought of the circuit last week" revived the pioneering spirit and cocked a healthy and corrective snook at the rather bland atmosphere of salesmanship that hung over the rest of the exhibition.

## BOOKS RECEIVED

**Basic Electronics**, by Bernard Grob. Vol. 1 follows the order of topics presented in the first term's work of the technicians' training course at RCA Institutes, starting with elementary electricity and magnetism and ending with a brief insight into valves, transistors and radio frequency losses. It is to be followed by a second volume on Applied Electronics. Pp. 524; Figs. 383. Price 50s 6d. McGraw-Hill Publishing Co., Ltd., 95, Farringdon Street, London, E.C.4.

**Proceedings of the National Electronics Conference, 1958 (Vol. 4)**. Illustrated record (99 papers) of the annual conference held at Hotel Sherman, Chicago, Illinois, covering all aspects of radio and electronics from antennas to automatic navigation and from audio to computers. Pp. 1074, profusely illustrated. Price £7.50. National Electronics Conference, Inc. 228, N. La Salle Street, Chicago 1, Illinois, U.S.A.

**A Quality-Checking Receiver for V.H.F./F.M. Sound Broadcasting**, by C. G. Mayo, M.A., B.Sc., M.I.E.E., B.B.C. Engineering Division Monograph No. 25, gives circuit diagrams and performance details of two alternative prototype receivers, designed, without compromise to give a high standard of performance. Pp. 15; Figs. 13. Price 5s. B.B.C. Publications, 35, Marylebone High Street, London, W.1.

**Testing of Screened Enclosures**, by J. Miedzinski, B.Sc., A.M.I.E.E. Methods of measuring insertion loss and its dependence on the details of experimental arrangements as well as on frequency and the construction of the enclosure. Pp. 27; Figs. 19. Price 24s.

The British Electrical and Allied Industries Research Association, Thorncroft Manor, Dorking Road, Leatherhead, Surrey.

**Insulation for Small Transformers**, by J. H. Mason and C. G. Garton. Handbook for designers reviewing the factors influencing electric strength and life of insulation, methods of non-destructive testing and data on new materials. Pp. 93; Figs. 33. Price 37s 6d. The British Electrical and Allied Industries Research Association, Thorncroft Manor, Dorking Road, Leatherhead, Surrey.

### OCTOBER ISSUE

In addition to a varied selection of technical articles and the usual coverage of news from all quarters, our next issue, on sale on September 26th, will include the following special features.

**Radio Show Review.**—An assessment of trends in the design of sound and television receivers, as portrayed at the Earls Court Show.

**S.B.A.C.**—Developments in the field of aeronautical radio and electronics exemplified by manufacturers' displays at the static exhibition at the Farnborough Air Show (September 5th–11th).

# Converting to Stereo

## JOINING TWO MONO AMPLIFIERS

**S**UPERFICIALLY there would seem to be little more in setting up a stereo amplifier system than is implied in the sub-title above. But there can be snags and it may be worth while to consider the minor troubles which can arise, their cause and cure.

The usual general methods of layout should, of course, still be followed, with the addition that considerable care must be taken to avoid coupling between the two amplifiers. This care is necessary since, for a given degree of coupling, the crosstalk produced in the stereo case is much more serious than the level change produced in the corresponding mono case—3dB crosstalk is much more serious than 3dB level change. Such coupling can arise via stray capacities or common earth or h.t. wiring. As in the corresponding mono case with level changes, common earth or h.t. wiring is likely to be a much less serious source of crosstalk than stray capacities. To reduce stray-capacity crosstalk it may well be worth separating the two amplifiers by an earthed metal screen. The effects of any stray capacities can, of course, be reduced by decreasing the circuit impedances connected to these capacities.

### Additional Layout Problems

Earth wiring can also, of course, form hum loops. Working out an arrangement of earth connections which avoids hum loops is likely to be more difficult in stereo since one is often committed in advance to a number of earth points which are common to both amplifiers. Examples of such earth points are the common terminal of the stereo pick-up when this is a three- rather than a four-terminal device, on the balance control when this consists of a single potentiometer with its slider earthed and one arm in each amplifier, and in a common power supply.

The desirability of mechanically ganging certain of the controls, for example, the volume, bass and steep-cut controls, also imposes some restrictions on possible layouts for the two amplifiers. It may be advantageous not to gang the treble controls so that one can still make some allowance for any difference between the two loudspeakers or their acoustic surroundings—such differences are likely to be most pronounced at high frequencies.

It will naturally often be convenient to use a single common power supply. The current ratings required for the rectifier and smoothing choke are then, of course, the sum of those for the two amplifiers, and for this reason a larger rectifier than is required for each separate amplifier will often be needed. Where the voltages required by the two amplifiers are different, a single power supply would obviously have to deliver the greater of these voltages, suitable arrangements being made to drop this voltage for the low-voltage amplifier. As we have already seen, crosstalk due to signal currents coupling in common h.t. wiring will be more serious in stereo than the corresponding level changes in mono. Thus it may occasionally be necessary to increase the value of any smoothing capacitor common to both amplifiers.

Signal currents in the h.t. wiring can, of course, be very much reduced by using class-A push-pull output stages. To avoid common wiring and hum loops in earlier stages it will probably be convenient to use separate rather than common capacitors to smooth the h.t. for such stages.

Modifications to the circuits of the two amplifiers are only likely to be necessary to provide a balance control. It is desirable that, when the balance control is adjusted, the sum of the two amplifier power outputs should remain constant so that the volume level does not have to be simultaneously adjusted. If the total power output were to be allowed to vary too much, one might just as well use independently adjustable (i.e. ungangd) volume controls and dispense with a balance control. The required constant total power output can at least approximately be obtained by making the balance control in the form of a variable resistive divider gain control in each amplifier, the two gain controls being connected so that the gain of one amplifier is increased while that of the other is decreased as the balance control is adjusted. This general type of balance control is, in fact, almost universally used in practice. It is also desirable that the balance control should not produce more than about 6dB total gain variation in each channel, any greater difference between the two stereo channel sensitivities being taken up by preset adjustments. The maximum gain variations can, of course, be restricted by connecting a fixed resistor in series with the variable balance resistor in each circuit; a fixed resistance equal to the maximum variable resistor value gives a maximum variation of 6dB. Any loss in average gain due to the provision of a balance control must, of course, be allowed for.

### Practical Balance Controls

Most of the balance controls in use fall into one of two general types: the two variable resistors are either two separate but ganged potentiometers or, alternatively, the two arms of a single potentiometer with its slider earthed. The latter type is perhaps not so suitable for the experimenter, since he is then committed to a common earth point, and hum loops may be more difficult to avoid. Stray-capacity coupling between the two ends of the single potentiometer is also perhaps more likely.

Where two separate but ganged potentiometers are used, the sum of the two amplifier outputs normally varies by only 0.5dB when fixed series resistors are used to restrict the maximum gain variation in each channel to 6dB: the variation in total output increases to 3dB if the fixed resistors are decreased to zero so that the maximum gain variation is increased to infinity. The first value of 0.5dB variation in the total output is certainly quite acceptable, being below what can easily be heard.

When the two amplifiers have equal gains, they are obviously balanced when the variable balance resistances and consequently also the gain losses due

## S.B.A.C. EXHIBITORS

ABOUT a third of the exhibitors in the static exhibition at the Farnborough Air Show (September 5-11) are in, or closely associated with, the radio and electronics industry. The following list of manufacturers and research establishments has been selected from the list of nearly 300 exhibitors. A review of the developments in aeronautical radio and electronic equipment as seen at the exhibition, which is organized by the Society of British Aircraft Constructors at the Royal Aircraft Establishment, will be included in our next issue.

<p>A.E.I. Airmed Albright &amp; Wilson Amalgamated Wireless (Aust.) Amplivox Bakelite Bell Precision Engineering Belling &amp; Lea B.I. Callender's Cables Boulton Paul Aircraft Bristol Aircraft British Communications Corp. Brown, S. G. Bryans Aeroequipment Burgess Products Burndept Canadian Marconi Co. Cementation (Muffelite) Chelton (Electrostatics) Chloride Ciba (A.R.L.) Cole, E. K. Cossor, A. C. Cossor Radar &amp; Electronics Curran, John Decca Navigator Decca Radar de Havilland Propellers Ecco Electronics Elliott Brothers English Electric Ferranti Fibreglass Formica G.E.C. General Precision Systems Godfrey, Sir George Goodmans Graseby Instruments Grundy &amp; Partners Hawker Siddeley Hellermann Hendrey Relays Honeywell Controls Imhof Integral</p>	<p>K.L.G. Sparking Plugs Kelvin &amp; Hughes Lucas, Joseph M.L. Aviation Co. McMichael Marconi Instruments Marconi's W/T Marston Excelsior Microcell Ministry of Aviation Murphy Napier, D., &amp; Son Newmark, Louis Optical Measuring Tools Plannair Plessey Pullin Pye Redifon Rotax Royston Industries S.T.C. Salford Electrical Insts. Sanders, W. H. (Electronics) Sangamo Weston Savage, W. Bryan Short Brothers &amp; Harland Simmonds Aerocessories Smiths Aircraft Instruments Solartron Solus-Schall Southern Instruments Soerry Tealemit Technograph Electronic Prods. Thermionic Products Thorn Trix Ultra Electronics Vactric Venner W.S. Electronics Waymouth Gauges Western Manufacturing Westinghouse Whiteley Electrical Wireless Telephone Co.</p>
--	---

to the provision of a balance control are the same in each channel. It is convenient to assume this condition of equal amplifier sensitivities when quoting the gain loss due to the provision of a balance control. Usually the two variable balance resistors are equal when each is half its maximum value. In this case, the loss in gain due to the provision of a balance control is a factor of 1.3:1 when in addition series fixed resistors are used to restrict the maximum gain variation in each channel to 6dB, this loss increasing to 2:1 if the fixed resistors are decreased to zero so that the maximum gain variation is increased to infinity. As pointed out by Mullard, if one potentiometer is given an antilogarithmic law and the other a logarithmic law and is also wired in reverse, then the two variable balance resistors are equal in value when each is 0.9 of its maximum value. With such potentiometers then, the gain loss due to the provision of a balance control is reduced to a factor of 1.05:1 when series fixed resistors are used to restrict the maximum gain variation in each channel to 6dB, this loss increasing to 1.1:1 if the series fixed resistors are decreased to zero so that the maximum gain variation is increased to infinity. When such potentiometers are used the variation in the sum of the two amplifier outputs is somewhat different, being within 0.2dB of 1.9dB for any value of fixed series resistance from zero up to the maximum potentiometer value. Apart from this possibility there seems little to choose between linear and logarithmic potentiometers for the balance control.

Switches for reversing the phase of one channel or interchanging the two amplifiers relative to the loudspeakers are also sometimes provided for correcting errors in the connections between various units. However, since after any such correction the switches need never be further used, it would seem preferable to correct any connection errors directly, and thus avoid the capacity-coupling problems which are likely to arise on a switch connected to both amplifiers. Capacity coupling in such cases can be reduced by arranging for any stray capacities to occur in pairs whose junctions are connected via a relatively larger capacity to earth. Coupling either way is then attenuated by the capacitive dividers so formed.

## SHORT-WAVE CONDITIONS

Prediction for September

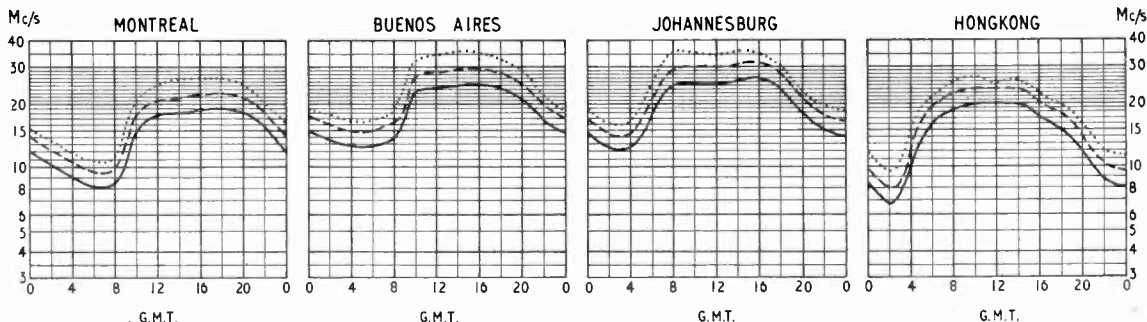

THE full-line curves indicate the highest frequencies likely to be usable at any time of the day or night for reliable communications over four long distance paths from this country during September.

Broken-line curves give the highest frequencies that will sustain a partial service throughout the same period.

..... FREQUENCY BELOW WHICH COMMUNICATION SHOULD BE POSSIBLE FOR 25% OF THE TOTAL TIME  
 - - - - - PREDICTED MEDIAN STANDARD MAXIMUM USABLE FREQUENCY  
 ——— FREQUENCY BELOW WHICH COMMUNICATION SHOULD BE POSSIBLE ON ALL UNDISTURBED DAYS

# WORLD OF WIRELESS

## West German "I.T.A."?

THE introduction of a second television network in West Germany has developed into a major political issue which may effect the introduction of a u.h.f. television service. There have been prolonged negotiations as to who should operate the second network, initially to consist of 29 u.h.f. transmitters due to be completed by the end of this year. At the end of July the German Chancellor announced the setting-up of a commercial television company—Deutschland Fernsehen—in which the Länder broadcasting organizations would be invited to join. For some time now, of course, there has been a limited number of commercial television programmes broadcast by the Länder organizations.

The Länder organizations have now asked the Government for permission to build a network of u.h.f. stations—some are already in operation experimentally. Our West German correspondent reports that no decision on the proposed u.h.f. networks is likely for some months, especially in view of next year's Government election.

## Space Research

MOST of the sixteen grants, totalling £184,540, recently made by the D.S.I.R. to universities for space research, are for projects associated with radio and electronics. The grants, made on the recommendation of the British National Committee on Space Research set up by the Royal Society, are for salaries of staff, travel and subsistence and development or purchase of special equipment.

The biggest award goes to Dr. R. L. F. Boyd, of the physics department of University College, London, who during the next three years is to receive £35,450 for rocket research in the upper atmosphere and a further £8,880 for the development and use of photoelectric satellite tracking equipment.

Dr. R. C. Jennison, of the Nuffield Radio Astronomy Laboratories, Jodrell Bank, is to have £30,297 over the next three-and-a-half years for low-frequency radio astronomy from an earth satellite and for microwave meteorite investigations from an earth satellite. Professor A. C. B. Lovell is to have £2,500 this year for the tracking of satellites and space probes. To enable Professor J. Sayers, of Birmingham University, to undertake electron and ion propulsion studies in the upper atmosphere and interplanetary space he is to receive £26,000.

Professor W. J. G. Beynon, University College of Wales, is granted £16,530 for a three-year study on the measurement of electron density/height profile with rockets using the Doppler method and the pulse method.

Three workers at Cavendish Laboratory have received grants: Dr. F. G. Smith is awarded £11,230 for a two-year research programme on the measurement of cosmic radio noise by receivers mounted on rockets and satellites; Professor M. Ryle, £2,678 for recording and interpretation of Doppler and Faraday effects in the radiations from artificial satellites; and Dr. K. G. Budden, £1,694 for studying the theory of propagation of radiations from artificial satellites.

Other awards include £13,006 to Professor E. A. Stewardson, physics department, Leicester University; £15,005 to Professor D. R. Bates, applied mathematics department, Queen's University, Belfast, £8,775 to Dr. H. E. Elliot and £7,935 to Dr. S. H. Hall, both of Imperial College, London and £4,560 to Dr. J. T. Houghton, of Clarendon Laboratory, Oxford.

**Jubilee Lectures.**—A limited number of free tickets are available for the first of the series of lectures being organized by Ultra to mark their 25th anniversary. It is being given at the Royal Festival Hall, London, at 6.30 on September 14th, when Professor Arthur Porter, of the University of Saskatchewan, will speak on the evolution of instrumentation. Applications for tickets should be sent to the Public Relations Officer, Ultra Electric, Western Avenue, London, W.3.

**Anglo-Japanese Trade.**—An increased quota of transistor sets is permitted to be imported from Japan during the 12 months ending 31st March next year under a new Anglo-Japanese trade agreement. The new figure is £200,000. The quota for sound radio and television sets (other than transistorized) is £100,000 and for radiograms and gramophones it is also £100,000.

**Wind-Powered Relay Station.**—Two wind generators with 30-ft diameter air screws are used to provide power for this microwave relay station on the Schöneberg in the Eifel mountains. The station forms part of the Frankfurt-Cologne radio link installed by the German Post Office originally for television but now used for a 60-channel pulse-modulated multiplex telephone service. The two generators together provide an overall output of 40kWhr/day. Photo. courtesy "NTZ," Brunswick.

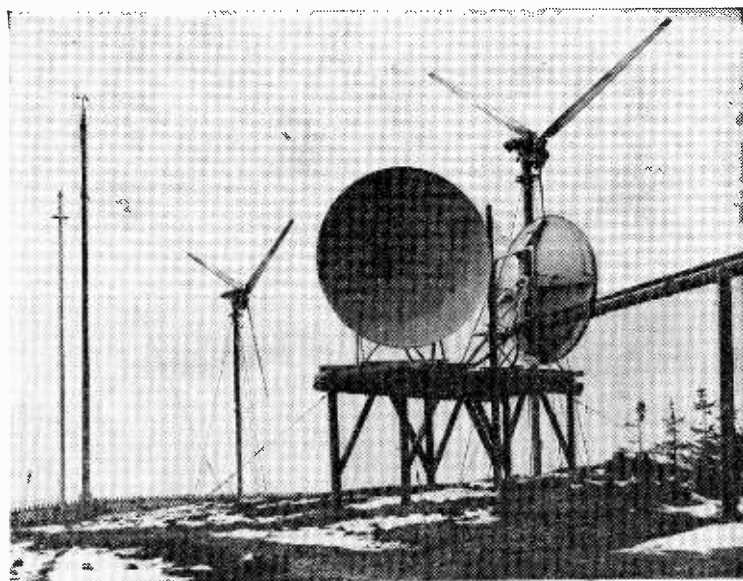

**Radio Industry Council.**—Lord Brabazon of Tara, who has been president of the R.I.C. since 1957, has agreed to serve for another year. In consequence of the sudden death of Air Marshal Sir Raymond Hart who had been full-time director of the R.I.C. since last year, R. Kelf-Cohen, C.B., has been appointed acting director until such time as a permanent appointment is made. He was under-secretary, Ministry of Fuel and Power, from 1946 to 1955. The 1960/61 representatives of the three constituent bodies forming the council are:—B.R.E.M.A., G. Darnley-Smith (Bush), F. W. Perks (British Radio Corp.), E. E. Rosen (Ultra), and A. L. Sutherland (Philips); B.V.A., S. S. Eriks (Mullard), F. V. Green (S.T.C.), G. A. Marriott (G.E.C.), and J. W. Ridgeway (A.E.I. Woolwich); and R.E.C.M.F., P. D. Canning (Plessey), Hector V. Slade (Garrard), K. G. Smith (N.S.F.) and Dr. G. A. V. Sowter (Telcon). E. E. Rosen is chairman and H. V. Slade vice-chairman.

**Goldup Memorial.**—An annual award, which will be known as the Goldup Prize, has been established by the I.E.E. for the best Higher National Certificate student who takes electronics or telecommunications subjects in his final examination. The prize has been endowed by Mullard Ltd., as a memorial to the life and work of the late T. E. Goldup, a director of the company and a past president of the Institution, who took a keen and extremely active interest in education.

**I.E.E. Council.**—The following have been elected to fill the vacancies which will occur on the council of the I.E.E. on September 30th:—Sir Hamish D. MacLaren (president); C. T. Melling and B. Donkin (vice-presidents); C. E. Strong (hon. treasurer); and D. A. Barron, F. H. S. Brown, Professor J. M. Meek, Dr. R. L. Smith-Rose, Dr. H. G. Taylor, J. C. Arkless and J. S. McCulloch ordinary members of the council.

**Electronics and Communications Section, I.E.E.**—The new chairman of the section is T. B. D. Terroni (A. T. & E.) and R. J. Halsey (G.P.O.) is a vice-chairman. The six vacancies among ordinary members of the committee have been filled by:—W. H. Aldous (G.E.C. Research Labs.), W. J. Perkins (National Institute for Medical Research), Dr. K. F. Sander (Cambridge University), Dr. J. A. Saxton (D.S.I.R.), T. R. Scott (Standard Telecommunications Laboratories) and F. J. D. Taylor (G.P.O.).

**B.E.A.M.A.** has set up a Semi-conductor Devices Section to "foster standardization of semi-conductor devices both on a national and international basis." The initial membership of the section, which it is stated "will co-operate closely with the Electronic Valve and Semi-conductor Manufacturers' Association" (V.A.S.C.A.) comprises:—A.E.I. (Rugby), A.E.I. (Woolwich), Electric Construction, English Electric, Ferranti, G.E.C., Hackbridge & Hewitt Electric, International Rectifier, Philips, S.T.C. and Westinghouse.

**Pye Show.**—The Pye group of companies are holding their own radio, television and electronics exhibition in the Royal Festival Hall, London, from August 22nd to 24th. The exhibition will cover not only the domestic sound radio and television side of the group's business but also industrial electronics, instruments, marine radio and also telephone equipment from "Temco" the newest member of the group. It will be open to the public from 11.0 to 9.0 on the first two days and from 3.0 to 9.0 on the last day.

**Cabinet Styling.**—B.R.E.M.A. is to hold its fourth "cabinet styling" exhibition in the Victoria Halls, Bloomsbury Square, London, W.C.1, on October 4th, 5th and 6th from 2.0 to 6.0. It is a trade show of embellishments, cabinet materials, fabrics, ornamental controls, "in-the-room" aerials, etc., and admission is by trade card.

**P. P. Eckersley** is giving a talk entitled "Radio from the beginning" at a meeting in the Ilford Town Hall, Essex, at 3.0 on October 9th. The meeting has been arranged by the East London Group of the R.S.G.B.

**Jodrell Bank.**—Manchester University's radio astronomy laboratories at Jodrell Bank have been renamed the Nuffield Radio Astronomy Laboratories. The Nuffield Foundation originally donated £200,000 towards the cost of the radio telescope at Jodrell Bank and has recently given a further £25,000 and Lord Nuffield personally another £25,000 in order to clear the deficit on the project.

**Sound propagation** in the atmosphere is the theme of a symposium to be held in the new physics building of Imperial College, South Kensington, on September 8th. It is being organized by the Acoustics Group of the Physical Society. Full details are available from Drs. G. G. Parfitt and R. W. B. Stephens, Imperial College, South Kensington, London, S.W.7.

**Amateur Television Convention.**—The fifth convention of the British Amateur Television Club is being held on September 10th in the Conway Hall, Red Lion Square, London, W.C.1. Further particulars and tickets (5s all day, 2s 6d after 2) are obtainable from D. W. E. Wheele, 56 Burlington Gardens, Chadwell Heath, Romford, Essex.

**Autumn Audio Fair Cancelled.**—Audio Fairs Ltd. have announced that the Audio Fair planned for October at Southport, Lancs, has been cancelled.

## MATTERS EDUCATIONAL

**Logical Circuits.**—A course of 12 lectures on the design of logical circuits, followed by an 11-week laboratory course, is being held on Friday afternoons from September 30th at the Borough Polytechnic, London, S.E.1. The fees are 25s and 20s respectively.

**Pulse Techniques.**—The Borough Polytechnic is also providing a 20-lecture course on pulse techniques on Monday evenings from October 3rd (fee £2 10s). Supplementary to this course is a 12-week laboratory course which runs concurrently with it on Monday afternoons or Thursday evenings (fee £1).

**Servicing Electronics.**—A course in preparation for the C. & G./R.T.E.B. new certificate in electronics servicing is offered by the Matthew Boulton Technical College, Suffolk Street, Birmingham, during the coming session. The college is also providing a new course for the C. & G. certificate in supplementary studies in telecommunications.

**Norwood T.C.**—Full-time technical courses listed in the 1960-61 prospectus from the Norwood Technical College, Knight's Hill, London, S.E.27, cover telecommunications engineering, marine radio operating and radar maintenance. There are also part-time day and evening courses in preparation for the C. & G. telecommunications engineering certificate, the C. & G./R.T.E.B. servicing certificate and a 2-year evening course on television technology.

**Radio Amateur Exam.**—We have been notified of the following classes of instruction (both radio theory and Morse) being held during the coming session in preparation for the Radio Amateur Examination:—

*Battersea Men's Institute*, Latchmere Road, Lavender Hill, London, S.W.11; Wednesdays.

*Holloway Evening Institute*, Montem School, Hornsey Road, London, N.7; Mondays, repeated on Tuesdays and Wednesdays.

*Ilford Luterary Institute*, High School for Girls, Cranbrook Road, Ilford; an eight-month course on Wednesdays with more on Mondays.

*Wembley Evening Institute*, Copland School, High Road, Wembley; Mondays.

*Bognor Regis Technical Institute*, Southway, Bognor Regis; Wednesdays and Fridays.

*Bradford Technical College*, Central Hall, Bradford, 5; Wednesdays.

*Glasgow*—Allan Glens School, Montrose Street; Tuesdays and Thursdays.

*Openshaw Technical College*, Whitworth Street, Manchester 11, classes for first and second year students.

# Personalities

Sir Willis Jackson, F.R.S., director of research and education of Associated Electrical Industries (Manchester) Ltd., is to return to academic life as professor of electrical engineering at Imperial College, University of London. Sir Willis resigned his chair at Imperial College some seven years ago to become director of research and education of Metropolitan-Vickers Electrical Co., now A.E.I. (Manchester).



Sir Willis Jackson.

Sir Leslie Gamage, chairman and managing director of the General Electric Co. since 1957, is to retire at the end of this year. He is relinquishing his executive duties as managing director immediately but will continue as chairman until December 31st. He joined the company in 1919 and was appointed vice-chairman and joint managing director in 1943.

Two British women engineers, Miss Lesley S. Souter, B.Sc., A.R.T.C., F.Phys. Soc., A.M.I.E.E., and Miss Rosina Winslade, M.S.I.T., have been awarded by the Caroline Haslett Memorial Trust "travelling exhibitions" to enable them to study the training, employment and prospects of women engineers in the U.S.S.R. Miss Souter, who studied electrical engineering at the Royal Technical College, Glasgow, obtained her B.Sc. degree from Glasgow University in 1940. She was in the research laboratories of the G.E.C. and Mullard before joining the A.E.I. Research Laboratory at Harlow, Essex, where she now leads the magnetic materials section. Miss Souter is vice-president of the Women's Engineering Society. Miss Winslade is senior sales engineer with Research and Control Instruments Ltd., where she is in charge of the industrial measuring and recording apparatus in the instrument group. She was for ten years with the Plessey Co., first as junior laboratory assistant and later working on the design and development of electronic test equipment. Miss Winslade was the first woman member of the Society of Instrument Technology.

P. E. F. A. West, M.A., A.M.I.E.E., has been appointed Regional Engineer, B.B.C. West Region, in succession to G. H. Daly, M.B.E., who joined the British Broadcasting Company in 1925 as a transmitter engineer at Savoy Hill, London. He has been regional engineer since 1955. Mr. West joined the Corporation in 1936. During the war he served in the Royal Navy, where he attained the rank of Lieutenant Commander. He returned to the B.B.C. Design and Installation Department in 1946 and two years later was transferred to the Overseas and Engineering Information Department. In 1951 he was appointed assistant to the Chief Engineer and since 1956 has been on the staff of the Senior Superintendent Engineer, External Broadcasting.

Air Vice-Marshal H. B. Wrigley, C.B.E., until recently Director of Guided Weapons Research and Development (Air) in the Ministry of Aviation, has been appointed senior technical staff officer at Fighter Command Headquarters. He was at one time Chief Signals Officer of the 2nd Tactical Air Force in Germany, and in 1954 was appointed Director of Signals in the Air Ministry.

F. A. Vick, O.B.E., Ph.D., becomes director of the Atomic Energy Research Establishment, Harwell, in succession to Sir Basil Schonland, C.B.E., F.R.S., on September 1st. Sir Basil, who was knighted in this year's Birthday Honours List, is to continue as director of the Atomic Energy Research Group of which A.E.R.E., Harwell, is a part. Born in South Africa in 1896 he became exhibitioner at Gonville and Caius College, Cambridge, and carried out research at the Cavendish Laboratory. He joined the staff at Capetown University in 1922 and in 1937 founded and took charge of the Bernard Price Institute for Geophysical Research at the University of Witwatersrand, Johannesburg. He was a brigadier in the South African Corps of Signals in the early days of the last war but from 1941 to 1944 was Superintendent of the Army Operational Research Group, Ministry of Supply. After the war he returned to South Africa but came back to the U.K. in 1954 as deputy director of Harwell. Dr. Vick, who is 49 and was educated at Birmingham University, was a lecturer in physics at University College, London, before he joined the Ministry of Supply in 1939 as assistant director of scientific research. In 1945 he returned to his academic work as lecturer in physics at Manchester University. From 1950 until his appointment last year as deputy director of Harwell, he was professor of physics at the University College of North Staffordshire. Dr. Vick was vice-president of the Institute of Physics from 1953 to 1956.



Dr. F. A. Vick.



Dr. R. L. Smith-Rose.

Dr. R. L. Smith-Rose, C.B.E., has been appointed by the Postmaster General as chairman of the Post Office Frequency Advisory Committee in succession to Sir Lawrence Bragg, O.B.E., F.R.S., who has resigned owing to his many other commitments. Dr. Smith-Rose retires in September from the directorship of the Radio Research Station of the D.S.I.R., which he has held since 1948. He has been a member of the Frequency Advisory Committee since it was set up under the chairmanship of Sir Lawrence Bragg in 1958. The other members of the committee are:— Granville Berry (city engineer and surveyor, Coventry); Sir Harold Bishop (B.B.C.); Capt. C. F. Booth (Post Office); J. R. Brinkley (Pye Telecommunications, nominated by the Electronic Engineering Association); J. Clarricoats (R.S.G.B.); Major General E. S. Cole (War Office); N. H. Elgood (Home Office); Sir Robert Fraser (I.T.A.); Supt. F. Gee (Lancashire Constabulary); H. Gillender (Ministry of Transport); H. van Hasselt (S.T.C., nominated by the



Telecommunication Engineering and Manufacturing Association); G. P. Jefferies (Ministry of Aviation); K. I. Jones (Ferguson, nominated by B.R.E.M.A.); R. J. Kemp (Marconi's, nominated by E.E.A.); Air Commodore C. C. Morton (British Joint Communications Electronics Board); Capt. W. J. Parker (Admiralty); G. F. Peirson (Midlands Electricity Board); C. G. Phillips (Ministry of Aviation); D. J. A. Stevenson (Automobile Association, nominated by the Mobile Radio Users' Association); H. E. F. Taylor (E.E.A.); Air Commodore F. E. Tyndall (Air Ministry); A. Wolstencroft (Post Office); Capt. F. J. Wylie (Radio Advisory Service of the Chamber of Shipping and Liverpool Steamship Owners' Association); and J. E. Golothan (Post Office), secretary.

**H. G. Whiting**, A.M.I.E.E., has been appointed Regional Engineer, B.B.C. Midland Region, in succession to **W. A. Roberts**, M.I.E.E., who becomes Administrative Officer in the Region. Mr. Roberts, who joined the Engineering Division of the B.B.C. in 1937, became assistant to the Chief Engineer in 1949. He was a member of the Broadcasting Commission appointed by the Gold Coast (now Ghana) Government in 1953 to advise on the development of broadcasting in that country, and later of the Commission which was appointed to study broadcasting development in Kenya. During 1954 and 1955 he was seconded to the Colonial Office as technical adviser on broadcasting development in the Colonies. Mr. Whiting joined the Corporation in 1932 as an engineer in the Transmitter Department. He transferred to the Television Service in 1936, and since 1952 has been Engineer-in-Charge, Television, Birmingham.

**T. H. Cook**, B.Sc.(Eng.), M.I.E.E., has been appointed chief applications engineer of the Morgan Crucible Co. He was previously technical sales manager of the company's carbon department. He will be attending the New Delhi meeting of the International Electrotechnical Commission in November.

**G. D. Speake**, M.A., has been appointed deputy chief of research of Marconi's research and development laboratories, Great Baddow, Essex. He joined the company in 1950 at the age of 31 and was engaged in radar systems research until 1954, when he was appointed chief of the vacuum physics division. Two years later he took charge of the microwave physics section. Educated at St. Catharine's College, Cambridge, where he graduated with first-class honours in physics, he served in the Technical Branch of the R.A.F. as a flight-lieutenant, and was for four years with Imperial Chemical Industries as instrument manager of the plastics division before joining Marconi's.



G. D. Speake.

## OBITUARY

**Air Marshal Sir Raymund Hart**, who died as a result of an accident on July 16th at the age of 61, had been director of the Radio Industry Council since his retirement from the R.A.F. in January, last year. His Service career began in the Royal Flying Corps in 1917. In 1936 he was attached to the Bawdsey experimental station as "Commandant of R.D.F. Training" and so began his long and close association with radar development. It was Sir Raymund who introduced the "filter room" principle into the radar reporting system. In 1942 he became Command Signals Officer of Fighter Command and was at one time Deputy Director of Radar in the Air Ministry and from 1951 to 1955 Director General of Engineering.

# News from Industry

**Pye Ltd.** and its subsidiaries increased their "total available profit" for the year ended 1959/60 by nearly 75% compared with the previous year. The figures are £1,464,274 and £842,762. The year's trading profit was £3,927,041 compared with £2,834,841 for 1958/59. The annual general meeting is being held on August 24th to coincide with the group's exhibition being held at the Royal Festival Hall, London.

**Temco.**—By the purchase of shares on the London Stock Exchange Pye have acquired a controlling interest in the Telephone Manufacturing Co. in face of a bid for the whole of the company's shares by a consortium of seven companies—A.E.I., A.T. & E., Ericsson, G.E.C., Marconi's, Plessey and S.T.C. It is Pye's intention to continue the business of Temco as a separate entity.

**Thorn Electrical Industries** group trading profit for the year ended last March was £3,916,990 compared with £2,953,536 the previous year. Deducting all charges, including taxation of £949,069, the net profit is £1,525,988 against £979,371 last year.

**Firth Cleveland Group** reports a turnover of £21.5M with a profit before taxation of £2,144,806 in 1959 compared with £1.8M and £1,455,000 the previous year. The group, which comprises about 30 companies in this country and some 20 abroad, includes Solartron, Simmonds Aerocessories, and four chains of retail radio stores totalling in all some 450 shops.

**Brimar valve and cathode-ray tube division** of Standard Telephones and Cables has been acquired by Thorn Electrical Industries Ltd. A new company is being formed under the name Brimar Electronics Ltd. The "special" valve division of S.T.C. is not included in the agreement signed by the two companies.

**Anglo-Swedish Agreement.**—Technical and commercial co-operation between E.M.I. Electronics Ltd. and the Swedish SAAB Aircraft Co. is provided for under a recently signed agreement. SAAB will sell E.M.I.'s equipment in the industrial, automation, broadcast, instrument and special tube fields throughout Sweden, Norway and Denmark, through its sales organization, SAAB Electronics. E.M.I. will market SAAB products in the British Commonwealth and other countries.

**Associated Electrical Industries Ltd.** and Davy-United Ltd. have formed a jointly financed Steelworks Automation Unit to apply new automatic control techniques to the processing both of steel and of non-ferrous metals. The A.E.I./Davy-United Steelworks Automation Unit has its headquarters at Mill Road, Rugby.

**Hughes International (U.K.) Ltd.**, set up in Glenrothes, Fife, by the Hughes Aircraft Co. of the U.S.A. for the manufacture of a wide range of semiconductor components for the European market, plans to open its factory this month. David Simpson is general manager of the Scottish company.



A trade exhibition is being held by Thompson, Diamond & Butcher at the Trocadero Restaurant, Piccadilly Circus, London, W.1, from August 23rd to September 1st. T.D.B. are both wholesalers and manufacturers; they make the range of "Top Rank" record players. Invitation tickets are obtainable by writing to the Sales Manager, 1/9 University Street, London, W.C.1.

**McCarthy Radio and Electronics Ltd.**, of Studland Street, London, W.6 (Tel.: Riverside 1633) is the new name of what was previously Radio Mailing Ltd. The company, of which A. S. Williams is managing director, manufactures McCarthy radio-grams, record players and tape recorders, and Felgate inverters.

**Elstone Electronics Ltd.**, of Hereford House, North Court, Vicar Lane, Leeds, 2 (Tel.: Leeds 35111), of which A. C. Farnell and A. Woffenden are directors, have been appointed British distributors for Weller Elektro-Werkzeuge, of West Germany. The company manufactures soldering guns and heat-controlled soldering irons.

**Stretch**, the IBM computer capable of performing well over a million logical operations per second, has been ordered by the U.K. Atomic Energy Authority. The system, to be installed towards the end of 1961, will have random access disc storage units capable of transferring one word every 8 microseconds, 6 magnetic core storage units with retrieval time of 2.18 microseconds, and a vast magnetic tape backing store.

**Films & Equipments Ltd.**, of 138 Wardour Street, London, W.1 (Tel.: Gerrard 7711), of which D. Forrester and G. M. Forrester are directors, have disposed of their recording division to Aviation and Electronic Equipment Ltd., of the same address. The company's connector division has been taken over by Cannon Electric (Great Britain) Ltd., also of the same address.

**Decca** has obtained from Thermionic Products the sole manufacturing rights of their micro-lift for pickups.

**Solartron Electronic Group** is to provide the instrumentation and control apparatus for the next major experiment for controlled thermo-nuclear research to be undertaken by the Atomic Energy Authority. The intermediate current stability experiment (I.C.S.E., pronounced "ice") will be undertaken at the new laboratory which the A.E.A. is establishing at Culham, near Oxford.

**G.E.C.** is to supply and install for the Post Office a dual radio link between Carlisle and Kirk o' Shotts for the relaying of television transmissions. There will be two intermediate repeater stations along the 90-mile route. The broadband equipment, which operates around 6,000Mc/s can provide a television link or 960 speech circuits.

The **printed circuits division** of Mills & Rockleys (Production) Ltd. has been formed into a separate subsidiary company called Mills & Rockleys (Electronics) Ltd., of Swan Lane, Coventry (Tel.: Coventry 26222). The general manager is D. L. Phillips.

**Teleng Ltd.** are to design and supply the distribution equipment and cabling for the television relay system to be installed by Marconi's on the new luxury liners, *Oriana* and *Canberra*.

## EXPORT NEWS

**British manufacturers** who are participating in the exhibition being held in Stockholm from September 10th to 17th in conjunction with the Fifth International Instruments and Measurements Conference include: Ether Langham Thompson, G.E.C., General Radiological, Hobson, Plessey, Solartron, 20th Century, Ultra, A.E.I., Cannon Electric, Colvern, Erie, Hunt and Texas Instruments. The last six companies are combining as the "English Component Group" through an agent.

**Sub-miniature** automatic direction-finders made by Bharat Electronics, of Bangalore, under a general manufacturing agreement made between the Government of India and Marconi's W/T Co., are to be fitted in AVRO-748 twin turbo prop aircraft being built in India. The radio compass is Type AD722.

**Airfield control radar** is being supplied by Cossor Radar and Electronics to the East African Directorate of Civil Aviation for installation at the recently opened Nairobi Airport.

**Closed-circuit television** equipment was recently installed by Marconi's on a locomotive of Rhodesian Railways so that the action of the wheels could be studied while in motion because abnormal wear had been noticed on sharp curves of the track.

**An O.B. television unit** has been supplied to the Hungarian broadcasting authority by E.M.I. Electronics. The unit, mounted on a 7-ton chassis, is equipped with four image orthicon cameras.

**Colour TV.**—The colour television unit commissioned by Smith Kline & French Laboratories from Marconi's two years ago, which has been placed by the owners at the free disposal of medical authorities in this country, is now on a three-month tour of Australia. It will visit hospitals in Adelaide, Melbourne, Brisbane and Sydney. Marconi's have provided the engineering team accompanying the vehicle.

**Hong Kong.**—The mast of the Colony's new v.h.f./f.m. broadcasting station. Four Marconi 5-kW transmitters in two parallel pairs are used to radiate two programmes—English on 91Mc/s and Chinese on 94Mc/s.



# LETTERS TO THE EDITOR

The Editor does not necessarily endorse the opinions expressed by his correspondents

## Negative Resistance

HAVING studied "Cathode Ray's" article "Ohm's Law and Negative Resistance" in the July issue I can now see how our differences of opinion as to whether or not a battery is equivalent to a negative resistance can be resolved.

But first, since it is hard to find a text-book which even hints that Ohm did not create Ohm's Law, "Cathode Ray's" main point in his 1953 article, that there are two distinct Ohm's Laws, should be brought to the attention of all text-book writers.

Very briefly, the first Law is based on Ohm's work and might be called Ohm's Linearity Law  $R=K$ ; the second is what has become to be called Ohm's Law,  $R=E/I$ , which defines the ohm and in which  $R$  need not be constant, and is replaced by  $Z$ , the impedance, for a.c. working.

B.S. definition No. 1276 quoted by "Cathode Ray," expresses my point that for a device to be a resistance the voltage and current must be related. When shortened, the second paragraph of the definition reads, "The resistance is equal to the applied p.d. divided by the current which it produces when the body has no e.m.f. acting therein."

Hence a battery cannot be a resistance and Ohm's Law cannot be applied to it, which was the basis of my original objection. But Ohm's Law can be applied (without any modification) to a resistance having the same p.d. and current as the battery at any particular instant, and the battery can be said to be equivalent to the resistance in certain respects.

If the current through the battery is reversed, the battery absorbs energy and becomes equivalent to a positive resistance. If the battery is an accumulator on charge or even a dry cell (see, for instance, R. W. Hallows, "Reactivating the Dry Cell" *W.W.* August, 1953) some of the energy may be stored chemically, whereas in a resistor it is all dissipated. But inductances and capacitances, both positive and negative, can absorb or give out energy; the battery actually behaves much more like a large charged positive capacitance than a resistance if any changes are made to the circuit.

An engineer might ask, "Does it work?" "Cathode Ray" has shown that the battery and resistance in the circuit are equivalent to two resistances, one of which is equal to the negative of the other, and these are equivalent to a short-circuit. This simplifies the circuit but makes it impossible to find the current.

A similar thing happens when solving simultaneous equations if one substitutes twice in the same equation.

One proves that  $0=0$ , which does not help in finding  $x$ .

As regards "Kirchhoff's" Third Law, in a simple loop where all components pass the same current, the Law is reduced to Ohm's Law to Kirchhoff's Second Law, while if the mesh is part of a network and the current is different in different parts of the mesh, the Third Law does not hold.

Binley, nr. Coventry.

D. L. CLAY.

## Analogue Computer Techniques

THE simple analogue computer as described by G. B. Clayton (May and June issues) can be used to demonstrate many problems.

A familiar example is that of the simple projectile which moves with initial velocity  $V$  ft/sec, included at an angle  $\theta$  to the horizontal, with downward acceleration  $g$  ft/sec<sup>2</sup> due to gravity.

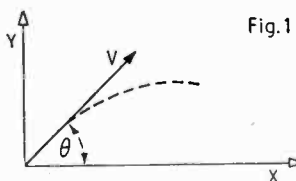

Fig. 1

With the notation of Fig. 1, the displacements in the X and Y directions after time  $t$ , are given by the equations.

$$Y = Vt \sin \theta - \frac{1}{2}gt^2$$

$$X = Vt \cos \theta$$

By assigning fixed voltages to represent the constants  $V$  and  $g$ , it is possible to generate voltages representing these displacements using a computer arrangements as in Fig. 2.

The outputs obtained can be fed into the X and Y plates of a cathode ray tube, and a trace will be produced representing the path of the projectile. It is quite easy to demonstrate the effect of varying either  $V$ ,  $g$ , or  $\theta$ , the latter set by the potentiometers representing  $\sin \theta$  and  $\cos \theta$ , both of which must be adjusted for any change of  $\theta$ .

The more complex case of the catenary can be illustrated in this way, this being the curve in which a uniform chain or "perfectly flexible" string hangs when freely suspended from two fixed points.

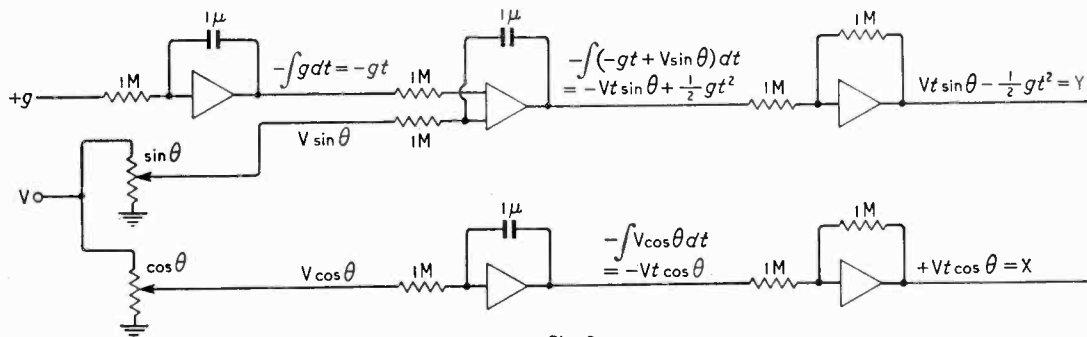

Fig. 2

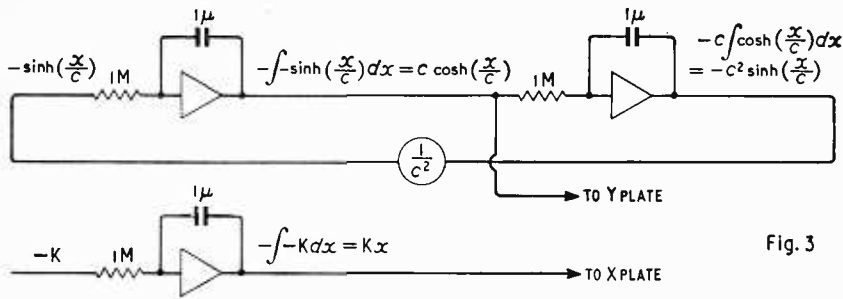

Fig. 3

The equation for the curve is

$$y = c \cosh(x/c)$$

The computer can be used to obtain such a function, by first assuming a signal for  $-\sinh(x/c)$  and integrating twice with respect to  $x$  ( $x$  here being represented by time).

The output of the second integrator is  $-c^2 \sinh(x/c)$  which can be modified to  $-\sinh(x/c)$  by use of a potentiometer set to  $1/c^2$ . Thus by assuming  $-\sinh(x/c)$  we have obtained  $-\sinh(x/c)$ , and hence if the output is fed back into the input, the circuit will produce functions as indicated in Fig. 3, the output of the first integrator  $c \cosh(x/c)$  being fed to the Y plate

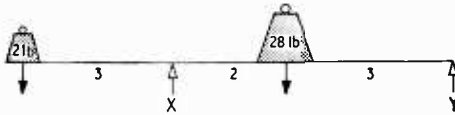

Fig. 4

of an oscilloscope. The X Plate is fed with voltage  $Kx$ , which increases linearly with  $x$ . Such a voltage is readily obtained by integrating a constant voltage  $-K$  as indicated.

The effect of changing  $c$  can be seen by observing the different oscilloscope traces for various settings of the  $1/c^2$  potentiometer.

A further technique worthy of mention, is that of a method of solution of simultaneous equations, such as those arising from simple beam problems. For instance if we have a light uniform beam simply supported as in Fig. 4, and with weights of 2 lb and 28 lb as shown, it may be required to find the reactions at the supports X and Y.

By resolving vertically and taking moments, the following equations for X and Y are obtained.

$$X + Y = 30 \quad \therefore Y = 30 - X$$

$$2X - 3Y = 10 \quad \therefore X = \frac{10 + 3Y}{2}$$

Using these relationships and assuming a signal for  $-3Y$ , summing amplifiers can be used to develop signals for X and thence  $-3Y$ , and by feeding the output back to the input the above equations can be satisfied (see Fig. 5).

If the appropriate fixed voltages of  $-10$  and  $-30$  are applied as shown, using a scaling of 1 volt  $\equiv$  1 unit, then the values of X and Y can be read as the output voltages of amplifiers 1 and 2 respectively.

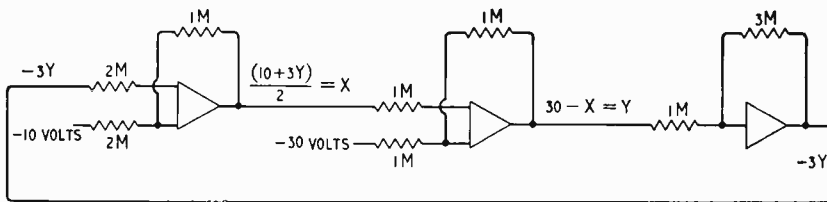

Fig. 5

This technique cannot always be used, since certain types of equations will require a computer arrangement which may be unstable. In these cases more advanced methods of solution are used.

A demonstration of these uses of the analogue computer has been made by Louis Newmark Ltd., to the sixth form students of Orpington Grammar School, where the interest aroused is now building its own

was such that the school computer.  
New Addington,  
Surrey.

M. A. COLLINS,  
Louis Newmark Ltd.

### Line Standards

YOUR leading article on number of lines is a refreshing change in that an authoritative opinion favours retention of 405 lines in this small island of ours, with its attendant co-channel problems.

The writer sees little to recommend a change except perhaps exchange of programmes with the Continent and the advent of colour. For the former it would be cheaper to arrange a separate camera chain from the studio on 625 lines when an exchange with Europe was necessary. 625 lines would not help a great deal with picture degradation when changing to French 819 lines.

Regarding colour, the writer recently saw the latest adaptation of the N.T.S.C. system on 405 lines at the laboratory of a leading manufacturers and the results would have satisfied even the most artistic viewer, the compatibility being excellent.

Living near the Continent the writer often has the chance to view television in the average home on 625 and 819 lines. On 625 there is no significant improvement, but with 819, provided that the television is in reasonable alignment, and the aerial system covers the bandwidth required, the picture quality is a marked improvement; but the writer has noticed when the bandwidth is restricted for any reason, the result is a very unpleasant comparison of good vertical definition with poor horizontal detail.

At present in this country, towns served by i.f. wired systems do not enjoy in most cases more than 2 Mc/s bandwidth on the whole network, so any overall improvement would be lost to these viewers.

Dover.

B. A. A. SMYE-RUMSBY

### "Things Great and Small"

IN reference to "Random Radiations" in the June 1960 *Wireless World*, I would call to your attention a fund of information on prefixes in "The Greeks Had a Word for It," by A. P. G. Peterson, in the *IRE Transactions on Engineering Writing and Speech*, December, 1959.

Of passing interest is the fact that the Greeks did indeed have words for quantities above 1,000. Herodotus in his history, Book VII, Polymnia section 60, counts Xerxes' Army in terms of myriads (literally,  $\mu\pi\rho\iota\sigma\iota$ , his word for 10,000). Also, Archimedes devised a set of names for numbers greater than 10,000, using as a base the octad ( $10^8$ ).

But of major significance in the article is the set of metric prefixes Dr. Peterson proposes. Here is a simple method of prefixes that takes us from  $10^{-30}$  to  $10^{30}$

with logic not found in the likes of nano, giga, tera, and pico.

Basically, a Peterson prefix is, for positive powers of 10, a Greek prefix and an "ilo." The "ilo" comes from the prefix for 10<sup>3</sup>, kilo, a serves to identify the prefix immediately as being positive. For negative prefixes, Peterson combines standard Latin prefixes with "illi" (from milli, the prefix for 10<sup>-3</sup>). The following table shows how ingeniously simple this system is.

Value	Prefix	Symbol	Value	Prefix	Symbol
10 <sup>3</sup>	kilo	K	10 <sup>-3</sup>	milli	m
10 <sup>6</sup>	dilo	D	10 <sup>-6</sup>	billi	b
10 <sup>9</sup>	trilo	TR	10 <sup>-9</sup>	trilli	t
10 <sup>12</sup>	tetrilo	TT	10 <sup>-12</sup>	quadrilli	qd
10 <sup>15</sup>	pentilo	PN	10 <sup>-15</sup>	quintilli	qn
10 <sup>18</sup>	hextilo	HX	10 <sup>-18</sup>	sextilli	sx
10 <sup>21</sup>	heptilo	HP	10 <sup>-21</sup>	septilli	sp
10 <sup>24</sup>	oktilo	OK	10 <sup>-24</sup>	octilli	oc
10 <sup>27</sup>	enneilo	EN	10 <sup>-27</sup>	nonilli	nn
10 <sup>30</sup>	dekilo	DK	10 <sup>-30</sup>	decilli	dc

It is a pity that Peterson's article wasn't published 10 years ago, before such allogical absurdities as giga won their acceptance through default. But it is only a matter of time before man is again bogged down for lack of additional prefixes, and then perhaps logic will have its day.

Meanwhile, several publications have reprinted the Peterson article, and I recommend it to those who crave logic in language.

Lexington, Massachusetts, U.S.A.  
**FREDERICK T. VAN VEEN**

### Self-balancing Push-pull Circuits

MR. BIRT'S reply to the first part of my letter in the August issue is quite acceptable. In fact, by showing how the magnetic coupling in the output transformer ensures no error-signal at the junction of R<sub>1</sub>-R<sub>2</sub> in my two-stage amplifier (Fig. 1, p. 397), Mr. Birt makes "a fair cop". Apparently, in this case, to take the error-signal from a resistor at the primary tap is the only way. Even so, this could be coupled to the first stage common bias resistor without the intervention of a "gainless" valve stage; the gain over two stages—especially if the first is a pair of pentodes or cascodes (not cross-coupled)—ensures very close balance.

The diagram herewith shows a "Croscode" with

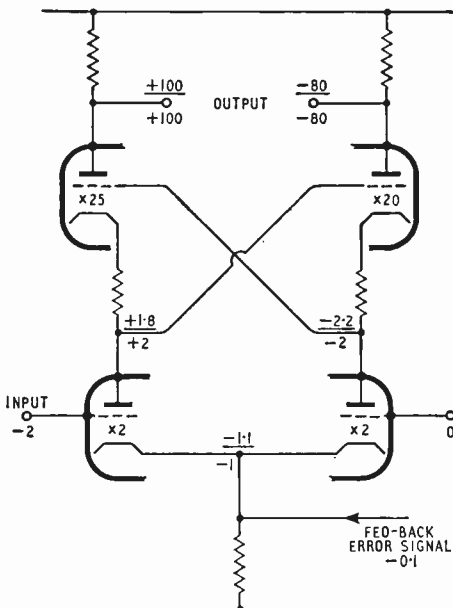

lower triodes having a gain of  $\times 2$ , the right upper triode  $\times 20$ , and the left upper triode  $\times 25$ . Tracing through (plain figures) an a.c. signal with an instantaneous input of  $-2$  shows an unbalanced output of  $-80$  and  $+100$  at the anodes. Now adding a fraction of the error-signal in reversed phase of  $-0.1$  at the cathodes (*relatively* positive feedback to the right side and negative to the left), the signal thus modified is traced through afresh (underlined figures). It is seen that the grid-cathode signal to both upper triodes is still 4, as before, and the output balance *not improved*. Thus, the "Croscode" does not lend itself to self-balancing by the methods under discussion. (Easy figures, rather than practical, are used for illustrating the principle.)

To save the Editor's precious space I leave the reader to re-draw the diagram *without* cross-coupling (i.e. with earthed upper grids), not forgetting that the gain of the lower triodes is now  $\times 4$  as explained by Mr. Birt (p. 283, June issue). Tracing through the same signal, it will be found now that adding a  $-0.1$  error-signal improves the balance to  $-88$  and  $+90$ .

Walsall, Staffs.

STANLEY MAY

### EDUCATIONAL AIDS

THE photographs show top and bottom views of the Associated Electrical Industries Type R2330 amplifier, one of a new range of educational aids. Also in-

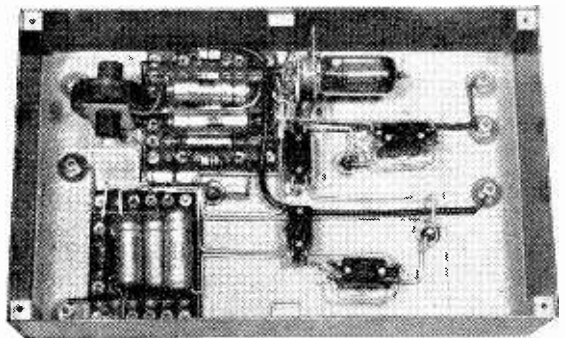
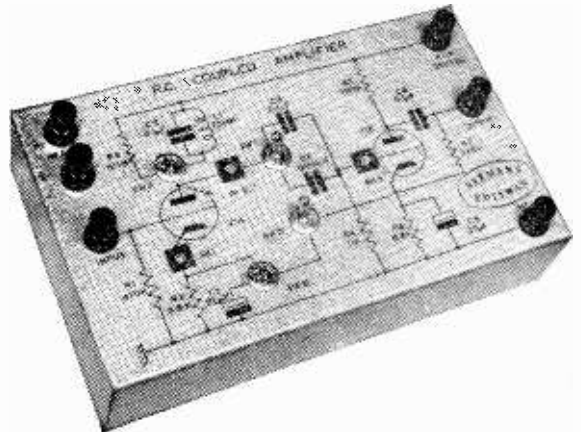

cluded in this range are a power output stage, R-C coupled and tuned-anode oscillators, and high- and low-pass filters. Each unit is fitted with a Perspex base so that the wiring and construction can be seen and compared with the circuit diagram printed on the cover: this circuit diagram is also connected to the actual terminals where appropriate. Each unit is supplied with instructional sheets giving theoretical and practical details of a number of suggested experiments.

# National Radio Show Guide

THE 27th British National Radio and Television Show at Earls Court opens to the public on August 24th with a preview for overseas visitors and invited guests the day before. Organized by Radio Industry Exhibitions on behalf of the British Radio Equipment Manufacturers' Association it is essentially a domestic sound and television equipment show, although the Services,

B.B.C. and I.T.A., provide interesting background. We give in the following pages a preview of the technical exhibits compiled from information available at the time of going to press. The stands in the Audio Hall are covered in a separate section at the end. In the October issue we shall give an assessment of trends in the design of equipment as portrayed at the Show.

## ALPHABETICAL LIST OF EXHIBITORS

<b>A.E.I.</b> .....	21 (X27)	Casian	219	Ever Ready	34 (X10)
Admiralty	407	Charterhouse Credit Co.	8	<b>Ferguson</b>	39 (X5)
Aerialite	13	Chorlton & Co.	217	Ferranti Radio & TV	20 (X30)
Air Ministry	406	Collaro	38	Fidelity Radio	48
Alan-Markovits	115	Cossor Radio & TV	57	Fountain Press	124
Alba	16	<b>Dansette</b>	44	Fund for the Blind	414
<i>Amateur Tape Recording</i>	412	Decca Records	35 (X6 & X7)	<b>G.E.C.</b>	32 (X24)
Amnion	54	Defiant	7	G.P.O.	403
<b>Antiference</b>	17	Design Furniture	103	Gala Records	202
Argosy Radiovision	61	Domain Products	214	Garrard	56
Associated Television	74	Dublier	62	Goodmans	220
<b>B.B.C.</b>	408, 409 & 410	Dynatron	52	Gramophone Co.	46 (X11)
Barclays Bank	203	<b>E.M.I. Records</b>	65	<b>Hacker Radio</b>	113
Belling & Lee	63	E.M.I. Sales & Service	24	Heathkit	112
Bernards (Publishers)	125	Econasign	121	"His Master's Voice"	33 (X9)
Bowmaker	216	Ekco	58 (X8)	Hobday, Christopher	221 (X25)
Brimar Electronics	104	<i>Electrical &amp; Radio Trading</i>	111	Home Maintenance	118
Bulgin	66	<i>Electronic Technology</i>	204	Hunts Capacitors	49
Bush	51 & 60 (X14)	Elizabethan	26	<b>I.T.A.</b>	74
"Careers"	405	Emerson Electronics	50		

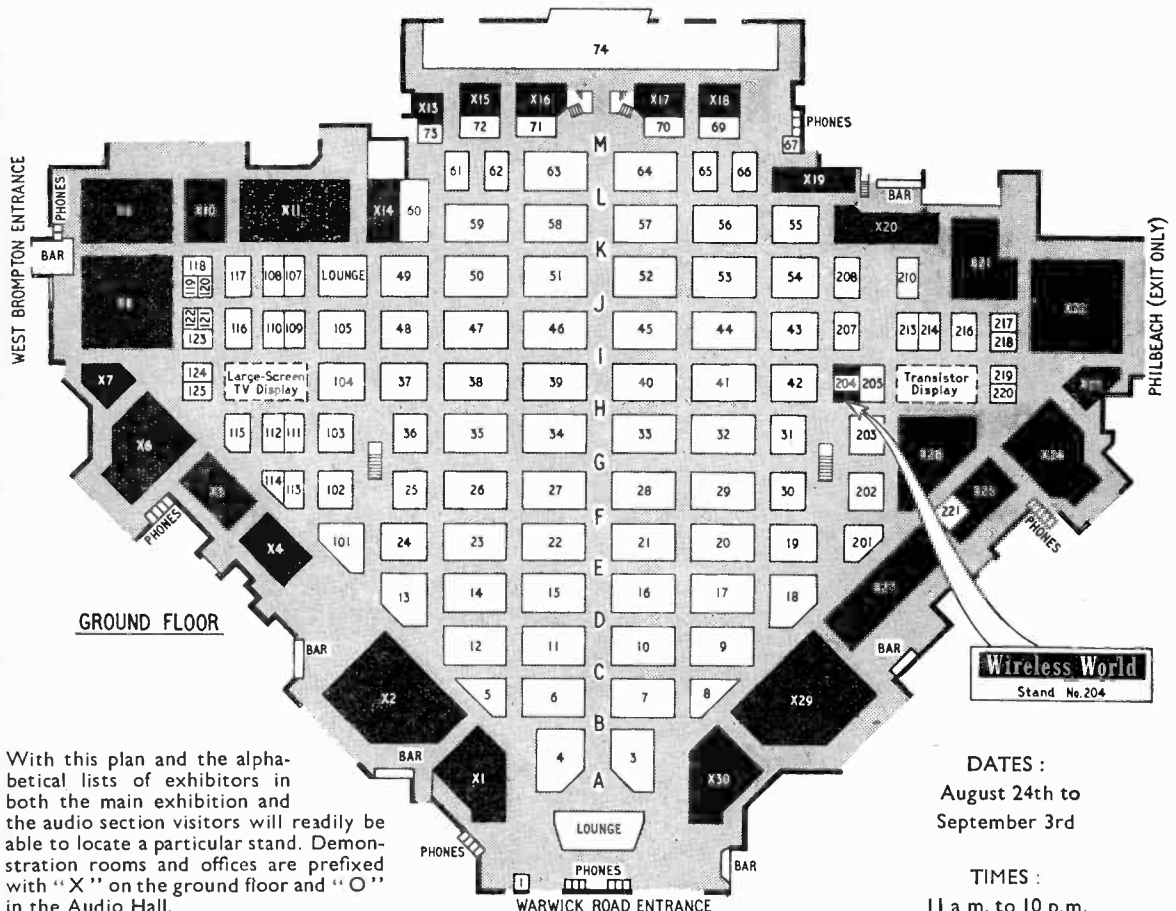

With this plan and the alphabetical lists of exhibitors in both the main exhibition and the audio section visitors will readily be able to locate a particular stand. Demonstration rooms and offices are prefixed with "X" on the ground floor and "O" in the Audio Hall.

**DATES :**  
August 24th to  
September 3rd

**TIMES :**  
11 a.m. to 10 p.m.

<b>J-Beam</b> .. .. .	5	<i>Radio Retailing</i> .. .. .	124	<i>Teleng</i> .. .. .	107
<b>Keith Prowse</b> .. .. .	1	<i>Record Housing</i> .. .. .	116	<i>Telerection</i> .. .. .	28
<b>Kerry's</b> .. .. .	19	<i>Redicord</i> .. .. .	123	<i>Telesurance</i> .. .. .	9
<b>Kolster-Brandes</b> .. .. .	22 (X4)	<i>Regentone</i> .. .. .	59	<i>Territorial Army</i> .. .. .	413
<b>Labgear</b> .. .. .	25	<i>Roberts</i> .. .. .	70 (X17)	<i>Tricity Finance Corp.</i> .. .. .	36
<b>Lee Products</b> .. .. .	55	<i>Rola Celestion</i> .. .. .	213	<i>Trix</i> .. .. .	37
<b>Le Grest</b> .. .. .	122	<i>Rose Projects</i> .. .. .	119	<b>Ultra</b> .. .. .	15 (X2)
<b>Lifeguard</b> .. .. .	30	<b>S.T.C.</b> .. .. .	14	<b>Valradio</b> .. .. .	114
<b>Linguaphone Institute</b> .. .. .	109	<i>Slingsby</i> .. .. .	31	<b>Vulcan Finance</b> .. .. .	207
<b>Lloyds Bank</b> .. .. .	4	<i>Sloss, Andrew</i> .. .. .	102	<b>Walter Instruments</b> .. .. .	72 (X15)
<b>Marconiphone</b> .. .. .	47	<i>Sobell</i> .. .. .	64 (X21)	<b>Westminster Bank</b> .. .. .	18
<b>Markovits</b> .. .. .	120	<i>Southern Television</i> .. .. .	74	<b>Whiteley</b> .. .. .	69 (X18)
<b>Martins Bank</b> .. .. .	105	<i>Southgate Tubular Products</i> .. .. .	210	<b>Wireless for the Bedridden</b> .. .. .	67
<b>McMichael Radio</b> .. .. .	53	<i>Star</i> .. .. .	404	<i>Wireless &amp; Electrical Trader</i> .. .. .	110
<b>Mercantile Credit Co.</b> .. .. .	208	<i>Stella</i> .. .. .	6	<i>Wireless World</i> .. .. .	204
<b>Midland Bank</b> .. .. .	12	<b>T.C.C.</b> .. .. .	42	<i>Wolsey</i> .. .. .	43
<b>Metropolitan Police</b> .. .. .	402	<i>Tape Recorders</i> .. .. .	3		
<b>Mullard</b> .. .. .	40 (X19, X20 & X22)				
<b>Multicore</b> .. .. .	71 (X16)				
<b>Murphy</b> .. .. .	23 (X1)				
<b>National Provincial Bank</b> .. .. .	101	<b>A.E.I. Sound Equipment</b> .. .. .	308	<b>Gramdeck</b> .. .. .	314
<b>NEV</b> .. .. .	218	<i>Acos</i> .. .. .	310 (O2)	<b>Gramophone Co.</b> .. .. .	323 (O1)
<b>Perdio</b> .. .. .	41	<i>Alba</i> .. .. .	306	<b>Lustraphone</b> .. .. .	309
<b>Perth Radios</b> .. .. .	205	<b>Brenell</b> .. .. .	311	<b>Philips</b> .. .. .	320
<b>Peto Scott</b> .. .. .	27	<b>Decca</b> .. .. .	303	<b>REPS</b> .. .. .	305
<b>Philco (Overseas)</b> .. .. .	45 (X23)	<i>Dynatron</i> .. .. .	313	<i>Rola Celestion</i> .. .. .	312
<b>Philips</b> .. .. .	10 (X29)	<b>E.A.R.</b> .. .. .	319	<b>Symphony Amplifiers</b> .. .. .	302
<b>Pilot Radio &amp; TV</b> .. .. .	11	<i>Expert Gramophones</i> .. .. .	307	<i>Tape Recording Hi-Fi Magazine</i> .. .. .	321
<b>Pitrie</b> .. .. .	108	<b>Ferguson</b> .. .. .	324	<b>Truvox</b> .. .. .	317
<b>Plessey</b> .. .. .	73 (X13)	<b>G.E.C.</b> .. .. .	322	<b>Whiteley</b> .. .. .	304
<i>Practical Wireless</i> .. .. .	117	<i>Gainsborough Tape Recorders</i> .. .. .	301		
<b>R.G.D.</b> .. .. .	29 (X26)	<i>Goodmans</i> .. .. .	316		
<b>R.S.G.B.</b> .. .. .	411				
<b>R.T.R.A.</b> .. .. .	201				

### AUDIO HALL (First Floor)

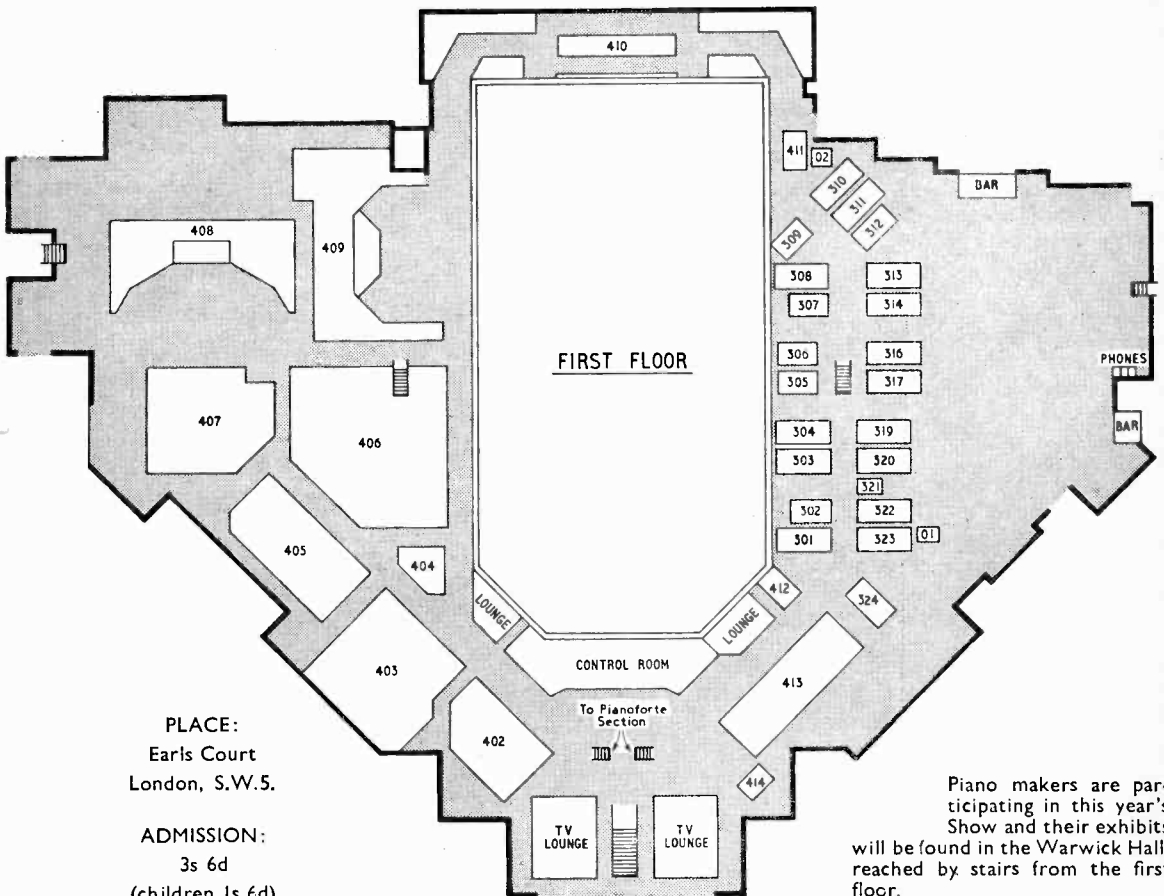

# NATIONAL RADIO SHOW

## Guide to the Stands

### A.E.I. (21)

Prominent among the exhibits on this stand is the Type CME2104, short-neck, 21-in television tube. It has a tri-potential electron-gun assembly and the overall length is only 13½ in. It has a 12.6V heater and forms a companion for the CME1705, 110°, 17in model introduced last year.

Semiconductor devices include the new Mazda XA161 and XA162 high-speed switching transistors of "mesa" construction and a 100-Mc/s amplifier transistor, the XA131. Also included are three n.p.n. switching transistors and a comprehensive range of transistor packages for the entertainment industry.

There is a representative group of Siemens-Ediswan dry batteries and among other items a range of Solon electric soldering irons.

*Associated Electrical Industries Ltd., 155 Charing Cross Road, London, W.C.2.*

### ADMIRALTY (407)

"Navigation and charting the seas" is the theme of the Navy's display which is centred around a mock-up of a ship's bridge and plotting room. Amongst the equipment to be seen in this mock-up is the Two-range Decca Navigator, a radar display with chart comparison unit and a low-power transmitter-receiver. Airborne equipment including a u.h.f. direction finder is also on show together with a radar simulator for training purposes and a flight data system.

*Admiralty, Whitehall, London, S.W.1.*

### AERIALITE (13)

In addition to ranges of aerials for television and radio for both overseas and home markets, cables for wired television and radio distribution will be shown. Two new cables will be introduced—one will be a "trunk" cable of low attenuation in Band III and another, utilizing an unusual construction, for which very low radiation is claimed. Also shown will be distribution amplifiers and installation accessories such as plugs and sockets and aerial filters.

*Aerialite Ltd., Castle Works, Stalybridge, Cheshire.*

### AIR MINISTRY (406)

Many examples of electronic and radio aids used both operationally and in training by the Royal Air Force are shown on this stand. The use of the automatic landing system developed by the Blind Landing Experimental Unit of the Royal Air-

craft Establishment is illustrated, and among the training equipment shown is the trainer Type 102, which simulates the operation of airborne radar navigational and bombing aids.

*Air Ministry, Adastral House, Theobalds Road, London, W.C.1.*

### ALAN-MARKOVITS (115)

Embellishments in the form of metal escutcheons, decorative fittings, cut-outs of various kinds and die-stamped name plates in a wide range of designs are made by this firm.

*Alan-Markovits Ltd., Emblem House, Sussex Road, Hove, Sussex.*

### ALBA (16)

The very wide range of models displayed includes transistor and mains receivers, stereo record reproducers and radio-grams, the Duchess tape recorder and several television sets. Special features of these last are the mounting of the components on plug-in sub-chassis for ease of servicing, and provision of gated a.g.c. for more accurately reproducing picture contrasts. An unusual feature of the new Model T766 is that the brightness and contrast controls are preset. This model also uses an extra-short necked 110° tube for minimizing the cabinet depth.

*Alba (Radio and Television) Ltd., Tabernacle Street, London, E.C.2.*

### AMPLION (54)

Shown by this company are a number of record reproducers, tape recorders and battery eliminators, as well as a stereo amplifier and transistor receiver. The "Marine" tape recorder is very unusual in that it can be operated from d.c. as well as a.c. mains.

*Amplion Ltd., 175-179 Cricklewood Lane, London, N.W.2.*

### ANTIFERENCE (17)

The "Cresta"—a new "in-the-room" B.B.C.-I.T.A. television aerial, which uses a full-wave Band-III dipole matched for extra gain and control over the radiation pattern, will be featured on this stand, together with new loft aerials. The remainder of the display will comprise a complete range of television and radio aerials and accessories for both home and overseas channel allocations; mounting brackets, masts, etc.; and a new "Autex" car-radio aerial.

*Antiference Ltd., Television and Radio Aerial Division, Bicester Road, Aylesbury, Buckinghamshire.*

### ARGOSY (61)

The two new television receivers shown on this stand employ substantially the same circuitry, are housed in matching cabinets and differ only in the tuning systems employed. One, Model 17K12, has push-button selection of five stations, while the Model 17K14 has rotary-switch selection of all 13 channels. Both sets have 17in, 110° electrostatic focus tubes.

Sound radio sets include a transistor portable and an AM/FM table model, while for sound reproduction there is a neat and compact 2-valve, 4-speed auto-record player (Model AP11) and a single-speed (3½in/sec) tape recorder.

*Argosy Radiovision Ltd., Eastern Avenue West, Romford, Essex.*

### B.B.C. (408, 409, 410)

Two of the three B.B.C. stands are devoted to entertainment—408 the "Gramstand" and 409 the "Teletage." Part of stand 410 is devoted to the activities of the Corporation's engineers in research and development. Here will be seen a remotely controlled TV camera designed and produced by B.B.C. engineers. The advances made in the application of transistor techniques in various types of equipment are also illustrated in this section.

Although not strictly a technical feature, the specially constructed news studio, from which bulletins will be actually broadcast in the Light Programme, is of particular interest. Members of the Engineering Information Department are manning an information centre located between stands 408 and 409.

*British Broadcasting Corporation, Broadcasting House, London, W.1.*

### BELLING-LEE (63)

A range of set-top, or "in-the-room," aerials will form part of the display on this stand. Making its debut beside the well-established "Golden-V" and "Metropolitan" aerials is the "Vedette"—a low-priced set-top aerial.

Other aerials to be shown include attic types for Bands I, II and III, telescopic aerials which plug directly into the aerial socket of the receiver and a wide range of outdoor aerials, including types for Band V. Also featured will be complete equipments and individual units for communal-aerial and relay systems.

*Belling and Lee Ltd., Great Cambridge Road, Enfield, Middlesex.*



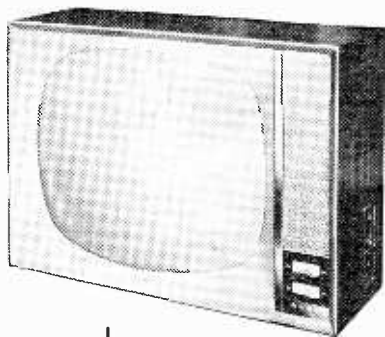

1

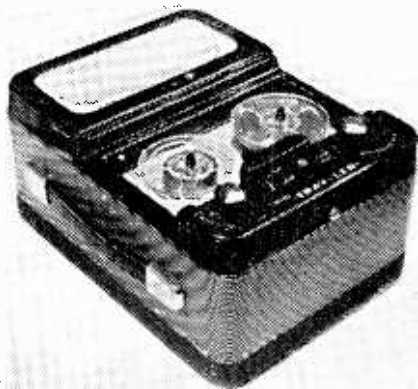

2

1. Alba T766 television receiver with preset brilliance and contrast controls.
2. Casian "Trav-ler" transistorized tape recorder.
3. Bush "Top Ten" battery 45-r.p.m. record player and fixed-tune Light Programme receiver.

#### BRIMAR ELECTRONICS (104)

A comprehensive range of valves and cathode-ray tubes for radio and television will be shown. Innovations are the 23-in 110° television tube with square corners to its screen and the ELL80 which is a double output pentode for push-pull and stereo output-stage applications.

Also shown will be the "Trustworthy" range of valves and other industrial types.

*Brimar Electronics Ltd., Footscray, Sidcup, Kent.*

#### BULGIN (66)

Many new items have been added to the Bulgin range of components recently but only a few can be mentioned here. A side-entry screened jack-plug conforming to BS666 requirements is compact, slender and has numerous applications. It is available in chrome (P535) or gold-plate (P536) finish. New side-entry plug and socket combinations are also shown.

Many additions have been made to their ranges of miniature and micro switches all of which constitute an improvement of one kind or another or to give them greater versatility. "Rocker-contact" switches of entirely new design in double- and single-pole types are now available. Some have a central "off" position and the rating is 6A to 10A at 250V a.c. Pure silver contacts are fitted and there are 8 new models in all.

*A. F. Bulgin and Co. Ltd., Bye-Pass Road, Barking, Essex.*

#### BUSH (51, 60)

On Stand 51 the complete range of television, radio, record-playing and radio-gramophone equipment produced by this company will be shown; whilst on Stand 60 working tele-

vision receivers will be massed in front of rows of seats.

New products on show will include the 21-in T.100c television receiver using the Bush push-button tuner, the TR.90 medium- and long-wave transistor portable receiver and the "Top Ten" record player. Specifically designed for the "pop" market this player is a battery-operated transistor model for 45 r.p.m. records only and it also can be switched to receive the long-wave Light Programme.

*Bush Radio Ltd., Power Road, London, W.4.*

#### CAREERS (405)

The would-be trainee will get a glimpse of the job of a serviceman from this stand, which also shows the public the standard of servicing they should expect from a dealer. There is also a display of the latest types of test equipment available to the dealer.

*B.R.E.M.A., 49, Russell Square, London, W.C.1.*

#### CASIAN (219)

Shown on this stand is the Trav-ler transistorized tape recorder. This operates at a single tape speed of 3½ in/sec and at this speed the total wow and flutter is claimed to be less than 0.4% r.m.s., the signal-to-noise ratio 30dB, and the frequency response flat within 3dB from 150 to 5,000 c/s.

*Casian Ltd., 37 Grafton House, Golden Square, London, W.1.*

#### COLLARO (38)

New additions to the range of tape decks, pickups and automatic and manual record turntables include the



TRP594 inexpensive transcription turntable and pickup arm, and the Studio C60 record changer. This latter incorporates a new speed-change mechanism which makes it impossible to change speed while the motor is running, thus avoiding one source of damage to the rubber driving wheels. The pickup arm is weight- rather than spring-counter-balanced so that the stylus pressure difference between the top and bottom records of a stack is kept below 1 gm. Also shown is the three-speed, three-motor "Studio" tape deck. This is normally fitted with two heads, but there is space for a third.

*Collaro Ltd., Ripple Works, By-Pass Road, Barking, Essex.*

#### COSSOR RADIO AND TV (57)

Two new television receivers are included this year, the CT1700U is a 17-in model with 110° tube and side-mounted, recessed controls. The loudspeaker while side mounted is canted forward for better sound distribution. Total depth is 15in. The other new model (CT2100U) is a

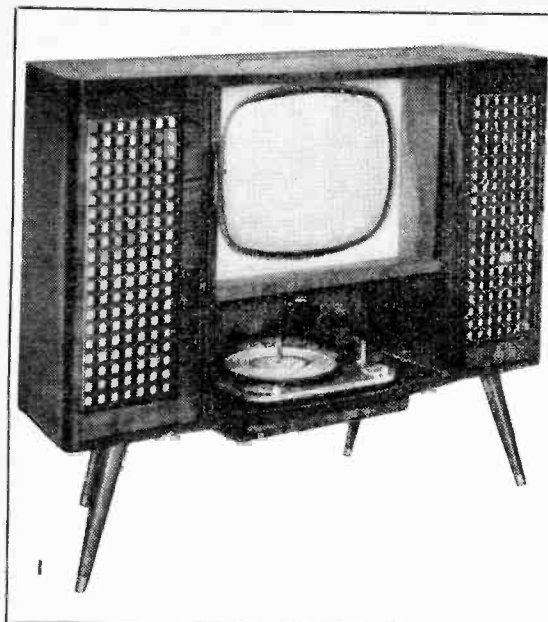

21-in version of the CT1700U and its circuitry and general features are substantially the same.

Among the new sound radio receivers is a 7-valve a.m./f.m. stereo radio-gram with two end-mounted 8-in loudspeakers. A 4-speed automatic record changer is used which is push-button operated and takes all sizes of records.

*Cossor Radio and Television Ltd., 71 Endell Street, London, W.C.2.*

#### DANSETTE (44)

A new addition to the wide range of record players and transistor receivers is the TRG45 transistor 45 r.p.m. radio-gram. This has a 600 mW push-pull output which feeds a 5-in loudspeaker. Also exhibited are a valve radio-gram, a portable stereo record reproducer, and two stereo converters.

*J. & A. Margolin Ltd., Plus-a-Gram House, 112-116 Old Street, London, E.C.1.*

#### DECCA (35)

Features of the range of television sets on show are the use of two spaced loudspeakers, tripod-mounted rotatable cabinets for readily altering the viewing direction and, for ease of servicing, a specially hinged chassis. Several of these sets incorporate v.h.f./f.m. receivers. New models introduced this year include a combined television set and v.h.f./f.m. stereo radio-gram and also a transistor radio-gram. Also shown are several transistor receivers and stereo radio-grams.

*The Decca Record Co., Ltd., 9 Albert Embankment, London, S.E.11.*

#### DEFIANT (7)

Automatic brightness control is a feature of the Defiant 2A22 21-in



2

1. Decca combined TV receiver and v.h.f./f.m. stereo radio-gram.

2. Ever Ready dual-purpose, transistor car-radio receiver.

3. Ekco's first tape recorder.

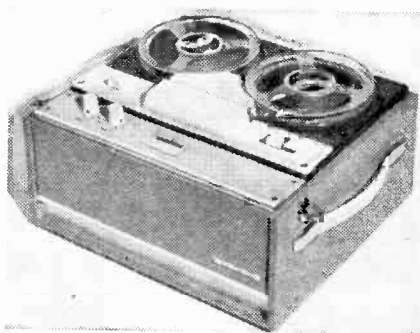

3

television receiver on which push-buttons are provided for sound tone, on/off and picture sharpness control. 17-in models will also be shown.

For radio reception seven models of table receivers and radio gramophones are offered. A new receiver—Model A52—is described as a "cordless" receiver. In fact, this is a battery-powered transistor set, in a polished-wood table cabinet, giving a three-quarter-watt output to a large loudspeaker, thus simulating the performance of a mains-driven receiver. Also shown will be three record reproducers.

*Co-operative Wholesale Society Ltd., 1 Balloon Street, Manchester, 4.*

#### DESIGN FURNITURE (103)

Tables and trolleys of various kinds, some fitted with easy-running casters and designed especially to accommodate and harmonize with modern television receivers, are shown on this stand, together with a range of record storage and equipment cabinets.

*Design Furniture Ltd., Carnwath Road, Fulham, London, S.W.6.*

#### DOMAIN PRODUCTS (214)

To the range of showroom display shelves and floor-stands, made principally of tubular steel finished in attractive colours, has this year been added the "SL" series in 2- and 3-tier types for displaying to advan-

tage modern "slimline" television sets.

*Domain Products Ltd., Domain Works, Barnby Street, London, N.W.1.*

#### DUBILIER (62)

New developments to be shown on this stand include encapsulated paper tubular capacitors which meet the RCS131 joint services standard, sub-miniature electrolytic capacitors for transistor applications, high-stability resistors and tantalum electrolytic capacitors of both solid and foil construction.

A comprehensive range of capacitors, resistors and suppression devices for the television, radio and electronics industries will complete the display.

*Dubilier Condenser Co. (1925) Ltd., Ducon Works, Victoria Road, London, W.3.*

#### DYNATRON (52)

An unusual feature of the Autoview combined 21-in television and v.h.f./f.m. receiver is that station selection is by means of push-buttons which actuate a motor-driven turret tuner. A feature of several of the single-cabinet stereo and mono a.m./f.m. radio-grams is that bass reflex loudspeaker mounting is adopted. Several record reproducers are also on show. Transistorized units include a four-

(Continued on page 441)

speed record reproducer, a radio-gram and several receivers. Newly introduced is this company's first tape recorder—the Cordova.

*Dynatron Radio Ltd., Maidenhead, Berks.*

#### E.M.I. RECORDS (65)

H.M.V., Columbia, Parlophone, Capitol, M.G.M. and Mercury records will be displayed. Comprehensive record enquiry facilities will also be available.

*E.M.I. Records Ltd., 20 Manchester Square, London, W.1.*

#### E.M.I. SALES & SERVICE (24)

On show is the complete range of Emitape magnetic recording tape for amateur and professional users, which includes 2-in wide videotape as well as ordinary-, long-, and double-play  $\frac{1}{2}$ -in tape. Also displayed is the complete range of Marconi valves.

*E.M.I. Sales & Service Ltd., Blyth Road, Hayes, Middx.*

#### EKCO (58)

Special features of several of the new television receivers on show are the use of two speakers mounted on either side of the cabinet, gated a.g.c. for more accurately reproducing picture contrasts, and the inclusion of a v.h.f./f.m. receiver.

Another new introduction is Ekco's first tape recorder which is an inexpensive, single-speed ( $3\frac{1}{2}$ in/sec) model. Record reproducers include a new portable stereo record player as well as the well-known Nine-Octave RP341 which features a tuned reflex loudspeaker cabinet, an 8-watt output and bass and treble controls.

Features of a new small transistor receiver, the PT352, are provision of a push-pull output and slow-motion tuning. The wide range of valve receivers on show includes a.m., a.m./f.m. and f.m.-only models, and the well-known Radiotime combined radio, alarm clock and time mains switch.

*E. K. Cole Ltd., Southend-on-Sea, Essex.*

#### ELIZABETHAN (26)

Two four-track models are additions to the range of tape recorders. One of these, the FT1, is claimed to give a response up to 12,000 c/s at the single speed provided ( $3\frac{1}{2}$ in/sec). The other new model, the FT3, can be operated at  $1\frac{1}{2}$ ,  $3\frac{1}{2}$  or  $7\frac{1}{2}$ in/sec. Independent mixing of two channels is also possible with the FT3. Also on show is the two-track, three-speed Major tape recorder which features a record replay head with a gap as short as 3 microns, a meter recording-level indicator and a six-watt push-pull output.

*Elizabethan (Tape Recorders) Ltd., Bridge Close, Romford, Essex.*

#### EMERSON (50)

The Models 911 and 555 transistor portable receivers have both car-aerial and personal-listening earphone

sockets and cover medium and long wavebands, as does the personal portable Model 888. A "table" model (666) also tunes over medium and long waves.

Three gramophones will be shown, two being automatic record players, one with a "slumber switch" for turning off the mains supply after the last record has been played. The Model 502 is a stereo player with external loudspeakers.

Also shown will be two medium- and long-wave radio-grams (mono) and a 21-in television receiver.

*Emerson Electronics Ltd., Brent Crescent, North Circular Road, London N.W.10.*

#### EVER READY (34)

The "Sky Baron" and the "Car Portable" are the two newest transistor sets shown on this stand. The latter is of special interest as it includes provision for operation as a portable from its own battery or as a car radio from the 12V car battery, switching from one to the other being instantaneous. It employs 6 transistors and change from medium to long waves is effected by push-button switches.

A full range of current models in transistor and valve types are also included, as well as the Berec receivers in which series the "Musketeer" and "Auto Portable" are electrically similar to the "Sky Baron" and "Car Portable" respectively.

*Ever Ready Co. (Great Britain) Ltd., Hercules Place, London, N.7.*

#### FERGUSON (39)

A transistor v.h.f./f.m. receiver will be shown on this stand. The Model 626BT is a battery-powered receiver, using nine transistors and covering

v.h.f./f.m. and medium and long waves. One-watt a.f. output is fed to an  $8 \times 5$ in elliptical l.s. and the styling is such that this set, although it has internal v.h.f. and a.m. aerials, is better regarded as a "cordless" table model than as a portable receiver. Also featured will be the Model 627 a.m./f.m. a.c./d.c. table receiver, which has a contemporary-styled case.

Several television models feature "Golden Glide" tuning—channel switching is achieved by means of a slide-bar control. Ferguson television receivers have the line and frame timebases stabilized against mains-supply variations and both horizontal and vertical retrace blanking is applied. Radio-grams and record players will also be shown: demonstrations Stand 324 (Audio Hall).

*Thorn Electrical Industries Ltd., Thorn House, Upper St. Martins Lane, London, W.C.2.*

#### FERRANTI (20)

Using the well-known B.S.R. deck, the new Ferranti Model RT1044 tape recorder has a  $7 \times 4$ in internal loudspeaker and extension l.s. sockets (output power 3W).

New 21- and 17-in television receivers are designed so that access for servicing is easy and models with and without v.h.f. radio will be shown. The personal portable transistor receiver, Model PT 1031, covers the medium-wave band and provides pre-tuned reception of the long-wave Light Programme. V.h.f./f.m. and a.m. receivers will complete the display.

*Ferranti Radio and Television Ltd., 41/47 Old Street, London, E.C.1.*

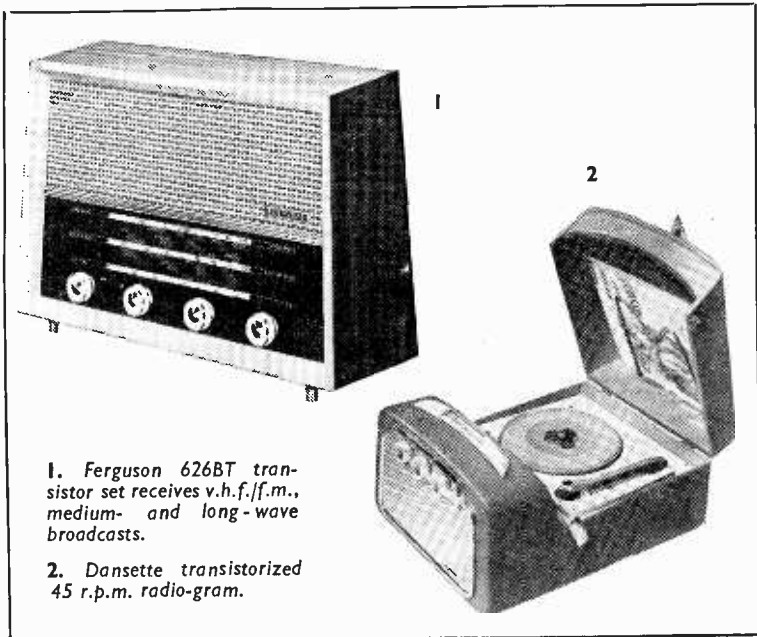

1. Ferguson 626BT transistor set receives v.h.f./f.m., medium- and long-wave broadcasts.

2. Dansette transistorized 45 r.p.m. radio-gram.

**FIDELITY (48)**

To the Argyll series of tape recorders has now been added the Argyll Minor, a twin-track recorder running at 3½ in./sec. A "magic-eye" indicator provides visible check of recording amplitude. It is sturdily constructed and operates from a.c. mains.

Elegantly housed in the modern style is the RG26 radio-gram. It has ample space for record storage, the radio and gramophone compartments are side-by-side, the latter being exceptionally accessible, and the 6-valve radio unit provides for a.m. and v.h.f./f.m. broadcast reception. The gramophone is a 4-speed, auto-changer type. It is an a.c. mains model.

*Fidelity Radio Ltd., 11-13 Blechyn-den Street, London, W.11.*

**FUND FOR THE BLIND (414)**

Visitors to this stand, donated by the organizers, will be given the opportunity of seeing how the blind are able to take their place beside sighted people in industry. This organization makes a collective appeal on behalf of 14 institutions, societies and associations providing services to some 16,000 blind civilians in the Metropolitan area.

*Greater London Fund for the Blind, 2 Wyndham Place, London, W.1.*

**G.E.C. (32)**

A notable addition to this company's products is a v.h.f./f.m. nine-transistor portable receiver. A new miniature a.m. transistor receiver is also introduced. Features of a new a.m./f.m. stereo radio-gram are reflex mounting for its loudspeakers, stereo tape record/replay facilities, and an input position for a second stereo radio channel. New television receivers introduced continue G.E.C.'s slender curved styling and include several which incorporate a v.h.f./f.m. receiver. A chassis and cabinet which are hinged for ease of servicing are a feature of the new BT326 17-in portable television receiver.

*General Electric Co., Ltd., Magnet House, Kingsway, London, W.C.2.*

**G.P.O. (403)**

Radio interference and its suppression, the use of ferrite cores in telecommunications and the part played by the Post Office in linking sound and television studios to transmitters, are among the various aspects of the work of the G.P.O. illustrated on the stand. There is also a careers section where young people can obtain information on the variety of openings available to Post Office trainees.

*General Post Office, Headquarters Building, St. Martin's-le-Grand, London, E.C.1.*

**GALA RECORDS (202)**

Among the disc records shown on this stand is a new "Goldentone" series for children in 6in size (78 r.p.m.) costing 2s 9d each. Also introduced this year is a series of four language courses on 12in, 1.p. records in which is included Russian.

*Selcol Products Ltd., 114-116 Charing Cross Road, London, W.C.2.*

**GARRARD (56)**

A new model in the range of crystal and moving-coil pickups and record turntables is the Laboratory Series Auto Turntable Type A which is a combined transcription and automatic record player. The turntable in this unit has an unusual construction consisting of a sandwich made up out of an inner steel shell to provide a magnetic screen over the motor, a foam polyurethane disc, and a heavy non-magnetic outer shell. Also shown are the well-known 301 transcription turntable, TPA12 adjustable pickup arm, and SPG3 stylus pressure gauge.

*Garrard Engineering & Manufacturing Co., Ltd., Newcastle Street, Swindon, Wilts.*

**GOODMANS (220)**

A new addition to the range of compact loudspeaker systems is the inexpensive AL100. Also newly-introduced is a corner horn enclosure suitable for home construction for which working drawings but not kits are available and which is designed to be used with the Triaxette three-element coaxial loud-

speaker. Also shown are the new Axiom 110 and 112 10-in loudspeakers.

*Goodmans Industries Ltd., Axiom Works, Wembley, Middx.*

**GRAMOPHONE COMPANY (46)**

On show are three-speed tape recorders and mono portable automatic record reproducers. Also displayed is the new E.M.I. high-quality stereo pickup. Special features of the head of this are its very low effective tip mass ( $\approx 1$  mgm) and high lateral compliance ( $7 \times 10^{-6}$  cm/dyne). The arm is balanced both laterally and longitudinally, and the single pivot is viscous damped. The offset angle is chosen to minimize the distortion rather than—as is usual—the tracking angle. The arm incorporates a device for gently raising and lowering it so as to prevent damage to the record.

*Gramophone Co., Ltd., Blyth Road, Hayes, Middx.*

**HACKER (113)**

The main exhibit is the new Herald seven-transistor portable receiver. Interesting features of this are a specially-loaded large (8in  $\times$  5in) loudspeaker, a one-watt push-pull output, and three-position tone control. Sockets are provided for an external aerial for use in a car and for connecting a microphone for using the receiver as a Baby Alarm. Also shown will be a portable transistor record player and radio-gram.

*Hacker Radio Ltd., Norreys Drive, Cox Green, Maidenhead, Berks.*

**HEATHKIT (112)**

New kits on show include mono and stereo tape record/replay amplifiers as well as a transistor portable receiver. This latter covers the short and trawler as well as the usual medium and long wavebands, and has a 500mW push-pull output and relatively large (7in by 4in) speaker. The tape amplifiers can be matched to high- or low-impedance heads and feature a push-pull bias supply with a three-position level control for obtaining optimum results from any make of tape. New instrument kits include an r.f. generator covering from 100kc/s to 100Mc/s on fundamentals, as well as a valve grid-dip meter and its transistorized near equivalent.

*Daystrom Ltd., Gloucester.*

**"HIS MASTER'S VOICE" (33)**

The Model 1421 is a new a.m./f.m. transistor table receiver notable for employing an r.f. stage for both a.m. and f.m. broadcast reception. It has 9 transistors, 4 diodes and a 1-watt output stage feeding an 8  $\times$  5in elliptical loudspeaker. V.h.f. dipole and ferrite-rod aerials are included in the set.

The tuner in the Model 1910 television receiver, new this year, includes coils for all 13 channels and

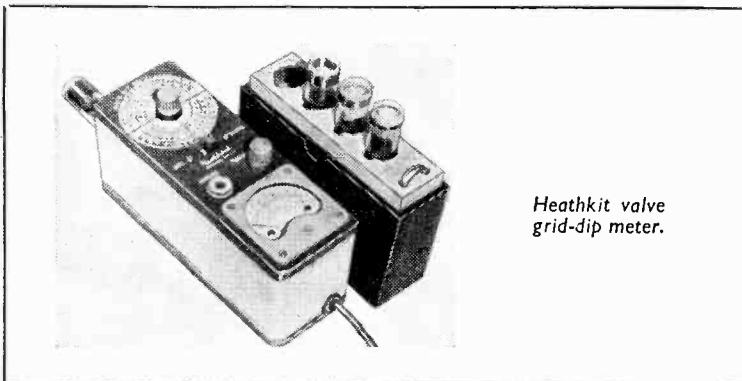

Heathkit valve grid-dip meter.

"H.M.V." Model 1421  
AM/FM receiver



with 4 on immediate call by means of piano-type key switches. A 17in, 110° tube, printed circuits and a 5-in front-facing loudspeaker are employed. A set of matching legs is available. There is also a 17in (110°) portable TV set with all 13 channels on call by means of an orthodox rotary switch located on one side of the very slim-looking cabinet.

*British Radio Corporation Ltd., "His Master's Voice" Radio and Television Sales, 21 Cavendish Place, London, W.1.*

#### CHRISTOPHER HOBDAY (221)

Wholesale distributors to the radio trade this firm is showing a representative range of receivers, sound reproducing equipment and associated apparatus supplied by them.

*Christopher Hobday Ltd., 98-102 Broadway, Leigh-on-Sea, Essex.*

#### HOME MAINTENANCE (118)

Servicing of radio, television and other domestic appliances for the trade is the function of this organization. On Stand 118 will be found a trade enquiry bureau.

*Home Maintenance Ltd., Blyth Road, Hayes, Middlesex.*

#### HUNTS CAPACITORS (49)

This company manufactures capacitors for all radio, television and electronic purposes. On show will be a wide range of both miniature and normal-sized units made by a variety of techniques, recent introductions being "Duolectric" metallized paper and plastics film units in metal or moulded casings and "Huntalitic" tantalum electrolytic capacitors of dry construction. Also shown will be many types of capacitors developed for use with printed wiring.

*A. H. Hunt (Capacitors) Ltd., Bendon Valley, Garratt Lane, London, S.W.18.*

#### I.T.A. (74)

This joint display by two programme contractors (Associated TeleVision and Southern Television), Independent Television News and the I.T.A., includes an O.B. unit with three cameras which are being used for closed-circuit transmissions within the exhibition. It also serves as an

information centre for independent television.

*Independent Television Authority, 14 Princes Gate, London, S.W.7.*

#### J-BEAM (5)

Well-known for their slot aerials for Band III, this company have devoted considerable research to reducing the unsightliness of television aerial arrays. Possibly the most striking examples of the outcome of this research are the combined Band I/III Double Beam 4/2, Omnibeam 4/2 and New J.One aerials; although in the New J.One the familiar slot construction has disappeared. Three more new aerials on show will be a telescopic car-radio aerial for transistor portable receivers: this is temporarily attached to the car by p.v.c. suckers, the Indoor Omnibeam—a wideband (Channels 6 to 13) Band-III slot combined with a telescopic Band-I element to cover Channels 1 to 5, and the "Marine Omnibeam" for the reception of television on ships.

*J-Beam Aerials Ltd., Westonia, Weston Favell, Northampton.*

#### KERRY'S (19)

This exhibit comprises a representative display of the various proprietary makes of radio and TV receivers, audio equipment, test gear and accessories, which, as wholesale distributors, they supply to the radio trade.

*Kerry's (Great Britain) Ltd., Warton Road, Stratford, London, E.15.*

#### KOLSTER-BRANDES (22)

The Kolsterama, Consort and Sovereign television receivers to be shown use a new 23-in c.r.t. with right-angle corners so that the complete picture as "seen" by the camera is displayed without the corner cutting inevitable when the whole screen of a more conventional c.r.t. is used. Other apparatus to be shown will include 17-in television set, radio receivers for v.h.f./f.m. and a.m., radio gramophones, record players and a tape recorder.

*Kolster-Brandes Ltd., Footscray, Sidcup, Kent.*

#### LABGEAR (25)

Television and v.h.f./f.m. aerials, accessories, amplifiers; intercom-

munication equipment and test instruments will be shown on this stand.

ECC88 valves are used in the E5053 and E5054 amplifiers, both of which are dual-channel (Band I/III) types providing gains of 15-18dB and 35-38dB respectively.

The intercommunication equipment exhibited will include instruments using the mains wiring alone for interconnection.

*Labgear Ltd., Willow Place, Cambridge.*

#### LEE PRODUCTS (55)

The wide range of products shown includes public address equipment and the Dulci and Elpico ranges of high-fidelity mono and stereo amplifiers and pre-amplifiers. Also shown are five- and fifteen-watt guitar amplifiers for which additional units for producing a tremolo effect are available. Elpico column-shaped loudspeaker enclosures as well as cabinets for housing a record turntable, pickup, pre-amplifier and amplifier are also on show.

Components exhibited include a very wide range of car aerials as well as resistors and capacitors.

*Lee Products (Great Britain) Ltd., Elpico House, Longford Street, London, N.W.1.*

#### LE GREST (122)

This firm manufacture television tables and trolleys of various kinds. There is shown a range of tables with and without lower shelves for programme journals and there are models with special non-slip tops and easy-running casters.

*Le Grest and Co., 58 Fairfield Street, London, S.W.18.*

#### LIFEGUARD (30)

On this stand C.R.T. Ltd., a newcomer to the new-tube industry, will be showing representative samples from the Lifeguard range of completely new cathode-ray tubes for television.

*Cathode Ray Tubes Ltd., Factory Centre, Kings Norton, Birmingham 30.*

#### LINGUAPHONE (109)

Language courses on gramophone records, many of them now on micro-groove discs, are available from the Institute.

*Linguaphone Institute Ltd., 207-209 Regent Street, London, W.1.*

#### MARCONIPHONE (47)

The new 17in (110°) portable television receiver (Model VP168) shown this year is housed in an attractive case giving the impression of even greater "slimness" than its modest front-to-back measurement of 12½in. Coils for all 13 channels are included and special attention has been given to achieving maximum r.f. gain with minimum noise. Printed circuits are used except for the tuner and mains wiring.

Among the valve-type receivers is a

new a.c./d.c. long, medium and v.h.f. sound receiver (Model T89DA) with provision for feeding into a tape recorder, also a 4-speed auto-radio-gram (Model RG86) which caters for v.h.f./f.m. as well as medium and long wave broadcasting.

The latest transistor portable is the Model T85B employing 6 transistors and a 400mW push-pull output stage feeding into a 5in (round) loudspeaker  
*British Radio Corporation Ltd.,  
Marconiphone Radio and Television  
Sales, 21 Cavendish Place, London,  
W.1.*

#### MARKOVITS (120)

This stand is devoted to a representative display of metal nameplates, receiver and equipment emblems and various kinds of metal embellishments supplied by this firm to the radio industry.

*I. Markovits, 8 Golden Square,  
London, W.1.*

#### McMICHAEL (53)

The new television sets introduced this year are notable for at least two features of unusual interest. One is provision of remote control of brightness, volume and on/off while the other is the inclusion in the set of a light-sensitive cell (cat's eye) which automatically adjusts the contrast to compensate for changes in the room lighting. The remote control, or armchair, unit can be located up to 15ft from the set.

The new sets include a 17-in (110°), model in either a transportable (Model MP27) or "static" type cabinet (Model M75T) both similar electrically and providing for v.h.f. broadcast reception. A 21-in version is also available and it is made as a contemporary console.

To complete the range of new sets is a 17in portable, the Model MP20.

The sound radio sets include stereo auto-radio-grams and transistor portables.

*Radio and Allied Industries Ltd.,  
Langley Park, Slough, Bucks.*

#### METROPOLITAN POLICE (402)

This is the first time for some years that the Metropolitan Police have provided a display at the Radio Show. Replicas of a radio operator's position at New Scotland Yard, a "999" operator's position and that of an Interpol operator—who by international agreement still uses a morse key—are being shown. Various mobile radio installations are also on show. An interesting feature of the 7-channel transmitter-receiver installed in the Traffic Accident Car is that it uses the r.f. output valve (a double tetrode) as a class B a.f. amplifier to feed the loudhailers.

*Metropolitan Police, New Scotland  
Yard, London, S.W.1.*

#### MULLARD (40, X19)

The interior of Stand 40 is given over to the presentation of "Mullard

drama" on a continuous showing principle. Mullardrama is part colour film (starring Jon Pertwee), part display (starring Mullard products for the radio and television industry) and the theme is the difference between the old and the new means for providing entertainment by electronic techniques.

The Home Constructor Centre this year is at Stand X19. Here circuit diagrams and constructional details for Mullard designs will be available.

*Mullard Ltd., Mullard House,  
Torrington Place, London, W.C.1.*

#### MULTICORE AND MULTIMUSIC (71)

This combined stand will display both the well-known Multicore solder products, such as the Savbit alloy for prolonging the life of soldering iron bits, as well as the new Reflectograph tape recorders, one of which is for two tracks and the other for four. Both of these new recorders use the same mechanical deck which provides tape speeds of 3½ or 7½in/sec and which has the unusual feature that a single potentiometer control provides variable-speed fast forward and rewind. Separate record and replay amplifiers are used.

*Multicore Solders Ltd., Maylands  
Avenue, Hemel Hempstead, Herts.*

#### MURPHY (23)

The TR1, Murphy's first tape recorder, will be on show. Using the Garrard cassette-loading deck, to whose controls the recorder switching is ganged for simple operation, the TR1 has a "magic-eye" record-level indicator which operates before the tape can be set in motion.

Among the new radio-grams will be the portable A512R. Instead of the more usual m.w. and l.w. radio an f.m. tuner is provided. A stereophonic turnover cartridge is already fitted—for stereo reproduction the companion amplifier/loudspeaker unit is plugged-in. Another new radio-gram features a return almost to the flat baffle for its loudspeaker mounting (A592R).

The television receivers shown will include 17- and 21-in models in both "standard" and "luxury" classes, both with and without v.h.f./f.m. radio. Those receivers with f.m. facilities retain the automatic frequency control feature introduced last year so that switch programme selection, without fine-tuner fiddling, is provided.

A new transistor portable receiver, the B483, has a plastics cabinet of "Forticel", which possesses shock-resisting qualities.

*Murphy Radio Ltd., Welwyn Garden  
City, Hertfordshire.*

#### NEV (218)

The Nottingham Electronic Valve Company claim that their cathode-ray tube reconditioning equipment is the first to be shown at a National Radio Show. The apparatus includes

semi-automatic machines suitable for the dealer who wishes to recondition up to 25 c.r.t.s per week and the plant can be expanded to deal with up to 1,000/week.

*Nottingham Electronic Valve Co.  
Ltd., Kenrick Street, Netherfield,  
Nottingham.*

#### PERDIO (41)

The wide range of transistor receivers on show includes the Continental. Special features of this are a loudspeaker as large as 8in by 5in, a one-watt push-pull output with bass boost to partially compensate for the small cabinet size, inclusion of the 70-200 metres trawler waveband, and a selectivity which automatically decreases as the station strength falls so as to minimize the signal-to-noise ratio. New transistor receivers which it is hoped to introduce include one for the v.h.f./f.m. band and another giving continuous coverage of a.m. from 11 to 570 metres as well as the long wave band.

*Perdio Ltd., Perdio House, Bonhill  
Street, London, E.C.2.*

#### PERTH (205)

The "Home and Away" radio-gram is a combination of transistor a.m. radio receiver and, in a radio-gram cabinet, a mains-powered turntable and amplifier to which the transistor receiver can be attached as a tuner unit. The transistor receiver can, of course, be removed and used separately as a portable.

Four versions of a wholly mains-powered radio-gram will be shown: a.m., a.m./stereo, a.m./f.m. and a.m./f.m./stereo. All Perth radio-grams have polished wood backs so that they are freed from the limitation of having to be stood against a wall.

Two record players (single-channel and stereo) a tape recorder (Clarissa Mk. 3) and a transistor portable receiver will complete the display.

*Perth Radios Ltd., Marten House,  
39/47 East Road, London, N.1.*

#### PETO SCOTT (27)

Seven types of television receiver will be shown on this stand including portable, table and table-with-f.m. models as well as the Fanfare tape recorder. Two of the television receivers will be seen for the first time at the show—a 21-in model with twin loudspeakers and side controls and a 17-in. set which is described as "extra-slim" with keyboard tuning.

*Peto Scott Electrical Instruments  
Ltd., Adlestone Road, Weybridge,  
Surrey.*

#### PHILCO (45)

Following the trend for picture-on-the-wall television, started last year with the "Telarama", Philco have introduced this year the "Picturama"—a 17-in. receiver using the short-neck 110° c.r.t.—which can be hung on the wall. This set is not



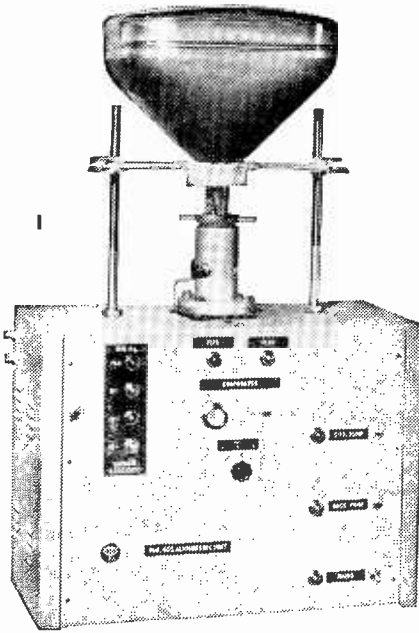

1. Aluminizing machine from Nottingham Electronic Valve Company's "400" c.r.t. reconditioning plant.

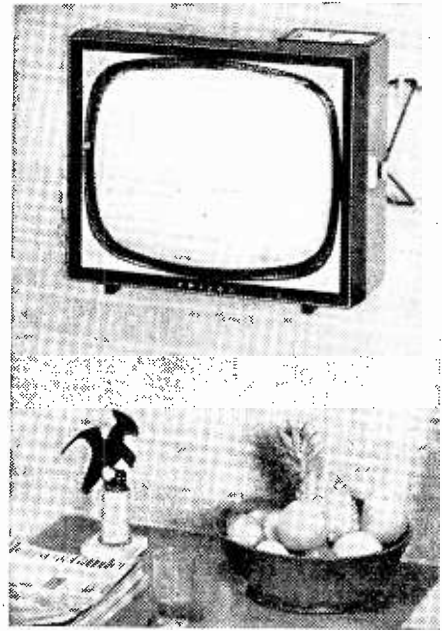

2. Picturama 17-in TV receiver by Philco hangs on the wall or uses its mounting bracket as a table stand.

3. Model VPI68 Marconiphone 17-in portable television receiver.

4. McMichael Model MP20 17-in portable television receiver.

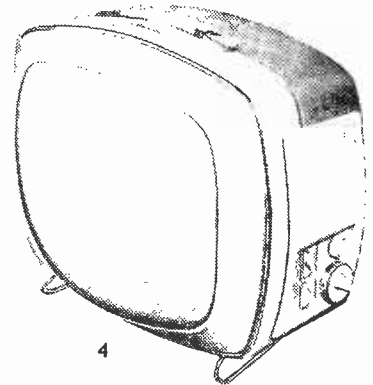
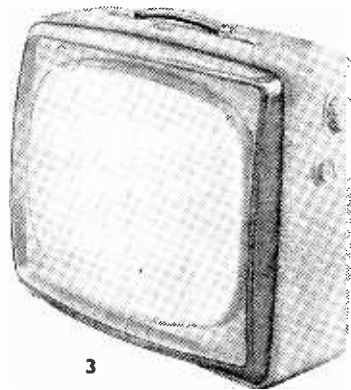

"just a pretty face"—inside information is given to the serviceman by completely colour-coded sub-assemblies, so that, Philco claim, most servicing can be carried out without reference to a service manual.

Other new designs to be shown will be radio-grams, record players, radio receivers and, in addition to the Picturama, television receivers.

Philco (Great Britain) Ltd., 30/32 Gray's Inn Road, London, W.C.1.

#### PHILIPS (10)

Recent introductions by this company include an a.m./f.m. receiver, a de luxe version of the Philette transistorized receiver which has a detachable handle for converting it from a portable to a table radio, an automatic version of the Disc Jockey stereo record reproducer, and an a.m./f.m. stereo radio-gram in which the loud-speakers are mounted at the

ends of the cabinet and angled outwards. Well-known features of this company's range of television receivers are the use of a hinged chassis for ease of servicing, and side mounting but forward angling of the loud-speaker.

Philips Electrical Ltd., Century House, Shaftesbury Avenue, London, W.C.2.

#### PILOT (11)

The "Spacemaker" range of television sets introduced last year is continued with little change; this includes 17in. and 21in. models in table and portable form with and without v.h.f. radio channels.

Among the sound reproducing apparatus is a lightweight portable stereo record player with 4-speed auto record changer and embodying two detachable loudspeakers which form the lid of the player. There is

also a transistor portable which can be operated from its self-contained aerial or a car aerial. It covers medium and long wavebands.

Pilot Radio and Television Ltd., Television House, Eastcote, Ruislip, Middlesex.

#### PITRIE (108)

This stand will hold a display of reconditioned television cathode-ray tubes and function as a trade enquiry office.

Pitrie Ltd., 21 Noel Street, London, W.1.

#### PLESSEY (73)

This stand is primarily an office where design engineers, representatives of manufacturing organizations and business associates from abroad can discuss immediate and future requirements with members of the Plessey organization. Available for their



inspection are examples of this firm's current and newest products.

*Plessey Co. Ltd., Vicarage Lane, Ilford, Essex.*

**R.G.D. (29)**

Among the wide range of television and radio receivers, radio-grams, record players and a tape recorder to be shown will be five models introduced for the exhibition. Of particular interest will be the Model 612 television receiver with its press-button tuner and the 204 a.m./f.m. radio-gram which is styled in the modern long, low look.

For the connoisseur of recorded and broadcast sound the Model 418 radio-gram will be shown. This uses a Goldring variable-reluctance pick-up and is fitted with an integral 6.5W amplifier and five loudspeakers, the bass chamber using an acoustic resistance unit. For stereo a second amplifier/loudspeaker combination is added, but the controls are grouped in the original console.

*Radio Gramophone Development Co. Ltd., Eastern Avenue West, Romford, Essex.*

**R.S.G.B. (411)**

The Radio Amateur Emergency Network is featured on the Society's stand on which will be found a wide variety of amateur transmitting, receiving and test equipment. There is also a selection of the books and pamphlets issued by the Society, including the new editions of the "Amateur Radio Call Book" and "A Guide to Amateur Radio."

*Radio Society of Great Britain, New Ruskin House, Little Russell Street, London, W.C.1.*

**R.T.R.A. (201)**

A reception centre is provided for members of the Association and an information bureau for the general

public where visitors may obtain a list of R.T.R.A. members in their particular district.

*Radio and Television Retailers' Association, 15/17 Goodge Street, London, W.1.*

**RECORD HOUSING (116)**

The motto of this company is "Hi-Fi Furniture is our Business" and this puts in a nutshell what will be seen on their stand. Among the cabinets for records, equipment and loudspeakers added to their range since last year's show will be found examples of the long, low trend (Polonaise de Luxe) and the more traditional approach to cabinet design (Delius).

*Record Housing, Brook Road, London, N.22.*

**REDICORD (123)**

This firm is showing a range of stereo record players in portable form and also for mains operation at

home. One model "The Nevin" is designed with the small-flat occupier in mind as it provides, in compact form, a stereo record player, a tape recorder fitted with a Garrard magazine tape deck and integral twin loudspeakers. There is a portable tape recorder and "The Calypso" transistor 4-speed lightweight record player.

*Redicord Ltd., 46 Frith Street, London, W.1.*

**REGENTONE (59)**

The SRG15 seven-valve stereo radiogram to be shown is a one-box design in which the necessary separation between the loudspeakers is achieved by mounting them at the ends of the four-foot wide cabinet. Its companion new single-channel model, the ARG14, is wired for stereo conversion.

Among the television receivers which will include models with f.m.



1. Press-button tuning is a feature of the R.G.D. Model 612 television receiver.

2. Sobel stereophonic radio-gram, Model SG670

3. New stereo a.m./f.m. radiogramophone from Regentone has divided top covering the record changer (Model SRG15)

radio, will be two new sets, one of which, the Model 17-18, is fitted with the "Fingermatic" press-button tuner for instant selection of the desired channel.

Other products to be exhibited will include a.m. and f.m. radio receivers, record players and a tape recorder.

*Regentone Radio and Television Ltd., Eastern Avenue West, Romford, Essex.*

#### ROBERTS (70)

The R200 transistor portable is the latest addition to this firm's range of small portables. It is a two-band a.m. set, embodies a printed circuit with 6 transistors, two being a push-pull output pair, and a diode. The 5in loudspeaker is large for a portable and it has a magnet with the exceptionally high flux of 13,000 gauss. Battery economy is one of its main features, the consumption being only 20mA from the 9-V battery. Provision is made for operating the set, which has a ferrite-rod aerial, from a car aerial if required.

*Roberts' Radio Co. Ltd., Creek Road, East Molesey, Surrey.*

#### ROLA CELESTION (213)

A very comprehensive range of loudspeakers is displayed. Those for set manufacturers include several elliptical types as well as circular ones with diameters ranging from 2½ to 15in. Those for public address purposes include re-entrant horns and column units. Among the loudspeakers for special purposes are some which are flame proof.

*Rola Celestion Ltd., Thames Ditton, Surrey.*

#### ROSE PROJECTS (119)

Television tables, record storage cabinets and showroom display stands are a speciality of this firm. Included among their TV tables is a novel design known as "Long-Tom" measuring 42in × 21in and having a revolving platform at one end for the TV set which can be locked in any desired viewing position.

*Rosa Projects Inc., Bourne End, Bucks.*

#### S.T.C. (14)

Special valves for industrial applications, transistors, tunnel diodes, tantalum capacitors and many other components occupy much of the space on this stand. There is a range of quartz crystals including some triple crystal units in a single glass envelope for crystal control of the mixer oscillator in v.h.f./f.m. broadcast sets, also the FST1/4 silicon rectifier for h.t. supply in television sets. Two are required in series on 200/240V a.c. mains for half-wave rectification. The rated maximum d.c. output is 500mA.

*Standard Telephones and Cables Ltd., Connaught House, Aldwych, London, W.C.2.*

#### SLINGSBY (31)

Wheeled trucks and trolleys designed especially for handling television sets, radio-grams and the heavier kinds of audio apparatus in dealers' showrooms and warehouses, as well as loading and unloading equipment for vans, are shown on this stand.

*H. C. Slingsby Ltd., 89-97 Kingsway, London, W.C.2.*

#### SLOSS (102)

This company will be exhibiting television aeriels, accessories, and coaxial cables. The "Regal" aerial arrays are coated with a plastics film in various decorative colours to provide protection against corrosion.

Band-III aeriels have the "Ben-Nevis" diplexer built-in and are designed to be added to an existing Band-I installation. Provided with a 6ft tail of coaxial cable, the installer removes the existing cable from the Band I aerial, connects it to the Band III aerial and connects the tail to the Band I aerial.

*Andrew Sloss, Belmont Works, Belmont Site, Lewis Street, Stranraer, Scotland.*

#### SOBELL (64)

The new 21in television console, Model SC3", is fitted with two forward facing loudspeakers, a "magic eye" automatic control of contrast actuated by the degree of lighting in the room and an armchair unit on a 15ft plug-in lead giving remote control of on/off, brightness and volume. This set also provides v.h.f./f.m. reception.

There is a 17in model (110°) in transportable and table styles, TPS781 and T279 respectively, also two portables, a 21in Model T293 and a 17in, Model TP5710. Both are fitted with chassis which swing outward on a hinge for servicing when the back is removed.

Their new AM/FM stereo radiogram Model SG670 has a 4-speed auto changer and built-in twin loudspeakers. Ample space is allowed for record storage and for programme periodicals.

*Radio and Allied Industries Ltd., Langley Park, Slough, Bucks.*

#### SOUTHGATE TUBULAR PRODUCTS (210)

Manufacturers of tubular-metal stands and industrial furniture, this firm is showing a selection of its products especially suitable for window and showroom display of radio sets and accessories. Also included is a small display electric turntable claimed to run continuously for one month on two U2 batteries.

*Southgate Tubular Products, 148 Chase Side, Southgate, London, N.14.*

#### STELLA (6)

Four radio models and a record player comprise the show introductions.

Other sets on display will include

radio, radiogramophone and television receiving equipment and a record player which is adaptable for stereo.

The ST562A is the new record player. Portable, it has a stereo amplifier and twin loudspeakers, one of which can be detached for full stereophonic effect. A Philips record changer is used.

*Stella Radio and Television Co. Ltd., Astra House, 121-123 Shaftesbury Avenue, London, W.C.2.*

#### T.C.C. (42)

New developments in capacitors, printed wiring and ceramics will be featured on this stand. For instance, both dry and wet types of tantalum electrolytic capacitors will be shown, together with extensions to the range of miniature dry electrolytic capacitors for transistor applications such as hearing aids. New interference-suppression equipment will include an additional forward-scatter filter for use in the aerial lead of television receivers.

The other exhibits will be the well-established ranges of components for radio, television and electronics industries.

*Telegraph Condenser Company, Ltd., North Acton, London, W.3.*

#### TAPE RECORDERS (3)

A wide range of tape recorders and accessories will be on show. This includes four-track versions of the Sound Studio and Prince recorders as well as a new dictating machine which can be completely remotely controlled. Another new four-track recorder is the Sound Master which features a 14-watt ultra-linear push-pull output, level indication by means of a meter, separate record and replay amplifiers, and facilities for mixing, monitoring and multiple superimposition. Tape accessories include splicers and the Sonocolor range of ordinary and Synchro-Ciné tapes.

*Tape Recorders (Electronics) Ltd., 784-788 High Road, Tottenham, London, N.17.*

#### TELENG (107)

Well known in the television- and radio-relay field, this company will be exhibiting their range of equipment, cables and accessories for wired broadcast distribution, together with test equipment for networks.

One item, the Type U4000 amplifier, for communal or "extended" aerial service is unusual in that it uses transistors, even for the Band III section. This, of course, has the advantage of reducing size, maintenance and power consumption, which is 1.5W from the mains, for a Band-I, -II and -III amplifier of about 40dB gain. Thus, where line powering is used, many amplifiers can be operated from one central

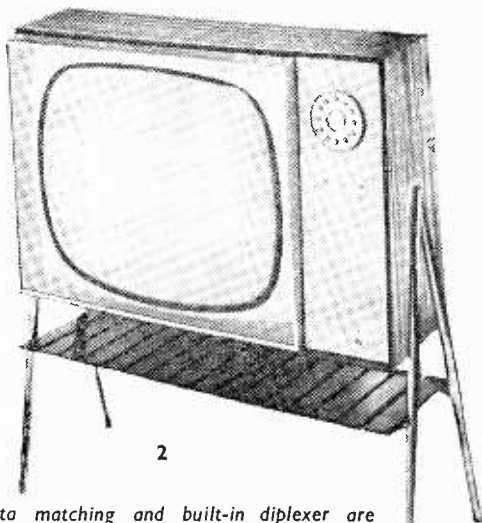
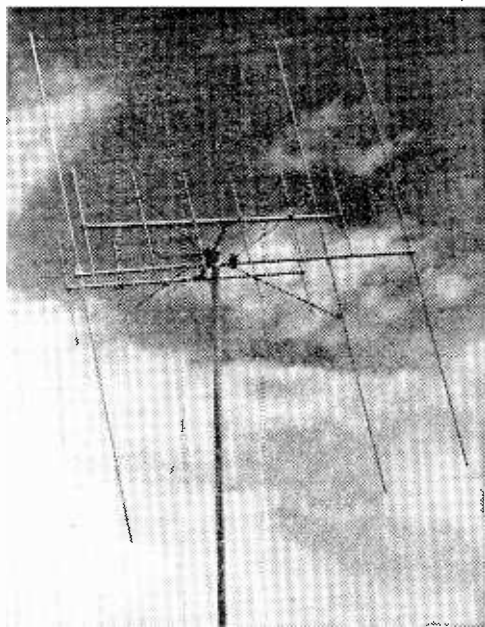

1. Delta matching and built-in diplexer are features of the Telelection Maxima D6 extreme-fringe aerial.  
 2. Ultra "Bermuda" 21-in television receiver with auto-tuning system.  
 3. Teleng's transistor communal-aerial amplifier for Bands I, II and III.

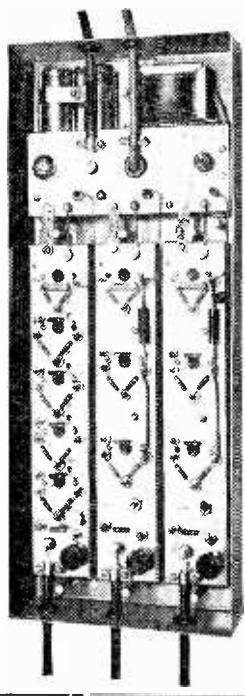

power supply without overloading the coaxial cable.

Teleng Ltd., Church Road, Harold Wood, Romford, Essex.

**TELELECTION (28)**

Additions to this company's wide range of television and v.h.f./f.m. aerials include combined Band-I/III types for secondary- and fringe-area service and dual-band loft aerials. Splayed-H Band-I construction is

used in the Primax-5 and 8 Band I/III aerials and the Maxima D5 and D6 extreme-fringe arrays use delta matching for both Band-I and Band-III sections, which are connected together with a diplexer built-in at the factory. The new "Loftee" attic arrays have telescopic all-channel Band-I aerials and are suitable for both vertical, both horizontal or orthogonal polarizations of the transmitted signals.

Telelection Ltd., Antenna Works, Lynch Lane, Weymouth, Dorset.

**TELESURANCE (9)**

Details of the insurance-maintenance scheme operated by the organization, through dealers who are members of R.T.R.A., are available on this stand.

Telesurance Ltd., 14 Windmill Street, London, W.1.

**TERRITORIAL ARMY (413)**

Equipment typical of that used for training purposes by the 65th Signal Regiment T.A. (formerly No. 1 Special Communications) and the affiliated 328 W.R.A.C. Signal Squadron (for women) is displayed on this stand. Among the trades for which training is provided are radio mechanic and W/T operator.

65th Signal Regiment, T.A., 79/85 Worship Street, London, E.C.2.

**TRIX (37)**

This exhibit consists of record reproducers, tape recorders, public-address and sound-reproducing equipment.

The Model B100 amplifier is rated at 12W output and operates on 12V, consuming 1.5A d.c. It has eight

transistors and the pre-amplifier section has separate inputs and controls for microphone and music, the latter being suitable for tape, gramophone or radio. Provision is made for mixing the input signals; bass and treble controls are included.

Trix Electrical Co., Ltd., 1-5 Maple Place, London, W.1.

**ULTRA (15)**

The new "Bermuda" range of television receivers occupies a prominent place on this stand. Tuning resembles the dialling system of the G.P.O. telephone. To operate it the required television-channel, or v.h.f.-station, selector button is depressed and the whole dial then rotates automatically to the desired position. The auto tuner can also be operated manually. The range includes 17in and 21in tube models in table or console types. The cabinets are designed to accentuate the slimness of the set arising from the use of the new short-neck, 110° tubes.

The range of sound radio receivers includes an a.m./f.m. transistor portable, Model TR81.

Ultra Radio and Television Ltd., Stonefield Way, South Ruislip, Middlesex.

**VALRADIO (114)**

D.C.-to-a.c. and d.c.-to-d.c. converters are a speciality of this firm and examples with outputs between one watt and nearly half a kilowatt will be shown. The units for operation from supplies in the range 6 to 50V use transistors; but for conver-

(Continued on page 449)

sion of d.c. mains to a.c., valve units are available.

For the operation of apparatus using half-wave rectifiers (such as television receivers) d.c.-to-d.c. units are recommended because the unbalanced waveform on a.c. might upset operation of the converter.

Also shown will be the "Mirra-scope" projection television receiver—this produces large-screen pictures up to four feet wide.

*Valradio Ltd., Browells Lane, Feltham, Middlesex.*

#### WALTER (72)

Designed with an eye on the export market the new "Battery-Mains" transistor tape recorder while having portable applications is in all respects a "full-size" machine. It provides for twin-track recording, runs at 3½in/sec, is fitted with 5½in tape spools and is claimed to deliver an undistorted a.f. output of 2W. The recorder is completely self-contained, embodying a mains supply unit, batteries (for 9V operation) and a 7in × 4in elliptical loudspeaker. Shown also are all the current models.

*Walter Instruments Ltd., Garth Road, Morden, Surrey.*

#### WHITELEY (69)

Shown here is a selection of the wide range of audio equipment made by this firm. For stereo reproduction the WB8S amplifier, which comprises a pre-amplifier and power amplifier giving 8W per channel, has been modified for use with both crystal or low-output magnetic pickups, tape and radio. Its pre-amplifier can be used with one of several main amplifiers. Also included is a new 200mW. transistor amplifier using printed circuit technique.

Loudspeakers range in size and type from 1½in and 2½in models, some with plastic chassis and for use in personal portables, to 12in models with 16,000-gauss magnets and new cone assemblies responding to a very wide range of frequencies.

*Whiteley Electrical Radio Co., Ltd., Victoria Street, Mansfield, Notts.*

#### WIRELESS FOR THE BEDRIDDEN (67)

The stand occupied by this society, which provides free radio facilities for needy bedridden, housebound and aged invalids, has been given by the exhibition organizers for the distribution of literature and the collection of donations. The society, which relies entirely on voluntary support, has supplied over 7,000 installations—either sets or relay services—which are maintained free.

"Wireless for the Bedridden" Society, 55a Welbeck Street, London, W.1.

#### WOLSEY (43)

A wide range of television and v.h.f./f.m. radio aerials for indoor (attic and room) and outdoor use will be shown together with a working demonstration of the Wolsey "Vision

Network System" carrier-frequency television and v.h.f./f.m. communal-aerial and relay equipment.

A range of aerials called "Collector-Combine" will be introduced: these aerials feature individual tuning and phasing by means of phasing bars on both Bands I and III.

V.N.S. apparatus can be used for

small block-of-flat systems with as few as half a dozen subscribers up to the provision of relay services for a whole town and the working demonstration will carry four television and four sound channels.

*Wolsey Electronics Ltd., Cray Avenue, St. Mary Cray, Orpington, Kent.*

## AUDIO HALL

#### A.E.I. SOUND EQUIPMENT (308)

Both industrial and domestic high-fidelity loudspeakers, amplifiers and control units will be shown. An unusual feature of the domestic mono control unit is that the low-pass filter cut-off frequency is continuously variable. The loudspeakers include 12- and 18-in direct radiators as well as dual-concentric units in which the centrally-mounted tweeters are horn loaded. Also shown is the Coffee Table Console cabinet suitable for mounting a record turntable, pre-amplifier, amplifier, and radio tuner.

*A.E.I. Sound Equipment Ltd., Crown House, Aldwych, London, W.C.2.*

#### ACOS (310)

Being demonstrated is the Hi-Light pickup with its stereo head. This retains the unusual flexible cantilever arrangement of the mono head and has a needle tip mass of the order of a milligram. The arm produces a very low side thrust (0.02 gm) and is very insensitive to external displacements and vibrations.

Microphones on show include the stereo Mic44 in which two pairs of crystal inserts are used to produce a double figure-of-eight response up to about 8kc/s with the individual element responses extending still higher (up to about 12kc/s).

*Cosmocord Ltd., Eleanor Cross Road, Waltham Cross, Herts.*

#### ALBA (306)

Being demonstrated are two a.m./f.m. stereo radio-grams, a portable stereo record reproducer with the second amplifier and loudspeaker mounted in a separate matching cabinet, and the Duchess tape recorder. An unusual feature of the latter model is the use of two neons to indicate the recording level.

*Alba (Radio and Television) Ltd., Tabernacle Street, London, E.C.2.*

#### BRENELL (311)

A wide range of complete tape recorders as well as separate tape decks and amplifiers will be on show. This includes the new stereo version of the Three Star recorder which has separate modulation indicators for each channel and the very unusual facility of allowing one track to be recorded while the other is being replayed so that synchronized recordings can be made. A very versatile deck is the Mark 5 since it has four

operating speeds and room for four magnetic heads. Also shown is an inexpensive high-impedance three-channel mixer.

*Brenell Engineering Co., Ltd., 1a Doughty Street, London, W.C.1.*

#### DECCA (303)

Demonstrations will be given of the new stereo Decola record reproducer. Special features of this include a multi-directional high-frequency loudspeaker system for providing a large area of good stereo effect, incorporation of the very low ( $\approx 1\text{mgm}$ ) effective needle-tip mass "fliss" pickup, and provision of a micro-lift for gently raising and lowering this pickup.

*The Decca Record Co., Ltd., 9 Albert Embankment, London, S.E.11.*

#### DYNATRON (313)

Stereo will be demonstrated with the aid of the well-known Berkeley  $2 \times 10$  watt a.m./f.m. radio-gram as well as the new Mazurka record reproducer, in each case together with its associated separate second-channel loudspeakers. On show are valve and transistorized four-speed record reproducers as well as the Cordova—this company's first tape recorder. This is a three-speed device.

*Dynatron Radio Ltd., Maidenhead, Berks.*

#### E.A.R. (319)

Among the three new additions to the MusicMaker range of record reproducers is a stereo model in which the second loudspeaker is housed in a detachable lid. Mono and stereo versions of the 1965 and Triple-Four ranges of record reproducers are also on show. Transistorized units exhibited include a four-speed record player and radio-gram as well as a receiver. A tape recorder using the B.S.R. Monardeck is exhibited: it is also hoped to show new models incorporating the Garrard and Collaro tape decks.

*Electric Audio Reproducers Ltd., The Square, Isleworth, Middlesex.*

#### EXPERT (307)

On show are the Stereofon II and III stereo v.h.f./f.m. radio-grams. Both of these use the same  $2 \times 8$ -watt amplifier, pre-amplifier and f.m. tuner, but whereas the Stereofon II uses an autochanger and inexpensive pickup arm, the Stereofon III uses

a transcription turntable and the Expert pickup arm. An unusual feature of the pre-amplifier used in these models is that the tone controls take the form of switched bass boosts and treble cuts. Also exhibited are a column-shaped loudspeaker enclosure and the Master horn-loaded loudspeaker system.

*Expert Gramophones Ltd., 78 Balham High Road, London, S.W.12.*

#### FERGUSON (324)

Demonstrations of a new high-quality radiogramophone, the 658RG, will be given in this room. For details of other Ferguson products, see Main Hall listing.

*Ferguson Radio and Television Ltd., Thorn House, Upper St. Martin's Lane, London, W.C.2.*

#### G.E.C. (322)

An interesting feature of some of the stereo demonstrations is the use of a third central loudspeaker fed with part of both the left and right signals so as to define the central image more accurately. Demonstrations will be given of the small Bookcase loudspeaker and also the Slender Periphonic acoustic "push-pull" two loudspeaker system for reducing low-frequency second harmonic distortion. On show are standard and hi-flux tweeter Presence Units as well as the well-known metal cone speaker and suitable cross-over filters.

*General Electric Co., Ltd., Magnet House, Kingsway, London, W.C.2.*

#### GAINSBOROUGH (301)

Three three-speed tape recorders will be shown on this stand. Special features of the Mark IV are the use of separate record and playback heads and amplifiers, a push-pull erase and bias oscillator, and a meter as the record level indicator.

*Gainsborough Tape Recorders, 189 Northcote Road, London, S.W.11.*

#### GOODMANS (316)

Being demonstrated are the new AL100 and the well-known AL120 compact loudspeaker systems, a new corner horn enclosure suitable for home construction which incorporates the Triaxiette three-element coaxial loudspeaker, and the new Axiom 110 and 112 10in loudspeakers in suitable cabinets.

*Goodmans Industries Ltd., Axiom Works, Wembley, Middx.*

#### GRAMDECK (314)

The Gramdeck utilises the rotation of a gramophone turntable to drive a tape deck, a turntable speed of 78 r.p.m. producing a tape speed of 7½in/sec. Also provided with the deck is a transistor record/replay amplifier and bias supply. Thus recordings can be made from a microphone or from the output transformer secondary of a radio-gram or record reproducer and replayed via the pickup input. Erasure is possible by

means of a permanent magnet. This device thus essentially converts a radio-gram or record reproducer into a tape recorder.

*Andrew Merryfield Ltd., 29-31 Wright's Lane, London, W.8.*

#### GRAMOPHONE COMPANY (323)

Being demonstrated are a range of loudspeaker systems and cabinets suitable for housing a tape deck, record turntable and associated pre-amplifiers and amplifiers. Equipment used includes the new E.M.I. high-quality stereo pickup which features a very low effective needle-tip mass ( $\approx 1$  mgm) and a viscous damped single-pivot arm with a raising and lowering mechanism. Also demonstrated are the Models 557 2×10-watt stereo amplifier and the 556 stereo combined pre-amplifier and very comprehensive tone control unit, an unusual feature of which is the provision of a c.r.t. channel-level monitor.

*Gramophone Co., Ltd., Blyth Road, Hayes, Middlesex.*

#### LUSTRAPHONE (309)

A new addition to the wide range of microphones of all types is a relatively inexpensive stereo ribbon microphone, the VR/65NS. This is similar to the VR65 except that the phase switch and mechanism for relatively rotating the two ribbon elements have been omitted. Also available is a miniature noise-cancelling microphone.

The range of transistorized units includes pre-amplifiers and power-amplifiers as well as a four-channel microphone mixer.

*Lustraphone Ltd., St. George's Works, Regent's Park Road, London, N.W.1.*

#### PHILIPS (320)

Recent introductions by this company in the field of sound reproduction include an a.m./f.m. stereo radiogram in which the loudspeakers are placed at the ends of the cabinet and angled outwards. Also newly introduced is an automatic version of the Disc Jockey Stereo record reproducer in which one of the loudspeakers can be detached from the main cabinet for improving the stereo effect. The output of this record reproducer is 1½ watts per channel.

*Philips Electrical Ltd., Century House, Shaftesbury Avenue, London, W.C.2.*

#### REPS (305)

Newly introduced is the R10 three-speed tape recorder, special features of which are that the frequency response at the slowest speed of 1½in/sec. is claimed to be only 3dB down at 7kc/s and that a meter is used to indicate the recorded signal level. Both two- and four-track versions of this recorder are available. Also being shown are improved versions of the R20, R30 and R40 recorders, a special

feature of which is that each has a push-pull bias and erase oscillator.

*REPS (Tape Recorders) Ltd., 118 Park Road North, London, W.3.*

#### ROLA CELESTION (312)

An interesting unit for high-fidelity sound reproduction is the Colaudio 1550. This consists of a 15in bass unit in the centre of which are mounted two tweeters forming a short column. The high-frequency polar response of this loudspeaker can thus be altered by rotating it so as to rotate this column. Other loudspeakers on show include elliptical units as well as circular models with diameters ranging from 2½ to 15in.

*Rola Celestion Ltd., Ferry Works, Thames Ditton, Surrey.*

#### SYMPHONY (302)

Equipment on show includes two tape recorders, a bass reflex loudspeaker cabinet available in kit form or ready built, f.m. and a.m./f.m. tuners, and mono and stereo combined amplifiers, pre-amplifiers and tone control units. An unusual feature of these last is that the middle as well as the bass and treble frequencies can be boosted. Also exhibited is the Stereophoner, which is claimed to produce an effect resembling that obtained with stereophonic equipment when connected between a single-channel output transformer secondary and two spaced loudspeaker systems.

*Symphony Amplifiers Ltd., 16 Kings College Road, London, N.W.3.*

#### TRUVOX (317)

The main exhibits will be the R6 and R7 tape recorders, an unusual feature of which is that each is provided with an R.I.A.A. compensated pickup input. Other special features of the R7 recorder are that it can record or replay with the tape travelling in either direction, and that it has a ten-watt push-pull output. Both of these models can operate at tape speeds of 7½ or 3½in/sec. Also on show will be the well-known Radio Jack miniature tuners mounted on a jack plug for recording from the local B.B.C. stations.

*Truvox Ltd., Neasden Lane, London, N.W.10.*

#### WHITELEY (304)

In addition to the range of domestic-type loudspeakers there is included here a selection of various industrial type loudspeakers in a wide variety of cabinets including "line source" types for both indoor and outdoor use.

The latest technique in audio component potting in epoxy and polyester resins is exemplified by a selective range of transformers, filters and inductors encased in this form. The range of "breakdown cabinets," which includes bass reflex types, is continued this year.

*Whiteley Electrical Radio Co. Ltd., Victoria Street, Mansfield, Notts.*

# A. D. BLUMLEIN

By M. G. SCROGGIE, B.Sc., M.I.E.E.

**G**ENIUS was defined by Carlyle as, first of all, transcendent capacity for taking trouble. It was analysed by Edison as 1% inspiration and 99% perspiration. These both corrected popular ideas on the subject by emphasizing the part played by hard work. But that 1% is just as essential. If there have been people whose brilliant originality died with them, there were many more whose slogging failed to make up for their lack of imagination. The thinking of most of us is shaped by concepts we have received from others. When the genius comes along, with thoughts that break out into new concepts, his fellows often find him hard to understand. They may even oppose him, because he doesn't conform to their ways of thought. Matters are made worse when, like Heaviside, he is unable or unwilling to make his ideas clear to the less intelligent.

If, as I am convinced, the genius of A. D. Blumlein is not yet widely enough appreciated, that is certainly not the reason. His exposition was exceptionally lucid. The trouble is that so very little of it was published. His contribution to technical literature amounts to little more than two I.E.E. papers, the first shared with Prof. Mallett and the second with several colleagues. (Both of these papers, incidentally, were awarded I.E.E. Premiums.) He was too busy to write. So technical literature is the poorer and his name is seldom seen by his successors.

Then the last few years of his work were shrouded in wartime secrecy and his career was cut short at the early age of 38 in the service of his country. Even that fact was not published until more than three years later, and then only briefly.

Besides this, he avoided rather than encouraged publicity to such an extent that photographs of him are almost non-existent, unless one includes a back-seat view of him addressing the I.E.E. in 1938.

Some originators are commemorated in the name of a device, law or discovery—for example, the Hartley circuit, Ohm's law, and the Hall effect. Unfortunately none of Blumlein's frequently mentioned inventions bears his name. Although it appears here and there in the literature, probably very few even of the workers in the same field, and especially the younger ones, have any idea of how far ahead he was in so many important developments. How many present-day stereophony fans, for example, realize that the system of recording brought on to the market during the last year or two was invented by Blumlein in 1931?

I have therefore attempted a review of the more important of his inventions, as a modest tribute to his memory. Not having had the privilege of knowing Blumlein personally, and lacking close acquaintance with some of the branches of work in which he excelled, it is a regrettably poor one, but I hope better than nothing. Lest my emphasis on technical achievements give the impression of a one-sided individual, it should be mentioned that, notwith-

standing them all, Blumlein was thoroughly human and found time for such relaxations as flying, practical astronomy, enjoyment of music and theatre. I am indebted to a number of his friends and colleagues for encouragement and information readily supplied, notably S. J. Preston and H. A. M. Clark of E.M.I., J. B. Kaye of Painton, formerly of International Standard Electric, and M. van Hasselt of Standard Telephones.

Alan Dower Blumlein was educated at Highgate School and the City and Guilds College, London. It was in January 1925, soon after he had graduated, that he and Prof. E. Mallett read their I.E.E. paper, "A New Method of High-Frequency Resistance Measurement"—a problem which was receiving much attention at the time. Their method was ingenious and potentially very accurate, but proved too complicated to achieve popularity.

At about this time Blumlein began his professional career by joining the International Western Electric

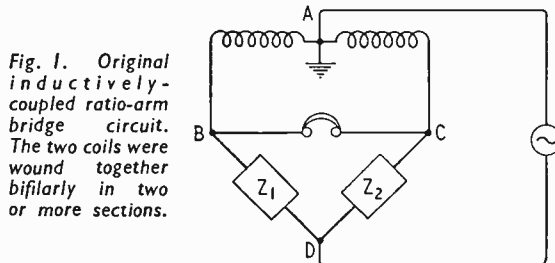

Fig. 1. Original inductively-coupled ratio-arm bridge circuit. The two coils were wound together bifilarly in two or more sections.

Corporation. His work there was mainly on problems of interference in telephone lines, and he soon provided evidence of his exceptional ability and originality in circuit engineering. At least eight patents resulted from this line communication work, the first of which (No. 291,511, in conjunction with J. P. Johns) came early in 1927 and described a method for reducing mutual interference between channels ("cross-talk") in long-distance telephone cable systems. Nowadays long-distance telephony is usually by modulated carrier, with the conversations shifted into separate frequency bands; but then they were at the original speech frequency. To equalize signal velocity over the band, the cables were inductively "loaded" by three-coil units, and these were to blame for much of the cross-talk. Having studied the problem and identified each particular source of cross-talk with great accuracy, Blumlein rearranged the windings to concentrate the unbalances at the points of connection, and then dealt with each of them independently. This method greatly reduced the trouble, and was adopted for all three-coil units from then on. It is, in fact, still used.

In order to carry out this development it was necessary to measure very small differences in impedance. Existing impedance bridges were unsatisfactory in two respects: the ratio arms were insufficiently pre-



cise, and they were too much affected by stray shunt capacitances. So in 1928 Blumlein made a major departure in a.c. bridge technique by using ratio arms consisting of two inductors with practically 100% coupling, as in Fig. 1. This looks at first glance like a conventional a.c. bridge network, so much so that it is those who are familiar with bridges in general who may have most difficulty in realizing that at balance its points B and C as well as A are effectively at earth potential, so there is no p.d. across either ratio arm, and therefore admittances across them have no effect. Blumlein obtained a very close approach to this ideal by using bifilar winding, making the two coils occupy substantially the same position on their iron core. This construction at the same time automatically achieved a 1:1 ratio with much higher precision and constancy than conventional resistance arms.

The patent, No. 323,037, is a short one—only two pages, with no Provisional Specification—yet it clearly and simply explains the principle, the construction both for 1:1 and other ratios, the application of screening, the advantages accruing, and how it can be used to measure direct capacitance between two conductors regardless of capacitances from them to earth. For good measure, it shows how the same device can be used to obtain a precise centre tap for a phantom circuit in telephony. A later specification (334,652) shows an application of the same principle to the simplifying of telephone circuits.

### Unpublished Treatise

As with so many of Blumlein's inventions, his concentration on the work in hand left no time for wider publicity and exploitation, so although possibly the most important step in bridge technique since 1865, when Maxwell applied Wheatstone's circuit to a.c., it went almost unnoticed. Even when, years later (1941), Blumlein wrote an extensive fundamental treatise on the principles implicit in this apparently simple device, it was not published. The substance of it only came prominently to light in 1949, in Part I of an I.E.E. paper by H. A. M. Clark and P. B. Vanderlyn. It is a fine piece of exposition, which the authors acknowledged as being almost verbatim Blumlein. The remainder of this paper was concerned with the application of these principles in a wide-range impedance bridge produced for the Services. An accompanying paper described quite a different application—a low-reading aircraft altimeter, involving the measuring of capacitance changes of the order of one-millionth of a picofarad ( $10^{-18}$  F) in the presence of much larger capacitances to earth. All these developments were patented by Blumlein.

In the discussion of these papers, the first speaker wanted to know why such an attractive invention had been in existence for over 20 years without making more of a mark on bridge design. The explanation was lack of publicity. Since then, inductively coupled ratio arms have come into much use, notably for radio frequencies up to v.h.f. One thinks especially of the B.B.C., C. G. Mayo, and Wayne Kerr in this connection.

Another interesting Blumlein bridge patent is 338,588, which covers a mutual-inductance bridge in which the usual difficulties in varying  $M$  are overcome by means of a resistive potential divider

directly calibrated in inductance (Fig. 2). This was embodied in a valuable and widely used instrument for measurements on balanced-pair carrier cables.

Other inventions of this period concerned submarine cables.

In 1929 Blumlein moved to the research department of the Columbia Graphophone Company. Electrical recording apparatus was then at an early stage of development, having displaced acoustic recording only a few years before. It consisted of a capacitive or carbon microphone, an amplifier based

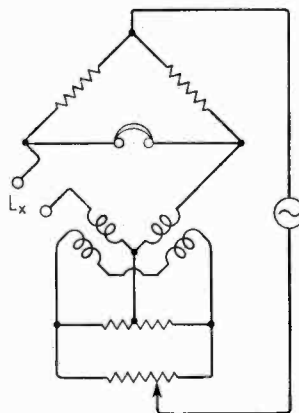

Fig. 2. Mutual-inductance bridge with fixed coils wound toroidally on an iron core. The balance of mutual inductance is shifted to either side of the bridge by a potential divider calibrated directly in inductance of the unknown  $L$ .

on public address practice, and a moving-iron cutter—satisfactory for the transition period, but far from perfect. A team was working on an improved system, and though lacking in experience of sound recording Blumlein soon grasped the principles of electromechanical transducers and made a major contribution to the effort, notably with a moving-coil microphone, an equalized amplifier and a moving-coil cutter. He showed how to match impedances by reducing the length of the cutter arm, and to eliminate the effects of mechanical resonances by electrical circuits with parameters the inverse of those of the mechanical "circuits." For this treatment to be effective, the system had to be designed for a very high electromechanical coupling factor. The first records were made with this equipment in 1930 and set a new standard of fidelity.

At the same time, with P. W. Willans, he showed how to place the needle in relation to the armature of a gramophone pickup so as to raise its resonant frequency to a maximum.

Next year the Columbia and H.M.V. companies merged to form Electric & Musical Industries Ltd.—E.M.I.—and the new recording gear was adopted as standard by the combine. Blumlein continued to work on it, and by improving the sensitivity of the cutter reduced the size of the amplifier sufficiently for portable use. He also extended the possible frequency range to 10 kc/s, but surface noise due to the record materials then available prevented full advantage being taken of this.

### Two-channel Stereophony

At the same time Blumlein was thinking a lot about stereophony. Experiments in two-channel sound transmission had been made as long ago as 1881, using headphones. By the time we are considering, however, there was clearly no commercial



future for headphone listening. Loudspeakers had displaced them in the home, and the "talkies" had established themselves in the cinema. The problems of monophonic reproduction were quite enough for most people. But not for Blumlein. The multiple-speaker method is the obvious approach to practical stereophony and in the years following was adopted in America for experimental demonstrations and the public showing there of Disney's *Fantasia*. It was found that the ideally vast number of channels required for it could be reduced to three, with acceptable results. But even before this Blumlein had evidently decided that three was one too many, and so he tackled the problem of achieving satisfactory spatial reproduction with only two loudspeakers. Characteristically, he began by thoroughly working out for himself the principles involved. Now, 28 years later, with stereophony a household word, there are still people claiming to be technical who suppose that the two loudspeakers are analogous to the two earphones in the earlier experiments. But Blumlein saw clearly that both speakers communicate with both ears, thereby setting a very difficult—one might almost declare impossible—problem. His solution, based on the theory that directional hearing at low frequencies depends on time difference and at high frequencies on intensity difference, was much more subtle than it looks at first sight, and depended on the sum and difference of the outputs from the two microphones. By this means, results equivalent to cardioids pointing in opposite directions were obtained using omni-directional microphones: a remarkable achievement.

Being the first to make a serious attempt at stereophony with loudspeakers, Blumlein had the field to himself, and his patent (No. 394,325) runs to 22 pages and has 70 claims! His system was intended primarily for improving motion picture sound, but other applications, such as domestic records, were included. In almost every respect this patent was more than 20 years ahead of its time.

original 45° disk track has now been adopted throughout the world for stereophonic records, at least one make of which is produced with a cutter of a type shown in his patent.

Rather ironically, the first practical application was one *not* envisaged when the patent was drawn up; its techniques were adapted by Blumlein for better sound location of aircraft during the 1939-45 war, and some thousands of this type of equipment were produced.

## Television

Even before his stereophony patent appeared in print, Blumlein's enthusiasm had been directed into another channel. Soon after the formation of E.M.I., the new company began a full-scale programme of television development. H.M.V. had already demonstrated moderately high-definition pictures (150 lines) using a mechanical system, and the first question was whether to continue along this line or venture into the unknown towards an electronic system. Although it is obvious now that the right answer was the one actually given, the number of unsolved problems that were thereby accepted must have looked pretty appalling. For one thing, the cathode-ray tubes of the period were gas-focused types that went out of focus if the beam current was varied. There was no electronic camera. Even the more familiar items such as amplifiers, transmitters and aerials had to be developed afresh to deal with signals of unprecedented bandwidth. In this connection, another bold decision, made by the E.M.I. Director of Research, I. Schoenberg, was to go far beyond the Television Advisory Committee's requirement of 240 lines—beyond anything that receivers could have been expected to handle fully for some time to come—by adopting a 405-line standard. Again, the rightness of the choice has been proved by events, for after more than quarter of a century of rapid change this same standard continues to give satisfaction and has been accepted in 10 million British homes.

There was therefore plenty of work for the development team, and no time for mistakes. The story is told by S. J. Preston in a Television Society paper, "The Birth of a High Definition Television System."† Blumlein's contribution displayed his characteristics—grasp of essential principles, foresight, versatility, originality, soundness of engineering and insistence on "designability." He would reckon a few extra components well spent if they enabled him to design a circuit on paper with confidence that any number of sets made up from the design would work as intended. It is significant that the E.M.I. equipment of the Alexandra Palace Station, almost every part of which owed something to Blumlein, made straight up from drawings to begin the world's first public high-definition service in 1936, was still in use in 1950.

One of his first developments was a highly original scanning system. Contemporary practice charged a capacitor slowly through a resistance and discharged it quickly through a thyatron, the capacitor voltage being applied to the deflection plates of a c.r. tube. Blumlein's patent 400,976 of April 1932 specifies a simple hard-valve circuit (Fig. 3) to produce a linear

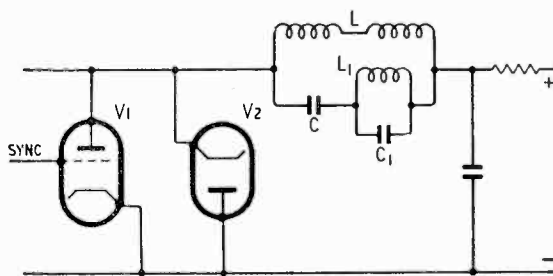

Fig. 3. Early television sawtooth current generator circuit, in which during the working stroke current flows through deflecting coils L and valve V1. The flyback is generated by a half-cycle of oscillation at the frequency of L and C, and is terminated by V2.  $L_1$   $C_1$  curbs any tendency to oscillate at half working frequency.

At that date, and for years to come, shellac-loaded disks and steel needles were in use, but Blumlein advised a material of the nature of cellulose acetate, and a sapphire point as is now standard. The system as a whole was commercialized 25 years later,\* at first with tape recording, but Blumlein's

\* See "The 'Stereosonic' Recording and Reproducing System", by Clark, Dutton and Vanderlyn, *Proc.I.E.E.*, Sept. 1957, pp. 417-432.

† *Journal of the Television Society*, Vol. 7, No. 3 (1953).

sawtooth current for magnetic deflection. The valve V1 is initially conducting, and current grows linearly through the coils L, until a sync pulse cuts off V1. The circuit LC then performs a half-cycle of oscillation at a comparatively high frequency, forming the flyback. Further oscillation is prevented by conduction of V2, which limits the rate at which current through L (now negative) can decrease. L, C1 was included to suppress a waveform component at half scanning frequency.

The origin of negative feedback is invariably attributed to H. S. Black in *B.S.T.J.*, January 1934. This is strange, for a number of earlier references can be found. For instance, Patent No. 425,553 of Sept. 1933, by Blumlein and H. A. M. Clark, specifies it by name for reducing the output impedance of pentodes, as in Fig. 4, and gives the now familiar formula for output impedance:

$$\frac{R_a}{1 + \mu k}$$

where  $k$  is the fraction fed back, now commonly denoted by  $\beta$  or  $B$ .

Considerable confusion has been caused by later writers, led by Black, who used  $\mu$  in identical formulae to mean amplifier voltage gain, instead of correctly as above to mean valve amplification factor.

Negative feedback was mentioned even earlier in a patent of American origin for linearizing sawtooth

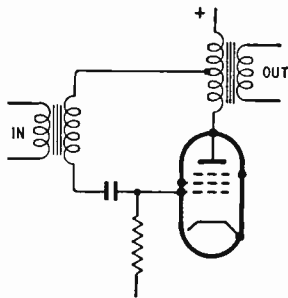

Fig. 4. A pre-Black negative - feedback circuit, designed to reduce the output impedance of pentodes.

current waveforms in frame scanning. Blumlein substantially improved on this with a circuit (Patent No. 479113 of 1936) which is the one commonly used to this day—Fig. 5.

A form of negative feedback that especially appealed to him was the cathode follower. He did not actually originate this configuration, but was the first to appreciate its great value, particularly in

Fig. 5. Blumlein circuit for linearizing frame scanning by use of frequency-selective feedback.

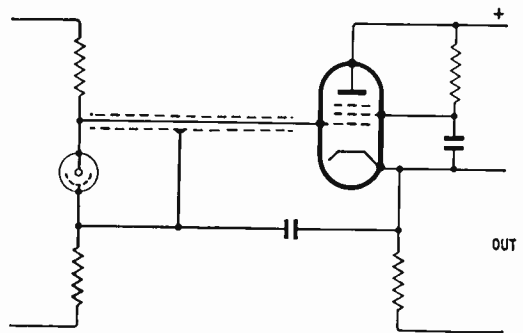
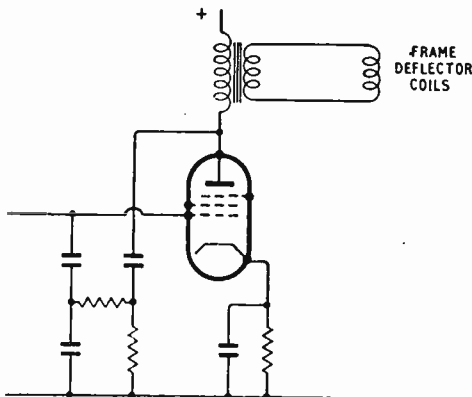

Fig. 6. Reduction of input capacitance by cathode follower (1934).

television. His specification 448,421 of 1934 sets forth with characteristic clarity how by virtue of its very low input capacitance it can be used to advantage in connecting a high-frequency high-impedance source such as a photocell to an amplifier. Furthermore, it anticipated by 15 years the discovery that it can be used as in Fig. 6 to eliminate almost entirely the shunt capacitance of the source and connecting lead. Note, too, the screened coupling; long after this, people were still saying that pentodes were unsuitable for cathode followers!

Television, with its wide signal frequency band down to zero, introduced difficult amplifier problems. It was impracticable to use d.c. couplings throughout the transmitting and receiving chain; but the trick of d.c. reinsertion or restoration, making use of the constant level of synchronizing signals, had been devised. It looks quite a simple technique, but Blumlein and his colleagues had to do considerable work to make it practical, and some of the most involved specifications relate to this development. In particular, "clamping" at an intermediate black level was due to them. The whole thing was tied up with the television waveform, which necessitated a great many irrevocable decisions. Blumlein was mainly responsible for establishing the waveform that has (with very minor adjustments) been used in Britain ever since, and was declared by L. H. Bedford to be one of the outstanding technical triumphs of television. Blumlein explained the reasons for each decision in his 1938 I.E.E. paper.\*

The bearing of this waveform on an effective system of vision a.g.c. in receivers was foreseen by Blumlein, who invented several circuits for it; but a good many years passed before vision a.g.c. came into general use.

The extension of the bandwidth to zero caused troubles with power supplies, and Blumlein devised modifications to filter circuits to give them a constant resistive impedance at all frequencies. To cope with the high frequencies in amplifiers he originated the familiar series (Fig. 7) and shunt "building out" circuits. Among his many other television circuit devices were: "black spotting" to make interference less conspicuous; a method of sync pulse separation; "spot wobble"; an anti-"ghost" device; and (with E. C. L. White) the now familiar "efficiency diode."

As if this were not enough for one engineer, he was collaborating with J. D. McGee in devising the

\* "The Marconi-E.M.I. Television System; Part I: The Transmitted Waveform", *Proc.I.E.E.*, March 1939, pp. 65-73.

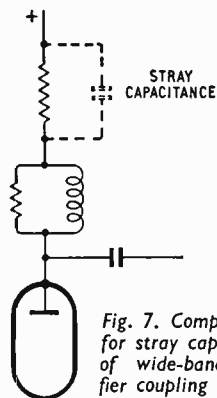
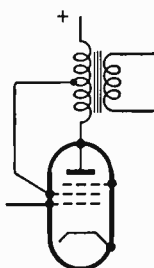

Fig. 7. Compensation for stray capacitance of wide-band-amplifier coupling resistor.

Below: Fig. 8. Essentials of "ultra-linear" or screen-feedback circuit.



very important C.P.S. Emitron, and with E. C. Cork in the r.f. cables that were used to convey the television signals between Alexandra Palace and Broadcasting House and elsewhere, and with H. E. Holman in the manufacture of very fine insulated wire. The only camera tube available for the opening of the B.B.C. television service in 1936 was the ordinary Emitron, in which relatively large spurious signals were created by secondary emission. Blumlein took a full share in providing "tilt" and "bend" signals to counteract them, and meanwhile was at work on the problem of a tube that would make this unnecessary. The McGee-Blumlein patent, No. 446,661, dated as early as 1934, describes an essential feature of the cameras introduced since the war and those now in general use throughout the world. This is cathode potential stabilization, by which secondary emission is prevented. A major improvement in the received picture was the result.

Several important inventions not particularly connected with television were contemporary with these. There was the "long-tailed pair," intended to rid push-pull signals of unwanted push-push components. Another, of great interest to *Wireless World* readers, was the so-called ultra-linear amplifier circuit, in which the screen grids of the push-pull output stage are tapped on to the output transformer. Here, again, it was a good many years before general practice caught up with Blumlein. Admittedly, he does not appear to have appreciated how effective this arrangement can be for reducing distortion; he regarded it mainly as a convenient alternative to the control-grid feedback shown in Fig. 4, for reducing the undesirably high impedance of pentodes while retaining their efficiency. One notes, by the way, how many of Blumlein's devices were concerned with impedance matching.

His freedom from convention can be illustrated by his contribution to the discussion of a paper entitled "Instruments Incorporating Thermionic Valves."\* It is worth quoting:

"All the devices referred to in the paper have one point of similarity—the signals are applied at the grid and come out at the anode. It might be worth while considering where it might be advantageous to depart from this convention. One possible application of valve voltmeters is to the measurement of very high voltages. For this purpose one constructs a valve where the grid is earthed and used as a shield between anode and cathode. A

very high voltage is put on a very small anode remotely situated from the grid, and in the cathode lead is put the inevitable feedback resistance, which is given a high value.\* In those circumstances the valve cathode rises to such a potential that there is practically no anode current. The valve acts as a potentiometer, the cathode voltage being about  $1/(\mu + 1)$  of the anode voltage. At first sight the arrangement would seem to have no advantage over a resistance-type voltmeter, but the usual very high-voltage voltmeter resistances are cumbersome, and this arrangement will follow variations of the anode voltage quickly, so that measurements of very high voltage can be made in the comparative safety of a shielded cathode."

This contribution was ignored by the authors in their reply!

Slot aeriels are now commonplace, having come into use during the war for short-wave radar. But in 1938, when Blumlein applied for the slot-aerial patent, which in due course was numbered 515,684, it must have seemed quite revolutionary.

Another Blumlein characteristic—dislike of dependence on uncertain parameters—is exemplified by his patent No. 563,464 of 1940, which describes a simple method of stabilizing the amplitude of oscillators without relying on grid current. The mode of operation is not nearly so simple as the relevant part of the circuit, shown in Fig. 9. Valves with extra diodes being still current practice, this idea might well be about due to be discovered!

By this time Blumlein, as senior engineer in the E.M.I. research laboratories, was at work on war projects. The adaptation of his stereo ideas to the aircraft sound locator has already been mentioned. The direction of the sound source relative to the axis of the locator was indicated by a trace on a c.r. tube. His early invention of the inductively-coupled ratio-arm bridge also found novel application in an altimeter depending on the change of capacitance, induced by the ground, between two electrodes fixed to the underneath of the aircraft. This type obviously was most advantageous at low altitudes, where others fail. It was fitted to Welling-

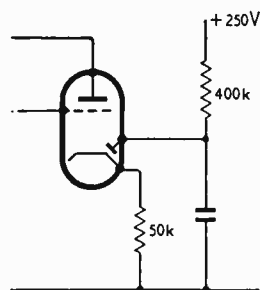

Fig. 9. Automatic amplitude control of oscillator by diode circuit. The oscillator circuit itself may be conventional.

tons and other aircraft for increasing the accuracy of torpedo laying at night. The same principles were employed in a general-purpose resistance and capacitance bridge developed for the Air Ministry. A particular merit of this type for airborne radar equipment was that measurements could be made without disconnecting the components from the circuit, which in some cases would have been impossible without damage, so tightly were they packed. The same is true of some present-day domestic sets!

\* *Proc.I.E.E.*, Sept. 1939, pp. 381-410.

\* British Patent No. 507,665, A. D. Blumlein and G. S. Bull.

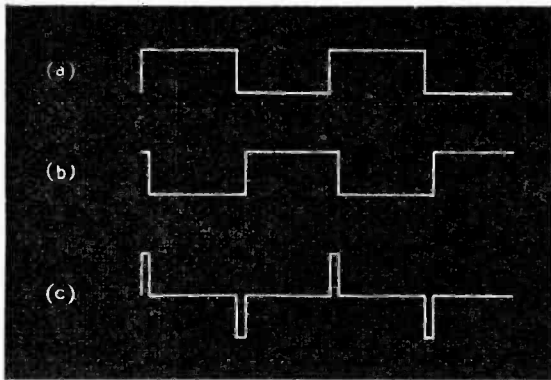

Fig. 10. Simple example of generating short pulses from longer ones by means of a reflective delay line.

One of the problems of radar is the generation of pulses of short duration, often only fractions of a microsecond, at precisely controlled instants. Such pulses are used in many low-power circuits, and also for modulating powers of hundreds of kilowatts in transmitters. In this field Blumlein made much use of the novel device of a short delay line. If a timing square wave such as Fig. 10(a) is applied to one end of such a line, and the far end is short-circuited, the step is reflected in opposite polarity. It reaches the input a short time later (b) and the resultant of the two is a pulse waveform (c). This principle was applied in many different ways for many purposes. In one particularly ingenious arrangement Blumlein used two lines end-to-end which were charged in parallel from the middle and discharged in series by a spark gap at one end, developing a high-power pulse for modulating airborne radar transmitters (Fig. 11). Delay lines are now well established as circuit elements.

One class of these airborne radars was AI, used to intercept enemy aircraft at night. The early types required an operator, which was very inconvenient in a high-performance fighter. In conjunction with E. L. C. White, Blumlein developed for production the locking strobe for AI Mark VI, which automatically performed the necessary operations of searching for an echo, locking on to it when found, and identifying it.

In these sophisticated types of radar there was need for a much more linear time base than those already available, and also for precise and adjustable time delays. To achieve these, Blumlein devised the basic circuit shown in Fig. 12, commonly known as the Miller integrator. His patent, No. 580,527, explains its principles and goes on to give a sample of each of the two applications just mentioned. These initiated a whole series of circuits,

using diodes as auxiliaries, including the celebrated "phantastron" and "sanatron." He also extended the principle to the integration of more than one voltage at a time, as used later in analogue computers.

During the war such patents were not published, and it turned out that the basic circuit was covered by a patent applied for by A. C. Cossor Ltd. and J. W. Whiteley a few months earlier. Actually Blumlein's invention was the earlier, but owing to the elaborate secrecy procedure some time elapsed before the application could be filed.

Two days after the application for Blumlein's patent was lodged, on 7th June 1942, he and two of his E.M.I. colleagues, C. O. Browne and F. Blythen, took off from Defford in a Halifax bomber to make tests on another airborne project—H.S. On the return there was engine trouble and the pilot attempted to land in a field, but on doing so the aircraft caught fire. There were no survivors.

For sheer quantity, Blumlein's inventiveness is impressive. No fewer than 132 patents were granted to him, with or without collaborators; that is to say, an average of one every 46 days during his entire

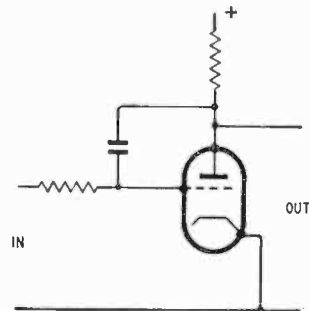

Fig. 12. Basic Blumlein integrator circuit, often wrongly attributed to Miller.

working life of 17 years! Nor is the total made up mainly of minor details or improvements, struggling for a little elbow-room of novelty among rivals.

A surprising number were so original as to carve out large new tracts and have very many claims admitted. Some were so original that years and even decades passed before their full value was appreciated. There may be some even now waiting for application.

Their most notable characteristic is that each is a practical solution arrived at by a careful study and clear understanding of the principles involved, rather than by chance or merely following the direction of current practice. How Blumlein would have enjoyed exploiting the possibilities of transistors! Is it unfair to those who have brought about such rapid developments in this field to suggest that he may have made a contribution through his influence? There can be no doubt that he set a fine example.

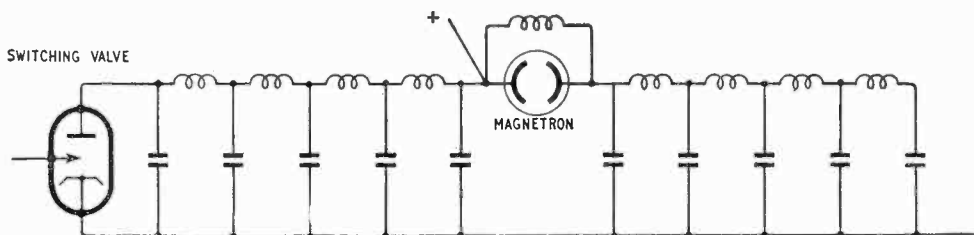

Fig. 11. Blumlein pulse modulator circuit.

# Quarter-wave Transformers

SOME NEW APPLICATIONS

By "CATHODE RAY"

**M**Y problem right at the start is to know whether it is necessary to explain what quarter-wave transformers are. After an interval for intense thought I have come to the not very helpful conclusion that for some readers it won't be and for others it will be. If my treatise on that subject had been published within the past few months I would have asked your permission to take it as read. But since it actually dates back 10 years, to the Aug. 1950 issue, I would be a little unreasonable to expect a favourable reply from young readers. So I'm going to cater for both classes by referring those whose hopes were aroused by the main title to the appendix,

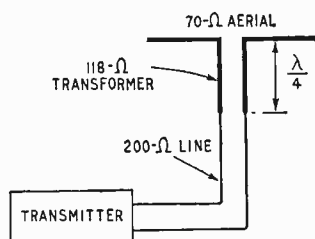

Fig. 1. Use of a quarter-wavelength line as a transformer (strikingly unlike the usual types) to match two unequal impedances.

while inviting those who were more interested in the sub-title to carry straight on.

For the reasons explained in the appendix, a piece of transmission line quarter of a wavelength long can be and often is used as a transformer to match a source of r.f. power to a load which has the wrong impedance for direct connection. Suppose for example the source was a 200-ohm line from a transmitter and the load was an aerial with an impedance of 70 ohms. If they were joined straight together there would be a mismatch at the junction, as a result of which a substantial part of the power arriving wouldn't go into the aerial but would be reflected back along the line, setting up standing waves and consequent excessive voltages and currents at certain points. The solution is to join the line to the aerial through a quarter-wave line transformer designed to have a characteristic impedance of  $\sqrt{70 \times 200} = 118 \Omega$ , as in Fig. 1. If the system was balanced to earth, one would make the transformer of parallel wires (or cylinders, for low impedances); if one side was earthed, a coaxial line.

That is old stuff. The April issue of our learned contemporary, *Electronic Technology*, had a contribution from a B.B.C. research engineer, Dr. G. J. Phillips, explaining quite a lot of other ways in which quarter-wave lines come in useful. They are all based ingeniously on the same principle—the way in which current and voltage change places, as it were, at opposite ends of the line. As you may have noticed, the principle of duality appeals to me, and here is an interesting example. For the benefit of those who are staring blankly, I will mention that duality is the term used to refer to the fact that for the relationships which hold for any circuit there are

analogous relationships for the "dual" of that circuit, derived from it by changing series into parallel, current into voltage, impedance into admittance, inductance into capacitance, etc., and vice versa.

We have just used the formula  $Z_i = Z_0^2/Z_L$ , in which  $Z_L$  is the load impedance,  $Z_0$  the quarter-wave line impedance, and  $Z_i$  the input resistance of that line with the load at the end of it.  $1/Z_L$  is the same thing as  $Y_L$ , the admittance of the load; so we have an impedance transformed into an admittance,  $Z_0^2$  being the connecting ratio. If  $Z_L$  happened to be an inductive load,  $j\omega L$ , it would be transformed to  $1/j\omega L$ , which (because  $j^2 = -1$ ) is  $-j/\omega L$ , the  $-j$  showing that the load has been transformed into a capacitance. The appendix shows that  $V_i = Z_0 I_L$ , etc., the ratio between voltages and currents being  $Z_0$ . And so on for other relationships.

Now consider a little problem. You have three or more items in a circuit, all of which have one terminal earthed, and you want to connect them all in series. Can you do it? Without, of course, shorting any of them! You are allowed to assume that the system works at only one frequency, in the v.h.f. region.

If I had begun with this it might have caught quite a few people out, but since the clue has been provided almost as obviously as in a give-away quiz, everyone should get the prize. The answer is to connect them in parallel through quarter-wave lines, as in Fig. 2, and these lines will transform the parallel connection to a series one.

Unless your intelligence is of a brilliance that would be wasted reading this, or your readiness to take my word for things is touching but unwise you will want

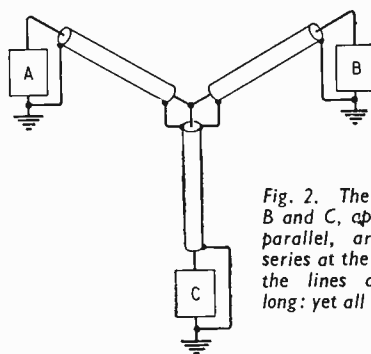

Fig. 2. The three impedances, A, B and C, apparently connected in parallel, are effectively all in series at the frequency that makes the lines a quarter-wavelength long: yet all are earthed.

a little more evidence before accepting that A, B and C are really all effectively in series. Looking at the circuit, and supposing that B and C have widely different impedances, one could be excused for not instantly seeing that a current generated in A must pass equally through B and C.

You will however grant that in a series circuit all items carry the same current, whereas in a parallel circuit all items receive the same voltage. And in a

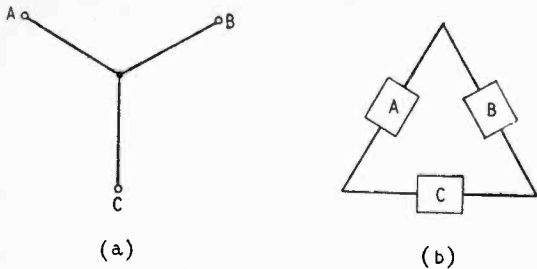

Fig. 3. Simplified version of Fig. 2, and its equivalent circuit.

series circuit the total voltage round it comes to zero (otherwise the same point would be at two different potentials at the same time), whereas in a parallel circuit the total current flowing away from the common junction is zero (otherwise some current would have to come from nowhere).

Now it cannot be denied that all the inner ends of the line in Fig. 2 are at the same voltage, seeing that they are all firmly connected in parallel. And in the appendix we have proved—I hope to everyone's satisfaction—that the currents entering the other ends are all proportional to that voltage, and are therefore equal provided that  $Z_0$  is the same for all the lines. So the same current must pass through A, B and C, and they are as good as in series. Moreover, the currents leaving the centre junction add up to zero, so the voltages across the outer ends of the lines add up to zero; again, just as they should do if they were all in series.

Of course, this state of affairs holds good only for the frequency that makes the lines quarter of a wavelength long—or a quarter plus any number of whole wavelengths. In practice one would avoid the latter alternative, because it would introduce unnecessary losses and undermine our assumption that these are negligible.

In Fig. 3 we have Dr. Phillips' suggested simplified

representation of Fig. 2, together with the equivalent circuit. Fig. 4(a) and (b) are exactly the same diagrams laid out slightly differently so as to make it clearer that A can be regarded as being in parallel with the combination B and C in series. Connections made directly at B and C instead of through inverting quarter-wave lines of course have their normal effect, so if another "star" is connected in parallel with them as at (c) they are also in parallel in the equivalent, (d). So it is possible to apply the same earthing technique to a series-parallel circuit.

Actually it can be done more simply. The quarter-wave lines attached to impedances A and B, looked at from the junction ends, are equivalent to impedances  $Z_0^2/A$  and  $Z_0^2/B$  respectively, as at (c), where  $Z_0$  is as usual the impedance of the line. So now we have the lines arranged in a closed ring instead of in star formation. Because Fig. 4(e) now has exactly the same formation when turned on its side, for all we know it might have been derived from an arrangement in which B and C were the impedances on stalks, in which case (f) would be its equivalent—and therefore the equivalent of (d).

Another point is that if Fig. 4(d) were a desired equivalent, in which A was say a capacitance, and operation was required over a band of frequencies, an actual circuit of form (e) would need an inductance  $Z_0^2/A$ , or alternatively A and a line as in (c).

If the quarter-wave line is doubled in length to make a half-wave line, the two quarter-wave impedance transformations cancel out. Doubting Thomases can satisfy themselves by going through the motions, thus: if Z is the impedance at one end of the half-wave line, then half-way along the line it will (owing to quarter-wave transformer action) look like  $Z_0^2/Z$ . This in turn, viewed through the remaining half of the line, looks like  $Z_0^2/(Z_0^2/Z) = Z$ . This is because the phase difference between a wave entering the line at one end, and the reflection of that wave arriving back, is one cycle; which is to say, in phase. And the phase difference between the

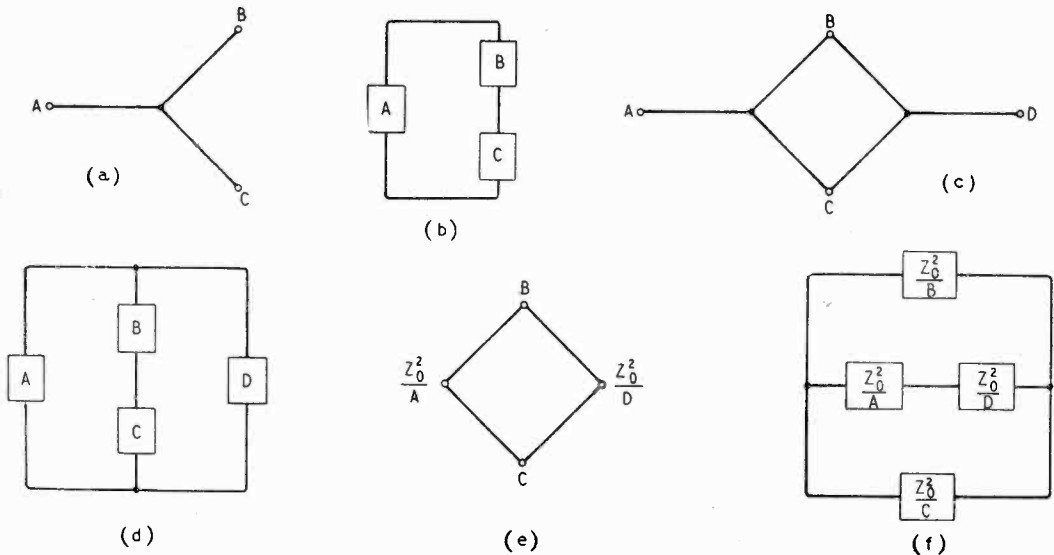

Fig. 4. (a) and (b) are identical with Fig. 3. (c) comprises two such star formations connected directly in parallel (without  $\lambda/4$  lines), and (d) is its equivalent. A and D in (c), with their  $\lambda/4$  lines, can be replaced by  $Z_0^2/A$  and  $Z_0^2/D$  directly connected, as at (e). This is therefore equivalent to (d), and so is (f).



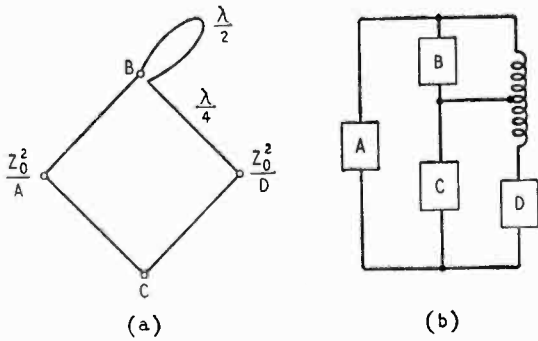

Fig. 5. A half-wave line is a 1 : 1 phase-inverting transformer, so by inserting it in one arm of Fig. 4(e) one gets the equivalent shown here at (b). This has some interesting properties.

two ends, being half a cycle, is in effect a reversal of polarity. So a half-wave line is commonly used as a reversing or 1 : -1 ratio transformer.

A useful circuit explained by Dr. Phillips is obtained from the preceding one by inserting a half-wave line in series with one of the four sides of the ring as in Fig. 5(a). (In practice a rather neater form of transformer can be used, but the principle is the same). Remember that in Fig. 4(d)—the equivalent of Fig. 4(e)—A and D are fed in phase by any voltage generated in B. The only change made in Fig. 5(a) is the introduction of a phase reversal in one of these arms, so in the equivalent circuit any B voltage feeds D in opposite phase to A. This is indicated by the 1 : -1 transformer in Fig. 5(b). The merit of this scheme is that if the impedances A and D are made equal the currents through them due to voltages in B will be equal and opposite, so they will cancel out in C. And voltages generated in C will send equal currents through A and D and the two halves of the transformer in such a way as to cancel therein and allow no appreciable voltage to be developed across B. So B and C communicate with A and D without affecting one another. Similarly, if B and C are equal, any voltages originating in A or D will affect them but not one another. This is the v.h.f. analogue of the "hybrid coil" used in telephony (and the "rat-race" used in waveguide circuitry).

The foregoing is only the beginning of what (to use an apt phrase) can be done along these lines. Anyone interested can obtain much more from Dr. Phillips' paper. But before closing down I had perhaps better do something for those who may have spotted an apparent contradiction. I have emphasized that these quarter-wave (and half-wave) lines work as described only at the frequencies corresponding to their lengths. On the other hand, except for standard-frequency transmissions all practical radio systems require a band of frequencies. At the sort of frequencies that make quarter-wave lines reasonable in length for circuit purposes, one expects to have television, f.m. broadcasting, and such things that take up quite a wide frequency band. However, it is usually only a small percentage of the nominal or carrier frequency, causing practically the same percentage departure from exact quarter wavelength, which should be tolerable in most applications. The effect of a quarter-wave line not being exactly quarter of a wavelength long for some part of the signal is

equivalent to introducing a reactance at the end of the line, and also to altering its characteristic impedance slightly. Here again, Dr. Phillips goes into the matter more deeply. He also shows how the whole idea can be applied to waveguides.

To end, here is a little problem arising from Fig. 4. Circuit (e) is entirely symmetrical in form; there is nothing to distinguish one pair of impedances from the other. ( $Z_0^2/A$  and  $Z_0^2/D$  could of course be denoted by single letters, such as E and F). It has two equivalents (d) and (f), in each of which one pair of impedances is distinguished from the other by being connected in series across them. One would expect—I would, anyway—that an entirely symmetrical equivalent existed. So far I haven't found a general equivalent; for the special case of  $B + C = Z_0^2/A + Z_0^2/D$ , there is a symmetrical equivalent consisting of all four connected in series. Can anyone produce an all-lumped circuit equivalent to (e) in which the impedances can have any values?

## APPENDIX

There is a limit to how far back towards the beginning of the story we can go just now, and anyone who doesn't know (and isn't prepared to take my word for it) that an endless transmission line is equivalent to a resistive impedance  $Z_0$ , called the characteristic impedance and determined by the cross-sectional geometry and materials of the line, will have to look it up in a book.

Fig. 6 shows a short length of line—parallel-wire

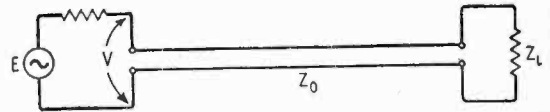

Fig. 6. A length of transmission line of characteristic impedance  $Z_0$ , fed at one end by a v.h.f. generator of source impedance  $Z_G$  and terminated at the other by a load impedance  $Z_L$ .

or coaxial—with a generator to supply an alternating e.m.f. E at one end, and a load impedance  $Z_L$  at the other. When the generator is first connected, a current I starts to flow. By Ohm's law\* I is equal to  $V/Z_0$ , V being the voltage at the generator terminals. Because time is needed for the wave of current to travel along the line,  $Z_L$  can have no effect at this stage. But when eventually (after a small fraction of a microsecond) the current reaches the far end, what then? If  $Z_L$  is equal to  $Z_0$ , Ohm's law continues to be satisfied and  $Z_L$  absorbs all the power that comes.

But suppose  $Z_L$  is greater than  $Z_0$ . Then, since the ratio of V to I arriving is right for  $Z_0$  it can't be right for  $Z_L$ . V is not enough to pass I through it. The falling off in current makes V rise, and because it is now greater than the line voltage it acts as a generator, driving the surplus current back along the line. In other words, part of the wave is reflected. The combined effect of voltage rise and partial return of current makes Ohm's law fit  $Z_L$ . Of course, no other laws must be broken in the process. The amount of power absorbed by the load, plus that sent back to the generator, must exactly equal what arrives. And the ratio of the surplus voltage and current, which we shall call  $v$  and  $-i$  (minus, be-

\* Meaning what is commonly but wrongly understood by this term: the relationship " $V = IR$ ," or " $V = IZ$ ." Actually Ohm's law was " $V/I$  is a constant."

cause it is a deduction from I), must of course equal  $Z_0$ .

Next, suppose that the length of the line is such that the time taken to travel once along it is equal to quarter of a cycle at the generator frequency. Then at any moment, if the pattern of current and voltage along it were visible, we would see quarter of one wave. We say it is a quarter-wave line.

That being so, there is half a cycle phase difference between the starting of a wave from the generator and the receiving back of the weaker reflected wave from the load. So if, as in our example, the reflected voltage at the load adds to the forward voltage, and the reflected current subtracts from the forward current, these phase relationships will be reversed at the generator. The total voltage at the generator terminals ( $V-v$ ) is less, and the total current ( $I+i$ ) is greater, than they were when the line fed a matched load.

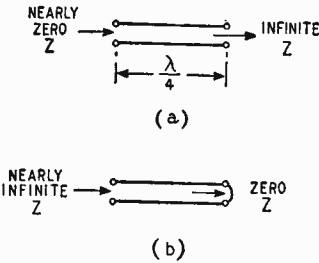

Fig. 7. The two extreme cases of quarter-wave transformation, in which an open circuit is made to look like a short circuit, and vice versa.

Their ratio  $(V-v)/(I+i)$  is therefore a smaller number than  $Z_0$ , and the quarter-wave line with its greater-than- $Z_0$  load presents a smaller-than- $Z_0$  impedance at the generator terminals. To take things to extremes, if the load end of the line were open-circuited, no power could be absorbed there, all the power would be reflected, the voltage at the generator terminals would be cancelled and the current doubled, so the input impedance of the line would be zero. This is the inverse of the infinite impedance of the load.

The same kind of argument for  $Z_L$  less than  $Z_0$  leads to the conclusion that at the generator end of the line it looks like a correspondingly higher impedance than  $Z_0$ . In the limit, the quarter-wave line transforms a short-circuit (zero  $Z_L$ ) into an apparent infinite impedance or open-circuit (Fig. 7). In fact, it is sometimes used as an insulator at the one particular frequency that makes it quarter of a wavelength long; at other frequencies its impedance is quite low, and at zero frequency negligible.

All we need now is to be more explicit. To comply with Ohm's law:

$$V = \frac{EZ_0}{Z_0 + Z_G} \quad \dots \quad (1)$$

$$\frac{V}{I} = Z_0 \quad \dots \quad (2)$$

$$\frac{v}{i} = Z_0 \quad \dots \quad (3)$$

$$\frac{V+v}{I+i} = Z_L \quad \dots \quad (4)$$

The resistance and other losses of the line itself are neglected. Let  $Z_1$  denote the input impedance of the quarter-wave line terminated by  $Z_L$ .

Then

$$Z_1 = \frac{V-v}{I+i} \quad \dots \quad (5)$$

Using (2) and (3) to substitute  $IZ_0$  for  $V$  and  $iZ_0$  for  $v$  in (4),

$$I+i = \frac{Z_L}{Z_0}(I-i) \quad \dots \quad (6)$$

Similarly  $V-v = \frac{Z_0}{Z_L}(V+v)$

So

$$\begin{aligned} Z_1 &= \frac{\frac{Z_0}{Z_L}(V+v)}{\frac{Z_L}{Z_0}(I-i)} \\ &= \left(\frac{Z_0}{Z_L}\right)^2 \frac{V+v}{I-i} \\ &= \frac{Z_0^2}{Z_L} \quad \dots \quad (7) \end{aligned}$$

$$\text{or } Z_0 = \sqrt{Z_1 Z_L}$$

So if you want to make any impedance  $Z_L$  look like a different impedance  $Z_1$ , interpose a quarter-wave line ("transformer") having a characteristic impedance equal to  $\sqrt{Z_1 Z_L}$ .

And if the input current and voltage,  $I+i$  and  $V-v$ , are called  $I_1$  and  $V_1$ ; and the output current and voltage,  $I-i$  and  $V+v$ , are called  $I_L$  and  $V_L$ :

By "Ohm's law"  $V_1 = Z_1 I_1$

Using (6)  $= \frac{Z_1 Z_L}{Z_0} I_L$

Using (7)  $= Z_0 I_L \quad \dots \quad (8)$

Similarly  $V_L = Z_0 I_L \quad \dots \quad (9)$

That is to say, for a given type of quarter-wave line, the voltage at either end is proportional to the current at the other end.

## I.E.E. PREMIUMS

THE premier award of the Electronics and Communications Section of the I.E.E.—the Duddell Premium (£20)—for papers read or accepted for publication during 1959, is to be given to Dr. G. B. B. Chaplin (Plessey), A. R. Owens (University College of N. Wales) and A. J. Cole (Plessey) for their papers "A method of designing avalanche transistor trigger circuits" and "A sensitive transistor oscillograph with d.c. to 300 Mc/s response." The Ambrose Fleming Premium (£15) goes to Dr. A. E. Karbowiak and V. H. Knight, of Standard Telecommunication Laboratories, for "An experimental investigation of waveguides for long-distance transmission."

Premiums of £10 each are being awarded to A. H. W. Beck (for his paper "High-current-density thermionic emitters: a survey"), L. Lewin ("The efficiency of a ferrite as a microwave mixer," "A ferrite boundary-value problem in a rectangular waveguide" and "Phase measurements through tapered junctions"), and G. Craven and V. H. Knight ("The design and testing of integrally constructed waveguide assemblies"), all of Standard Telecommunication Laboratories, Professor A. L. Cullen ("Theory of the travelling-wave parametric amplifier") of Sheffield University, R. Beaufoy ("Transistor switching-circuit") of British Telecommunications Research, and to H. A. C. Hogg ("Periodic electro-static beam focusing") of G.E.C. Research Laboratories.

The premier award of the Measurement and Control Section (the Silvanus Thompson premium—£20), goes to Dr. L. Essen, E. G. Hope, J. V. L. Parry and J. McA. Steele for two papers on the N.P.L. caesium standard.

# Transistor Inverters and Converters

## 2.—Basic Principles of the Push-pull Square-wave Oscillator System

By M. D. BERLOCK,\* *Grad. I.E.E.*, and H. JEFFERSON,\* *M.A.*

**I**N the first article we described the single-ended transistor oscillator which operated on what might be described as a pump basis. The energy is fed into a storage device, which is actually an inductor, on the charging stroke and then transferred to the load on a second, discharge, stroke. The limitations of a system of this kind are fairly easily seen. At best each part of the circuit is working for half the time so that the losses involved in cramming

energy stored in the system. An oscillator of this kind will also, of course, have a stored energy content large compared with the energy delivered to the load. Not surprisingly, this means that at low frequencies the tank circuit is both bulky and noisy.

The square-wave circuits with which we are concerned have, in their ideal form, no stored energy at all. The transistors act as switches, the transformer, for most of the time, purely as a transformer. Each half-cycle is an operation independent of the past. Let us examine the basic form of the circuit, which is shown in Fig. 1. It has, as you can see, the appearance of an oscillator circuit, although the tank circuit capacitance is missing and, as we shall see, the concept of inductance should not be applied to the collector winding of T. The core of T is, indeed, one of the so-called square-loop materials which have ideally infinite permeability below saturation and a very sharp knee at which the permeability falls to a very small value. How does this circuit operate?

When we first switch on let us assume that Q1 is in a higher gain condition than Q2. Current flowing into Q1 produces, through the conventional transformer action of T, a forward bias into the base of Q1 and a cut-off bias into the base of Q2. In consequence Q1 becomes a virtual short-circuit—a voltage drop of less than one volt at a current of ten amperes is normal. Across one half of the collector winding of T, we have almost the whole of the supply voltage and this, appropriately transformed, appears across the load.

The basic circuit during this phase of the operation can be simplified right down to that shown in Fig. 2, with the transistor put in even though it is a short-circuit, and the load resistance transformed back as a resistance R across the half collector winding. We could now write

$$\frac{dI_m}{dt} = \frac{V}{L}$$

But the trouble is that in a circuit of this kind the only way to define L is by the equation

$$L = \frac{V}{dI_m/dt}$$

We can avoid this difficulty by considering the

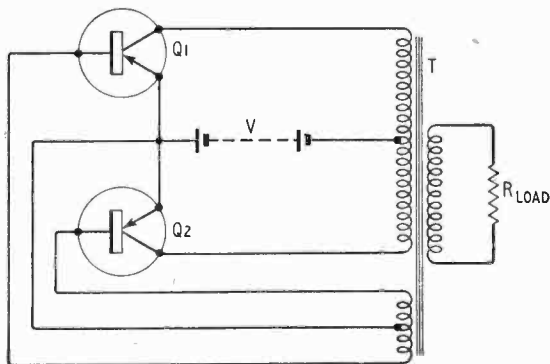

Fig. 1. Basic Uchrin-Royer circuit with a saturable collector transformer.

the energy through are doubled, while any deviation from the 50-50 ratio reveals that what you lose on the swings you do not get back on the roundabouts.

The use of a push-pull oscillator circuit operating in class-B is an obvious step forward in converting direct current to alternating. We can see, indeed, the whole family of class-B and class-C oscillators of traditional design but modified to use transistors available for this purpose. Much more interesting, however, is a family of push-pull square-wave oscillators which have come into use only with the advent of transistors. These oscillators are now quite widely used and provide efficiencies which range from perhaps 80% upwards depending on the conflict of the requirements presented to the designer: 95% is not uncommon but demands a bigger, more expensive unit than 90%. The choice is there to be made.

It is an interesting problem in semantics whether these circuits should be described as oscillators at all. The essence of an oscillatory system, one might say, is that it should have two energy storage methods with the energy being passed from one to the other and back again. In the pendulum the energy is now potential, now kinetic: in the LC oscillator the energy is now  $\frac{1}{2} CV^2$ , now  $\frac{1}{2} LI^2$ , in the tank circuit. The active element provides a make-up energy which is small compared with the

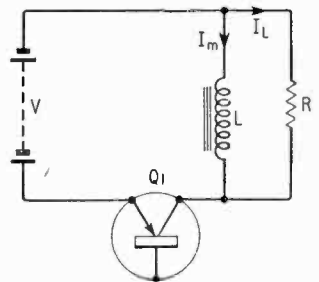

Fig. 2. Essential circuit for the switching operation of Fig. 1.

\*The Phoenix Telephone and Electric Works Ltd

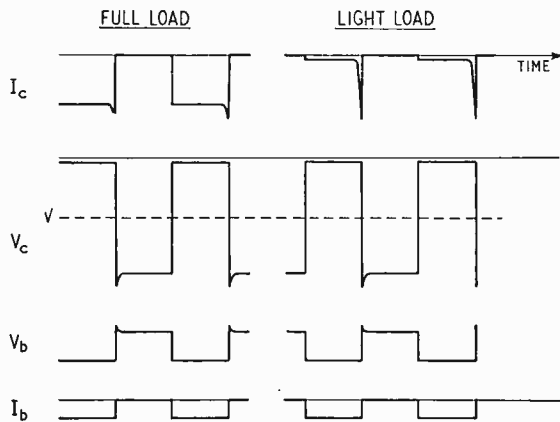

Fig. 3. Waveforms in Fig. 1 under full and light load conditions. Note the high current spike even under light load.

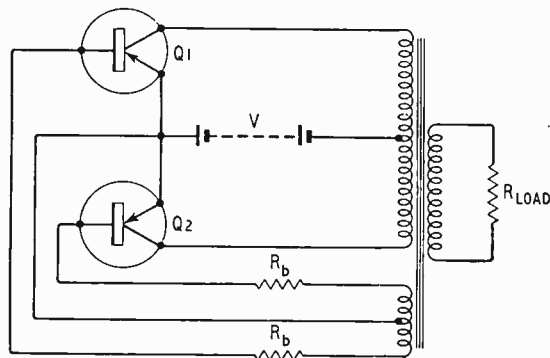

Fig. 4. Practical circuit with base current control.

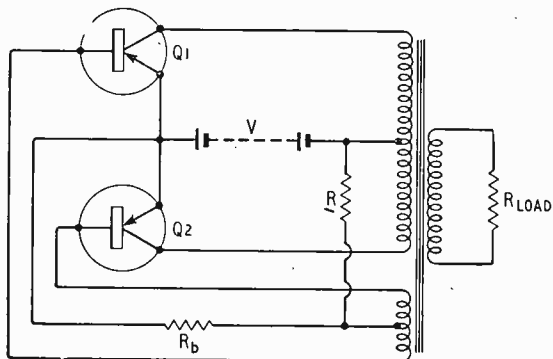

Fig. 5. Simple method of biasing the transistors.

flux,  $B$ , in the core, which satisfies the equation

$$\frac{dB}{dt} = \frac{V}{nA} \times 10^8$$

where  $n$  is the number of turns and  $A$  the core area. From this we see that we have

$$B = kV(t + t_0)$$

( $k$  and  $t_0$  are constants)

This flux is associated with a magnetomotive force  $H$  which can be written simply as

$$H = C I_m \quad (C \text{ is another constant})$$

We can make life easier by writing  $t_0 = 0$  so that

$$B = kVt$$

and we see that there is a steady growth, directly proportional to time, in the value of  $B$ . We know that  $B$  and  $H$  are connected by the equation  $B = \mu H$ , though  $\mu$  is very large and probably not very constant.

In consequence we have

$$I_m = \frac{kVt}{\mu C}$$

which is proportional to time and, because of the size of  $\mu$ , rather small. There comes a limit to this state of affairs, however, when  $B$  reaches some value  $B_c$ . Any further increase in  $B$  then requires a very large increase in  $H$ , or if you prefer it,  $\mu$  falls to a very small value. In consequence  $I_m$  attempts to rise rapidly to meet this demand.

The total available current is, however, limited by the transistor to a value  $\beta I_b$ , so that  $I_m$  can rise only if  $I_b$  falls. We have, however,  $V = RI_L$ , so the voltage across the winding collapses. The onset of this condition reduces the base drive to  $Q_1$  and the positive feedback loop drives  $Q_1$  off. The stored energy  $BH$  is small, but it is sufficient to lift  $Q_2$  into conduction and away we go, in the opposite direction.

The current and voltage waveforms for this circuit are shown in Fig. 3. It will be seen that the transistors are subjected to twice the supply voltage when cut-off and that the current is almost constant during the on period. In practice it is found that the voltage spikes shown, which are due to leakage reactances, may be substantial. The whole transient switch-over period is a rather dangerous one, with the very high current spike just at the end of the conduction period giving high dissipation in the transistor and also presenting a momentary heavy loading on the supply line. This current spike makes the transient behaviour very dependent on supply impedance.

The first stage in setting up a practical circuit of this kind is shown in Fig. 4. This circuit differs from the simplified circuit of Fig. 2 in the addition of the base current limiting resistors  $R_b$ . To begin the design we must, of course, choose our transistors. We assume that the supply voltage and power output are fixed: the current drawn from the supply will be something more than (power)/(voltage) and during its on period all this current flows through one transistor. Thus for a 30-W inverter operating from a 12-V supply the collector current rating must be over 2.5A. Because the efficiency will not be

Fig. 6. More economical method of biasing the transistors.

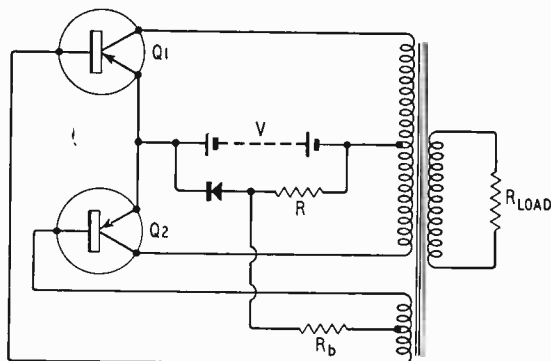

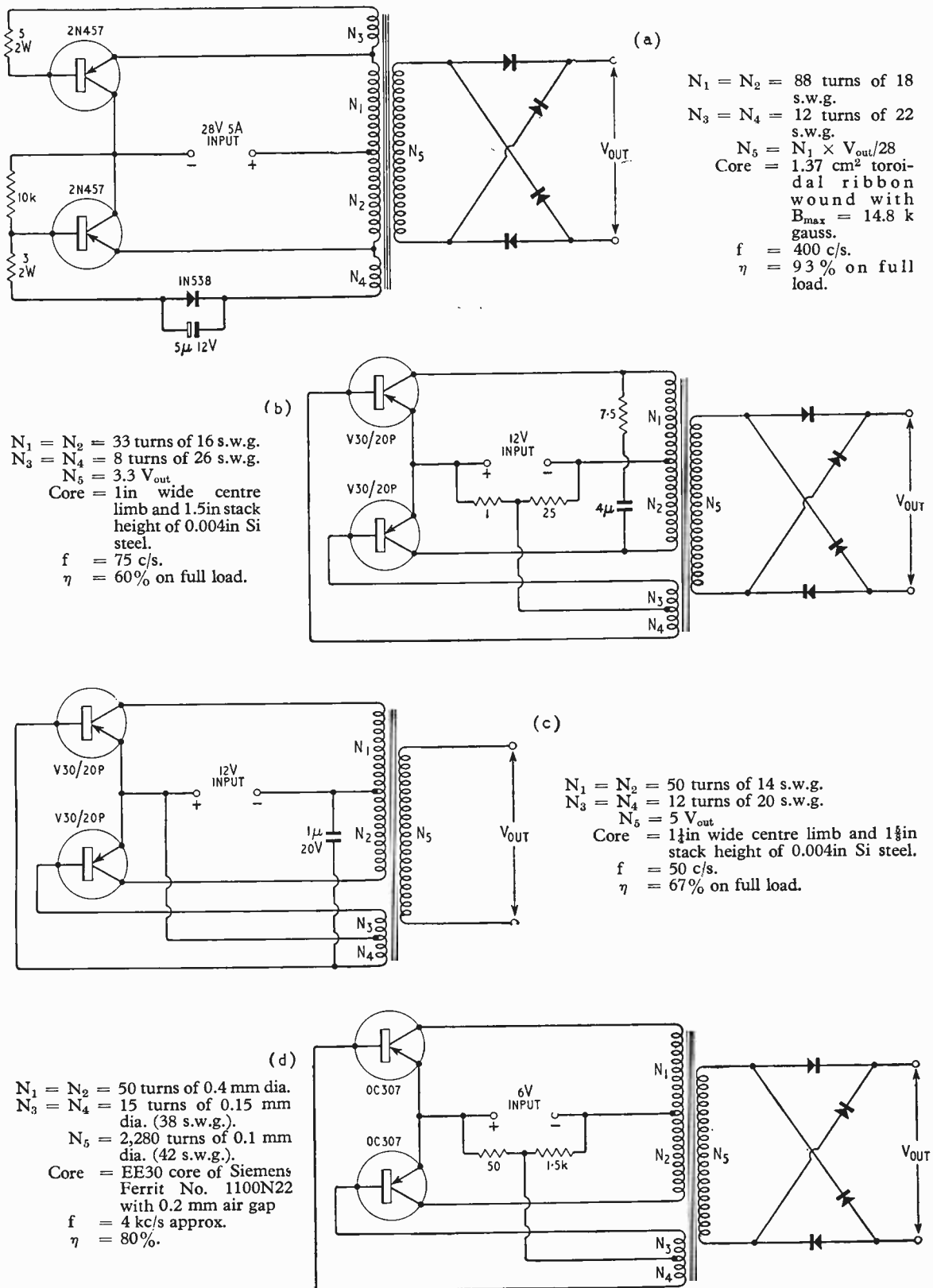

Fig. 7. Typical designs for inverters: (a) is suggested by Texas Instruments in their Bulletin No. DL-S 909, March 1958, (b) and (c) by Newmarket Transistors in their Application Notes Nos. 18 and 22 respectively, and (d) by Brush Crystal on p.21 of their Intermetall "Silizium-Germanium Halbleiter Bauelemente" (1959).

100% the current might be assumed initially as 3A. The voltage on the cut-off transistor will be twice the supply voltage, which for a charged battery means some 28-30 V.

These rather rough and ready sums are intended just to guide us in preparing a short list of possible transistors. For our example the average current is about 2.5A and the peak current will probably be about 4-5A during the spike. Prices and deliveries will now play some part in cutting down the list.

When a transistor has been selected we have the essential data for continuing the design: lack of this data is a reason why one manufacturer's products never appear in the short list. To drive the transistor fully on the data will indicate that we need some base current  $I_b$  which may be given in characteristic curves, or may be taken from the minimum value of  $\beta$  as simply

$$I_b = I_c / \beta$$

To get this current to flow into the base we need a base-emitter voltage  $V_{be}$  so that the ratio of the transformer must be

$$\frac{N_2}{N_1} = \frac{V_{be} + I_b R_b}{V_{cc} - V_{ce}}$$

where  $V_{cc}$  is the supply voltage and  $V_{ce}$  the transistor knee voltage. In what follows we shall write  $V_{ce}$  in place of the more exact form  $V_{cc} - V_{ce}$ . If  $R_b$  is such that  $V_{be} N_2 / R_b N_1$  is less than the maximum permitted value of  $I_b$  then the transistor cannot be overdriven.

The next problem is to decide the value of  $N_1$  the collector winding. This is given by

$$N_1 = \frac{V_{cc} \times 10^8}{4 A f B_c}$$

The manufacturers of square-loop core materials, such as HCR, Mu-metal and some ferrites, give details of the saturating flux density  $B_c$ . The choice of area  $A$  and frequency  $f$  is left to the designer. He will begin by choosing a frequency based on a previous design. It will not be high, because the transient loss will become too great: it will not be too low, or  $N_1$  becomes too large. A convenient value for the 10-100 W class of converter is 400-800 c/s. With the value of  $f$  determined a core size must be guessed, to give a value of  $A$  and thus of  $N_1$ . We now make the first test, to see whether we can actually wind two windings of  $N_1$  into half the window area of the core chosen (the other half is reserved for the load winding). Resistance, copper-loss and core-loss calculations follow with the usual painful reappraisal and the choice of a new core size. As this side of the design work is leading towards a satisfactory compromise between cost and efficiency, a new assessment of frequency may be made.

As the process of transformer design approaches completion it becomes necessary to examine the losses in the transistor itself. When passing its full current there will be a drop of about 0.5 to 0.8 V across the collector-emitter path and for a current of 3A this means a loss in the pair of 1.5-2.4 W. Transient distortion is more difficult to estimate even when the waveform can be displayed on an oscilloscope, and in general is small enough to be omitted from a broad study unless the frequency is abnormally high. The term we have just considered, say 2 W out of 30, suggests the order of magnitude we must allow for the transformer loss. The base circuit loss is added and we have a good idea of what

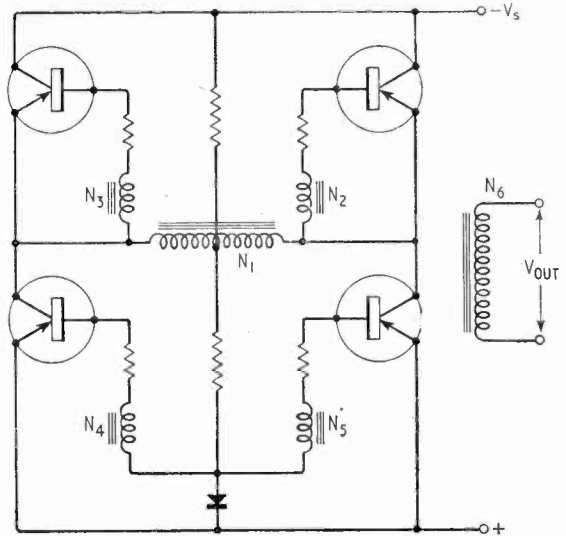

Fig. 8. For higher voltages two transistors are put in series in a design suggested by Mullard. ( $N_1, N_2, N_3, N_4, N_5$  and  $N_6$  are all on the same core.)

the inverter will do. For our arbitrary example with a 3A limit and an output of 30 W we cannot afford more than 6 W total loss. This means an efficiency of 83%, which is quite reasonable.

It is now necessary to elaborate the circuit slightly. The elementary circuit has the transistor bases returned directly to the emitters and the transistors may therefore be regarded as biased pretty close to cut-off. The loop gain will often, though not always, be too low to start the system oscillating and this is especially true when the load is permanently connected.

One starting mechanism used consists merely of a resistor in one base line, the base winding of the transformer being split to enable it to be put on the battery side of the winding, with a capacitor taken back to the negative centre-point of the collector winding. When the battery is suddenly applied this base is flicked sharply negative into a high-gain region and the circuit starts off. The disadvantage is that if the supply does not come on quickly enough the base does not get sufficient kick. When a large capacitor is connected across the supply terminals and the battery leads have significant impedance there may be starting trouble. Increased resistance means better starting but also, since base current flows through the resistor, lower efficiency.

Stephenson has shown in *Electronic Engineering*, Vol. 31, No. 380, October 1959, that to get this kind of oscillator to start it is necessary to provide a minimum base current of

$$25 n / (\beta R_L - n R_b) \text{ mA,}$$

where  $n$  is the (collector winding)/(base winding) turns ratio,  $R_L$  the collector load, and  $R_b$  the total resistance in the base path. For very simple applications it is sufficient to adopt the standard method of biasing the transistors to this working point. The result is the circuit shown in Fig. 5. Although this circuit is economical in components it is wasteful in power as the base current, which may be substantial, must flow through the bias resistors.

The standard bias circuit is that shown in Fig. 6.



The resistor provides the starting base current given by the expression above. It is, of course, quite calculable. The much larger base current taken once the system starts oscillating will flow through the diode. Once the diode is conducting the voltage drop across it does not vary very much with current and in a typical case of a 100-W inverter the diode current of 1 A results in a voltage drop of about 0.7 V a power loss of only 0.7 W. Allowance must be made for this additional voltage drop in determining the ratio  $N_2/N_1$ .

Starting circuits involve the designer in a compromise which must be studied rather carefully. As we have seen, the starting condition is that a specified minimum current should flow in the transistors: this current must not be large enough to overheat the transistors if the load on the inverter is excessive and the circuit fails to oscillate.

The basic Uchirin-Royer inverter which has been described in this article is probably at the moment the most commonly used form of circuit. Most transistor manufacturers publish designs for using their transistors in this way and give details of the transformers. Some, at least, of the inverters available commercially are based on their information.

Typical designs are those illustrated in Fig. 7.

For higher supply voltages it is possible to work with two transistors in series in the circuit shown in Fig. 8. This circuit was described in *Mullard Technical Communications*, Vol. 4, No. 36, December 1958. All the transformer windings are on a common core of HCR laminations.

There are a number of disadvantages to the simple transistor inverter which we have described here. In the next article we shall discuss these and show how they are overcome in another slightly more complex circuit. We also hope to describe a new variant of this circuit which is slightly more economical and which has been found to have a number of operating advantages.

**Corrections:** In part I of this article (August issue): on p. 400, col. 2, line 21, C, should read  $C_1$ ; on p. 401, col. 1, line 11 should read  $I_c = \beta I_b$ ; on p. 402, col. 1, line 10, "to" should be deleted; line 19 of the same column should read

$$I_{pk} = \frac{4W(t_1 + t_2)}{E t_1}$$

line 27 of the same column should read  $I_b = I_{pk}/\beta = E(N_2/N_1)/R_b$ ; on p. 402, col. 2, line 19 should read  $t_1 = L_1 I_{pk}/E$ .

## HOW PRECISE IS YOUR ATTENUATOR?

EFFECT OF RESISTANCE TOLERANCES ON ATTENUATOR ERRORS

By H. STERN, B.Sc.

**T**HE simple potential divider, consisting of two resistors in series (Fig. 1), is frequently used in electronic equipment to adjust the level of an incoming signal; for instance, it is used as the input attenuator in many cathode-ray oscilloscopes. In many cases the divider consists of high-stability close-tolerance resistors, the accuracy of the step-down being dependent on the accuracy of the resistors.

From comparison of circuit component values with the specifications of some instruments and from conversations with several engineers, it is obvious that it is frequently assumed that, if resistors of equal percentage tolerance are used in the divider, the maximum percentage error in the step-down ratio will be equal to that tolerance. It will be shown below that this is only true in a very limited number of cases.

If we let the desired voltage ratio  $V_{out}/V_{in}$  equal  $n$  we have, assuming precise resistor values:

$$n = \frac{R_2}{R_1 + R_2} \dots \dots \dots (1)$$

Taking partial differentials we get:

$$\frac{\partial n}{\partial R_2} = \frac{R_1}{(R_1 + R_2)^2} \text{ and } \frac{\partial n}{\partial R_1} = -\frac{R_2}{(R_1 + R_2)^2}$$

$$\text{Now } \delta n = \frac{\partial n}{\partial R_2} \cdot \delta R_2 + \frac{\partial n}{\partial R_1} \cdot \delta R_1$$

$$\therefore \delta n = \frac{R_1 \cdot \delta R_2 - R_2 \cdot \delta R_1}{(R_1 + R_2)^2}$$

$$\text{And hence } \frac{\delta n}{n} = \frac{1}{n} \cdot \frac{R_1 \cdot \delta R_2 - R_2 \cdot \delta R_1}{R_1 + R_2}$$

and by appropriate substitutions for  $R_1$  and  $R_2$  from equation (1) we get

$$\frac{\delta n}{n} = (1 - n) \left( \frac{\delta R_2}{R_2} - \frac{\delta R_1}{R_1} \right) \dots \dots \dots (2)$$

From (2) it is obvious that the maximum percentage error in the ratio  $n$  will be proportional to the sum of the percentage errors in the two resistors

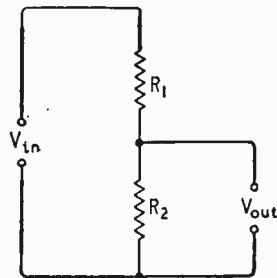

Fig. 1. Simple resistive potential divider.

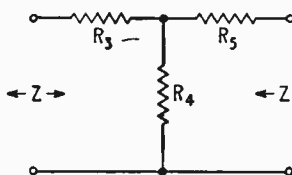

Fig. 2. T-type attenuator.

Fig. 3. Fig. 2 redrawn as two cascaded potential dividers.

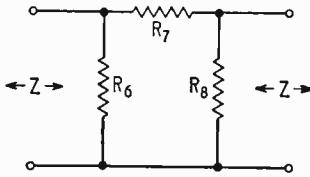
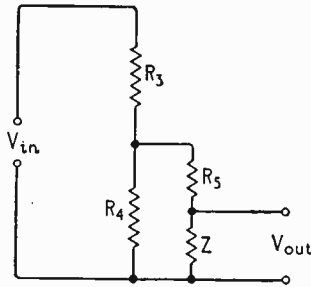

Fig. 4.  $\pi$ -type attenuator.

Fig. 5. Fig. 4 redrawn as a potential divider.

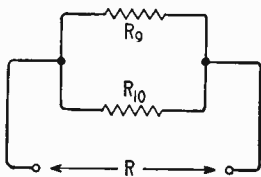
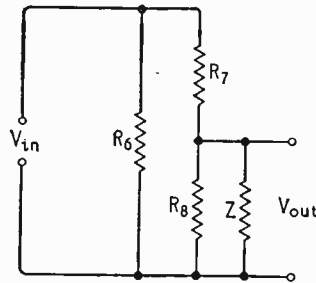
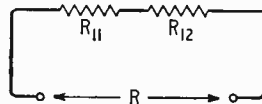

Fig. 6. Two resistors in parallel.

Fig. 7. Two resistors in series.



(i.e.  $\propto (\delta R_1/R_1) + (\delta R_2/R_2)$ ) and will increase for a given resistance tolerance as the attenuator ratio  $1:n$  ( $n < 1$ ) increases.

If resistors of equal percentage tolerance are used we get:

$$\frac{\delta n}{n} = 2(1-n) \frac{\delta R_2}{R_2}$$

$$\text{Thus } \frac{\delta n}{n} \leq \frac{\delta R_2}{R_2}$$

Only if  $(1-n) \leq \frac{1}{2}$

i.e. if  $n \geq \frac{1}{2}$

i.e. if  $R_2 \geq R_1$

In most cases the step-down ratio  $1:n$  is greater than 2 and in consequence the maximum percentage error in the ratio is greater than the tolerance of the resistors used. In the limit, as  $n$  approaches zero we have:

$$\frac{\delta n}{n} \text{ tends to } 2 \frac{\delta R_2}{R_2}$$

In a practical example, for a  $100:1$  ratio with  $\pm 1\%$  resistors the error in the attenuator ratio may be as great as  $1.98\%$ .

The above considerations may easily be extended to cover more complex attenuator circuits. For instance, a T type of attenuator (Fig. 2) may (assuming purely resistive loading) be redrawn in the form of two cascaded potential dividers (Fig. 3). The first of these dividers has the combination of  $R_4$  shunted by  $R_5$  in series with  $Z$  as its lower arm.

In a similar way a  $\pi$ -type attenuator (Fig. 4) can be redrawn as a potential divider (Fig. 5).

The maximum possible error can then be calculated from the above theory if one takes into consideration the following factors:

For a parallel combination of resistors (Fig. 6):

$$\frac{\delta R}{R} = \frac{1}{R_9 + R_{10}} \left( R_9 \frac{\delta R_{10}}{R_{10}} + R_{10} \frac{\delta R_9}{R_9} \right)$$

If  $\frac{\delta R_9}{R_9} = \frac{\delta R_{10}}{R_{10}}$  this simplifies to  $\frac{\delta R}{R} = \frac{\delta R_9}{R_9} = \frac{\delta R_{10}}{R_{10}}$

For resistors in series (Fig. 7):

$$\frac{\delta R}{R} = \frac{\delta R_{11} + \delta R_{12}}{R_{11} + R_{12}}$$

Again, if  $\frac{\delta R_{11}}{R_{11}} = \frac{\delta R_{12}}{R_{12}}$  this simplifies to

$$\frac{\delta R}{R} = \frac{\delta R_{11}}{R_{11}} = \frac{\delta R_{12}}{R_{12}}$$

## Commercial Literature

**Electronic Cable Gauge**, for continuous measurement of diameter in cable works, based on a scanning light beam and photoelectric pick-up, with a system for measuring the time interval of the cable shadow passing across the pick-up. Said to be more accurate than light intensity methods. Leaflet from The Addison Electric Company, Ltd., 10-12 Bosworth Road, London, W.10.

**Catalogue of Components** made by A. F. Bulgin and Co. Ltd., Bye Pass Road, Barking, Essex. 2s 6d by post, or free to trade.

"**Electronic Measurement**" is the title of a new edition of a 23-page catalogue of Marconi test instruments. From Marconi Instruments, Ltd., (home) Marconi House, Strand, London, W.C.2, (overseas) St. Albans, Herts. (U.S.A.) 111, Cedar Lane, Englewood, New Jersey.

**Television and V.H.F. Distribution** systems made by Belling and Lee Ltd. are constructed on a modular basis to ensure serviceability and adaptability. The equipment is suitable for any size of installation and any television receiver or v.h.f. radio can be connected. Booklet from Belling and Lee Ltd., Great Cambridge Road, Enfield, Middlesex.

**Sensitive D.C. Relay**, Type K01, made by B. & R. Relays, is an alternative to the well-known P.O. 3,000 pattern, but is not affected by 25g acceleration. Vibration-resisting qualities are enhanced by replacement of the usual knife-edge armature support by a stainless steel shaft. Details of this and many other relays are given in a new catalogue from B. & R. Relays Ltd., Temple Fields, Harlow, Essex.

"**Resins and Glues for Industry**" is the title of a new edition of the catalogue of Lester, Lovell & Co. Ltd., North Baddesley, Southampton.

**Five-valve 250-W a.f. amplifier** or **150-W 30Mc/s transmitter** are two possible applications of the S.T.C. Type 828 beam-power amplifier valve. Application report giving details from Standard Telephones and Cables Ltd., Special Valve Sales Department, Footscray, Sidcup, Kent.

**Valves and C.R.T.s** for industrial purposes, comprising several hundred items, are listed in the 1960 edition of G.E.C.'s catalogue. From M-O Valve Co. Ltd., Brook Green, Hammersmith, London, W.6.

**Automatic Stereo Phase Corrector** developed by the American Columbia Broadcasting System laboratories was described at the recent New York I.R.E. Convention. In this corrector, portions of both the left and right stereo signals are amplified and then added and subtracted, the sum and difference signals so formed being then rectified. The resulting d.c. signals are applied to a mechanical flip-flop. If the relative phases of the left and right stereo signals are correct, the sum d.c. signal will be greater than the difference. If this is not so, the mechanical flip-flop automatically reverses the phase of one stereo signal to correct their relative phases.

**Pinlite** sub-miniature incandescent electric light shown in the photograph is claimed by its manufacturer, the American Kay Electric Company, to be at least 30% smaller than the

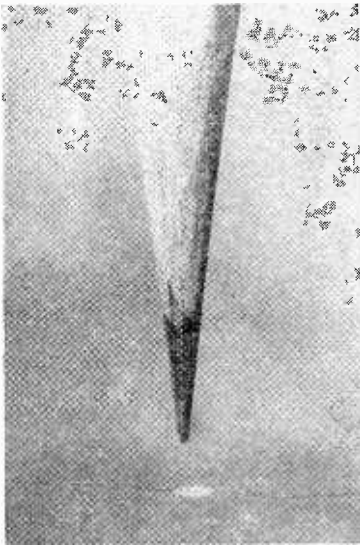

next smallest mass-produced bulb. Its actual dimensions are 0.062in long by 0.015in in diameter and it operates from a supply of 1.5V at 15mA. Possible uses for this bulb are in computer readouts or as a meter pointer position indicator. Because it operates at low voltages and currents it is also suitable as a transistor circuit on/off indicator.

**Cleaning Flux** from printed-wiring boards is necessary to avoid subsequent breakdown due to short circuiting or corrosion. In *Electronic Industries* for November 1959 (p. 110) results of a radioactive-tracer test are given. Flux containing a radio active substance was brushed on to the boards and allowed to dry. The boards then solder-dipped at 520°F for 5 seconds. Cleaning methods compared were mechanical agitation in a 100% chlorinated solvent and a water-based detergent solution, and

# Technical Notebook

sonic agitation in the same two liquids. The results were, in per cent flux removed: 82%, 91.3%, 89.1% and 97.8% respectively. In the last case, the 2.2% remaining flux was found to be trapped in the solder and board or dispersed so as not to be a hazard in the future life of the board.

**Gallium Arsenide Transistor** has been developed by R.C.A. according to the May 13 issue of *Electronics*. One advantage of using GaAs as the semiconductor in a transistor is that it can be operated at a higher temperature even than Silicon—250°C compared with 175°C. The new R.C.A. transistor is a diffused-junction drift-field type with an alpha cut-off frequency of approximately 100Mc/s.

**Pulse Sharpener**, described by J. F. Golding and L. G. White in the September 1959 issue of *Electronic and Radio Engineer* (now *Electronic Technology*), uses a pentode switched on by the differentiated pulse leading edge to rapidly discharge the stray capacitance across which the pulse is developed and thus to provide a very fast pulse leading edge.

**"Cocktail Party" Effect**—i.e. one's ability to concentrate at a cocktail party on a single voice amid the surrounding babble and other party noises—has been reproduced electronically by E. E. David and J. F. Kaiser at the Bell Telephone Laboratories. This effect is due to our being able to separate sound sources according to their different directions, and in a two-eared listener can produce an apparent improvement in the signal-to-noise ratio of from 5 to 15dB. Since this improvement is greater than that theoretically possible by means of linear processes, non-linear processes were used in attempting to reproduce this effect electronically. In one experiment the outputs from two spaced microphones were compared by cross

correlation to produce a gating signal. This signal was arranged to increase the combined output of the two microphones when they each produced simultaneous identical signal outputs. (It was also, of course, arranged that such simultaneous signals were produced by the voice to be concentrated on.) Interfering signals then only had their intensities increased if they occurred at the same time as the desired signal. In this way in the combined microphone output the signal-to-noise ratio was improved by 9dB with a single interfering talker and by 5dB with two interfering talkers.

**Artificial Reverberation** obtained from mechanical spring delay lines (see photograph) developed by the Hammond Organ Company is being incorporated in new American Philco and Zenith stereo record reproducers. Two lines giving delays of 29 and 37msec are used. According to *Electronic News* for the 30th May, the delay is obtained from torsional motion of the springs; conversion between this torsional motion and the electrical input and output signals being carried out by means of ferrite rotors. By deliberately mismatching the delay lines, repeated reflections are produced and the delayed signal decays logarithmically as in natural reverberation. In the Philco units the sum of the left and right channels is reverberated and fed back into the left and right channels. In the Zenith units, the stereo signals are summed and differenced, and the sum channel is reverberated and fed into the difference channel.

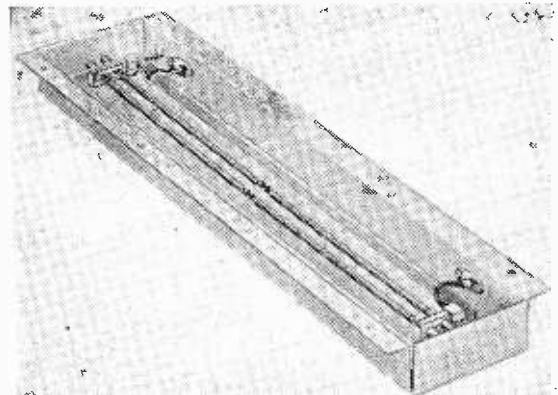

# Elements of Electronic Circuits

## 17.—BLOCKING-OSCILLATOR TRANSFORMER-COUPLED TIMEBASE

By J. M. PETERS, B.Sc. (Eng.), A.M.I.E.E., A.M.Brit.I.R.E.

**A**LTHOUGH this type of relaxation oscillator is used primarily as a square-wave generator, a sawtooth waveform can be obtained from it. Fig. 1 shows a simple form of free-running blocking oscillator and Fig. 2 illustrates the waveforms.

Superficially the circuit resembles the familiar tuned-grid oscillator without its tuning capacitance, but its action is rather more complex. A single triode amplifier is used and the necessary positive feedback is obtained from the antiphase output of the tightly-coupled anode-to-grid transformer (usually having a Mumetal or ferrite core). When the valve starts to conduct,  $V_a$  falls and  $V_g$  is driven positive by the transformer action. A cumulative build-up of  $I_a$  and  $I_g$  to high values occurs, which causes  $V_a$  to drop sharply. The grid capacitor  $C$  is consequently charged by the large grid current and the tight transformer coupling ensures that the grid voltage is driven sufficiently far positive to permit this large current to flow.

The charge on  $C$  is now of such a value that it carries the grid well beyond the cut-off bias of the valve, thus stopping the flow of  $I_a$  and hence the production of the alternating grid voltage. The valve remains non-conducting while  $V_g$  rises exponentially towards earth potential with a time constant  $CR$  seconds. As soon as cut-off bias is reached,  $I_a$  flows again and the cycle repeats.

For correct operation a high negative bias voltage must be developed across  $C$  as there is a possibility of the positive-going excursion of the remaining, damped grid-voltage oscillation raising the grid above cut off again. To avoid this, damping (usually a parallel resistor) is sometimes added across the transformer. Choice of value of capacitor  $C$  is also influenced by the chance of ringing—if  $C$  is made

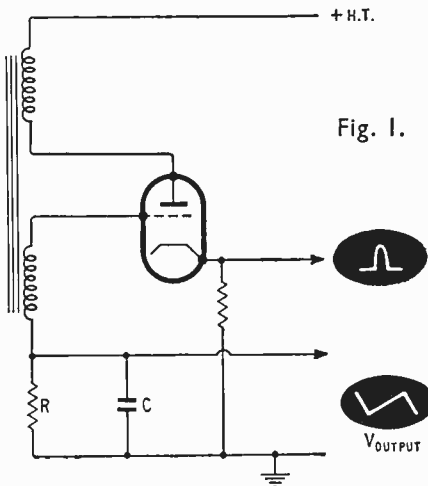

Fig. 1.

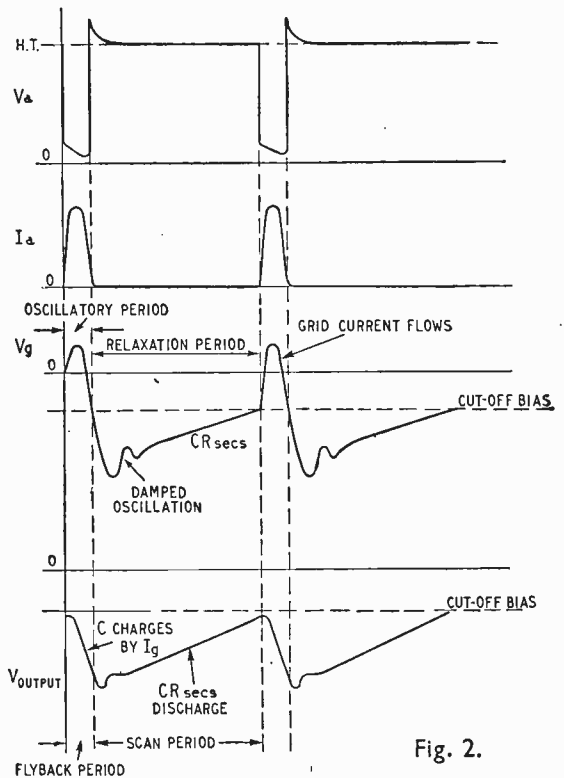

Fig. 2.

large it may not be charged sufficiently by grid current to ensure that the valve is held cut off after the half-cycle of oscillation. Thus for a slow p.r.f. a relatively small value is chosen for  $C$  with a correspondingly high value of  $R$ .

The timebase sawtooth waveform can be taken from  $C$  and, to make the rise in voltage more linear, grid-leak resistor  $R$  is sometimes connected to h.t. + instead of to earth. Positive-going pulses can be developed across the cathode resistor and applied to the c.r.t. cathode as blanking pulses, so blanking out the spot during the flyback period (i.e. the oscillatory period when  $I_a$  is flowing).

### TECHNICAL WRITING

IT is announced by the Technical Publications Association that nineteen colleges have registered as providing courses in technical authorship for the 1960/61 session. Details of the technical authorship syllabus and of the colleges providing courses are obtainable from the City and Guilds of London Institute, 76, Portland Place, London, W.1.

## CONFERENCES AND EXHIBITIONS

Latest information on events both in the U.K. and abroad during the next four months is given below. Further details are obtainable from the addresses in parentheses.

### LONDON

- Aug. 24-Sept. 3 **National Radio and Television Show** . . . . . Earls Court  
(Radio Industry Exhibitions Ltd., 59 Russell Square, London, W.C.1.)
- Sept. 1 **Rocket and Satellite Instrumentation** . . . . . 26 Portland Pl.  
(Society of Instrument Technology, 20 Queen Anne Street, London, W.1.)
- Nov. 21-25 **Industrial Photographic and TV Exhibition** . . . . . Albert Hall  
(Industrial and Trade Fairs Ltd., Drury House, Russell Street, London, W.C.2.)
- Nov. 22-24 **Electronic Telephone Exchanges (Conference)** . . . . . Savoy Place  
(I.E.E., Savoy Place, W.C.2.)
- Nov. 23-26 **Radio Hobbies Exhibition** . . . . . R.H.S. Old Hall  
(P. A. Thorogood, 35 Gibbs Green, Edgware, Middx.)
- Jan. 16-20 **Physical Society Exhibition** . . . . . R.H.S. Halls  
(Physical Society, 1 Lowther Gardens, S.W.7.)

### BOURNEMOUTH

- Oct. 18-19 **Air Traffic Control Convention** . . . . . Town Hall  
(Guild of Air Traffic Control Officers, 118 Mount Street, London, W.1.)

### CAMBRIDGE

- Sept. 15-17 **R.S.G.B. National Convention** . . . . . Arts School  
(H. Waton, 35 Metcalfe Road, Cambridge.)

### CARDIFF

- Aug. 31-Sept. 7 **British Association Annual Meeting**  
(British Association, 18 Adam Street, London, W.C.2.)

### CHELTENHAM

- Sept. 22-24 **Theory and Practice of Ultrasonic Inspection (Conference)** . . . . . Queens Hotel  
(I. M. Barnes, Materials Laboratory, de Havilland Propellers Ltd., Hatfield, Herts.)

### FARNBOROUGH

- Sept. 5-11 **Farnborough Air Show**  
(Society of British Aircraft Constructors, 29 King Street, London, S.W.1.)

### MANCHESTER

- Sept. 21-Oct. 1 **International Factory Equipment Exhibition** . . . . . Belle Vue  
(Industrial and Trade Fairs Ltd., Drury House, Russell Street, London, W.C.2.)

### OVERSEAS

- Aug. 29-Sept. 2 **Physics of Semiconductors Conference** . . . . . Prague  
(International Union of Pure and Applied Physics, 3 Boulevard Pasteur, Paris, 15.)
- Aug. 30-Sept. 6 **Firato—International Radio Show** . . . . . Amsterdam  
(Firato Secretariat, Emmalaan 20, Amsterdam, Z.)
- Sept. 14-15 **Military-Industrial Electronic Test Equipment Symposium** . . . . . Chicago  
(Armour Research Foundation, 10 West 35 St., Chicago.)
- Sept. 19-21 **Space Electronics and Telemetry** . . . . . Washington  
(I.R.E., 1 East 79 Street, New York.)
- Sept. 19-21 **International Symposium on Data Transmission** . . . . . Delft  
(B. Barrow, I.R.E., Postbus 174, The Hague.)
- Sept. 21-22 **Industrial Electronics Symposium** . . . . . Cleveland  
(I.R.E., 1 East 79 Street, New York.)
- Oct. 3-5 **Communications Symposium** . . . . . Utica  
(I.R.E., 1 East 79 Street, New York.)
- Oct. 4-6 **Radio Interference Reduction (Conference)** . . . . . Chicago  
(Armour Research Foundation, 10 West 35 St., Chicago.)
- Oct. 10-12 **National Electronics Conference** . . . . . Chicago  
(I.R.E., 1 East 79 Street, New York.)
- Oct. 19-26 **Interkama—Congress and Exhibition for Instrumentation and Automation** . . . . . Dusseldorf  
(Nordwestdeutsche Ausstellungen, Ehrenhof 4, Dusseldorf.)
- Oct. 24-26 **Aeronautical and Navigational Electronics (Conference)** . . . . . Baltimore  
(I.R.E., 1 East 79 Street, New York.)
- Nov. 14-16 **Mid-American Electronics Convention** . . . . . Kansas City  
(L. R. Crissman, T.W.A., 10, Richards Rd., Kansas City.)
- Nov. 14-17 **Magnetism and Magnetic Materials (Conference)** . . . . . New York  
(L. R. Bickford, I.B.M. Research Center, Yorktown Heights, N.Y.)
- Nov. 15-17 **Electronics Research and Engineering Meeting** . . . . . Boston  
(I.R.E., 73 Tremont Street, Boston, Mass.)
- Dec. 13-15 **Eastern Joint Computer Conference** . . . . . New York  
(P.O. Box 2580, Grand Central Station, New York, 17.)
- Jan. 9-11 **Reliability and Quality Control Symposium** . . . . . Philadelphia  
(R. Brewer, G.E.C. Research Labs., Wembley, Middx.)



Two  
New

Additions to the  
**TRIX Sound**  
Equipment range



### Model B100

Transistorised Amplifier for 12 volt operation. Output 12 watts. Inputs for microphone and music. Minimum battery consumption—maximum efficiency.

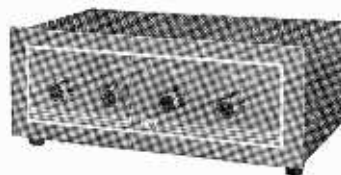

### Model GP100

AC operated general purpose high quality Amplifier. 4-way Input Selector—Bass and Treble controls. 10/12 watts output.

Full details available  
on request.

**TRIX**

THE TRIX ELECTRICAL CO. LTD.  
1-5 MAPLE PLACE, LONDON, W.1

Tel.: Museum 5517 (8 lines)  
Grams: Trixadio Wesdo London

# RANDOM RADIATIONS

By "DIALLIST"

## The "Dip. Tech."

FROM facts and figures issued by the National Council for Technological Awards one gathers that the Dip. Tech. has not only made a most promising start but has come to stay. The qualification, equal in standing to an honours degree at a university, has already been awarded to 163 students, including one woman. There are now 95 recognized courses at 23 technical colleges and nearly 4,000 students, including 84 women, have been enrolled. The demand for men and women with science qualifications is ever increasing and the universities are already so packed that there can't be room for all who would like to become students. And there's more to it than that. As its name implies, a university should deal with all branches of human knowledge. It must not specialize or it ceases to be a university, nor must it allow any faculty to become so big that it overshadows the rest. Hence it would never do to allot vacancies to all those who wish to obtain scientific qualifications. To do so would mean upsetting the balance. The Dip. Tech. provides a very satisfactory answer to the problem of coping with a far greater number of would-be science and technology students than the universities can cater for.

## TV/DX in Bermuda

FROM Pembroke in Bermuda a reader writes to tell me of his experiences of long-distance TV reception. He is service manager of a firm and it occurred to him that it would be very useful if he could obtain a good picture in the showrooms at times when the local station, on Channel 10, wasn't working. He put up a 5-element aerial covering the American Channels 2-13 on a 20-foot mast on the roof of the 45-foot high building. The result was just astonishing. Havana, in Cuba, though 1,000 miles away, comes in steadily and regularly with very little background snowiness. Other distant stations giving pictures with real entertainment value are Daytona Beach in Florida on Channel 2 and Washington, D.C., on Channel 3. A glance at an atlas will show you that these are quite remarkable feats. His concluding sentence is of particular

interest: "The British receiver which my firm stocks always gives a better contrasted and more snow-free picture than the most expensive American sets of any make, even those claimed to be in the luxury class."

## Telesmellevison ?

IN the U.S.A. several cine theatres are now equipped with apparatus which releases appropriate odours at the right moments. In jungle scenes, for instance, there might come whiffs of lion, tiger or elephant, or a garden scene can be accompanied by the scent of roses. The idea seems to have caught on, for a good few other theatres are ordering the apparatus. The gear has not yet reached a form suitable for domestic use but it could be developed to meet the requirements of a theatre showing big-screen television. Television has shown that it can do most if not all of the things so far achieved by the cinema. So why not? How does it work? A revolving platform carries bottles charged with the required scents, and capable of dispensing the scent in aerosol form. A foil strip pasted to the film switches on a device which brings the required bottle into position and then causes a plunger to press the knob. The scent is diffused *via* the air conditioning system and is said to be mopped up electrostatically when it ceases to be re-

quired. For telesmellevison the transmission of special trains of pulses would be needed, of course.

## Pulse Pacemaker

WHEN Galvani made the leg of a dead frog twitch by connecting the muscles to an electric cell it is extremely unlikely that he had any idea that he had made a discovery which long after his death would lead doctors to developing methods of dealing with conditions in the human body which had hitherto been regarded as incurable. Yet this has happened, for doctors in Britain, Sweden and the U.S.A. are now using electric pulses to regulate heart beats. You couldn't very well run wires leading to the heart from a battery, but you *can* use the transformer principle, with the secondary, buried in the body and the primary outside it. As I wrote some time ago in these notes, the induction principle was used by a French doctor in an attempt to make a totally deaf person hear. What is being done in the case of irregular hearts is to implant a small secondary coil into the body and to connect it to the main nervous system of the heart. Outside the body is a time-base connected to the primary. By means of this, sync pulses are applied to the heart, which responds to them and begins to beat regularly. It is reported that when the device has been



## "WIRELESS WORLD" PUBLICATIONS

	Net Price	By Post
<b>CORRECTING TELEVISION PICTURE FAULTS.</b> John Cura and Leonard Stanley	4/-	4/6
<b>ELECTRONIC COMPUTERS: Principles and Applications.</b> T. E. Ivall. 2nd Edition	25/-	26/-
<b>TELEVISION RECEIVING EQUIPMENT.</b> W. T. Cocking, M.I.E.E. 4th Edition	30/-	31/9
<b>TRANSISTOR A.F. AMPLIFIERS.</b> D. D. Jones, M.Sc., D.I.C., and R. A. Hilbourne, B.Sc.	21/-	21/10
<b>INTRODUCTION TO LAPLACE TRANSFORMS for radio and electronic engineers.</b> W. D. Day, Grad.I.E.E., A.M.Brit.I.R.E.	32/6	33/6
<b>MICROWAVE DATA TABLES.</b> A. E. Booth, M.I.R.E., Graduate I.E.E.	27/6	28/8
<b>PRINCIPLES OF FREQUENCY MODULATION.</b> B. S. Camies	21/-	21/10
<b>SECOND THOUGHTS ON RADIO THEORY.</b> Cathode Ray of "Wireless World"	25/-	26/4

A complete list of books is available on application.  
Obtainable from all leading booksellers or from

LIFFE & SONS LTD., Dorset House Stamford Street, London, S.E.1



in use for some time the heart may become so trained that it continues to beat as it should when the pulses are switched off for a while.

### *Bigger and Bigger Screens*

IN most countries which have television services there's a marked movement towards larger c.r. tubes for receivers. In France 19-, 21- and 23-in tubes have been popular for a year or two now. That's understandable, for even with such large screens an 819-line image is not liney, even if sets are used in quite small rooms. One rather wonders, though, whether the 19- and 23-in screens which are expected to be the standard size in the U.S.A. this year will be successful with 525-line images. Still the radio industry over there is predicting that the bigger (and let's hope better) sets will sell like hot cakes. So far I haven't seen a 625-line picture on a 19-in screen, but it's pretty well bound to be liny at closish quarters. There is, I fancy, bedrock truth in the suggestion made in a recent *Wireless World* editorial that many viewers don't mind liness. At any rate no British receiver using spot-wobble or spot-astigmatism has succeeded in catching on. Whenever I've seen spot-wobble sets in use in people's homes the wobble switch has always been in the off position.

### *Still Going Up*

WITH 55,193 new combined TV/sound licences taken out in June, the total at the end of the month was 10,702,131. The summer months aren't normally responsible for big increases, though this year the cold, wet weather may be making people think more of indoor rather than of outdoor diversities. Anyhow, as the combined total of television and sound-only licences had reached 15,104,329 at the end of June there can't be an enormous number of homes now where there isn't a set of one kind or another, or sets of both kinds. Still, we're a good way yet from reaching saturation, in TV at any rate. With nearly four and a half million homes with nothing but sound only receivers there's still a bigish slice of our population to be roped into the television fold. New stations, both B.B.C. and I.T.A., are going up and satellites and boosters will be coming into action in more and more of the difficult areas. Every such station is bound to keep things moving and in some places where good pictures have seldom been obtainable the increased number of viewers should be considerable.

# THE BULGIN BULLETIN

Electronic Engineers the world over, take the opportunity of receiving month by month our fully illustrated Electronic Component Bulletin. Produced with Industry in mind, it deals with the latest developments and additions to the extensive range of Electronic Components manufactured by the House of Bulgin. If you wish your name to be included on our mailing list for future issues of this publication, write to-day attaching **trade or professional letterhead** to the address shown below.

## CATALOGUE

The House of Bulgin is pleased to announce the publication of a new 1960 Catalogue containing full working details and dimensions of

### OVER 10,000 ELECTRONIC COMPONENTS

Send for catalogue 201/C. Price 2/6d. post free, or free to trade letterhead or order.

★ **WRITE**      ↓      **NOW** ★

A. F. BULGIN & CO., LTD. · BYE-PASS RD., BARKING, ESSEX.

TELEPHONE: RIP 5588 (12 lines)

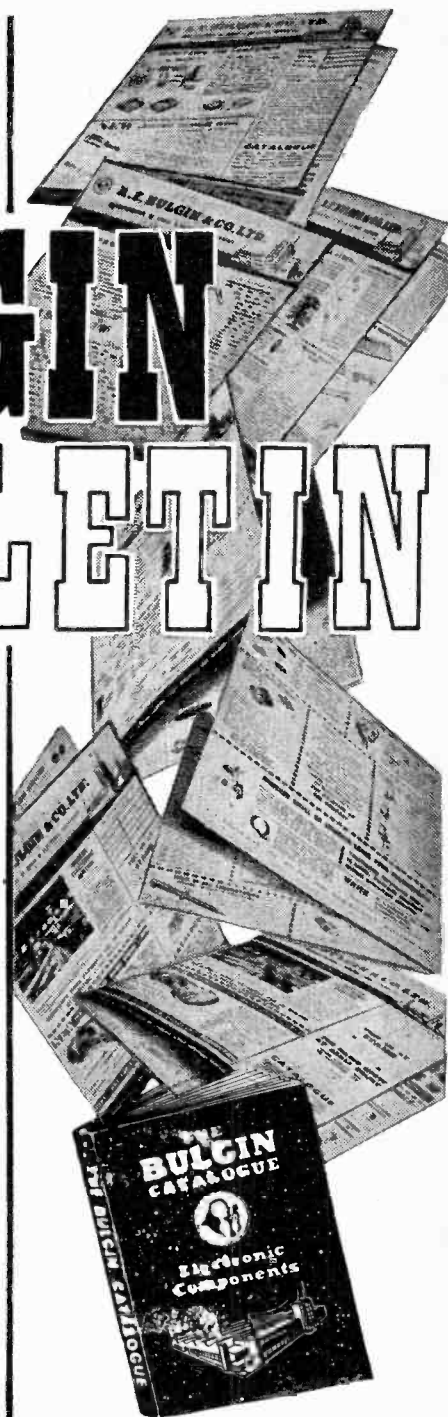

## "Line upon Line"

AS these notes are intended for the September issue, it means that it is just thirty years since I started writing in these columns by prophesying that the then largely discredited superhet showed unmistakable signs of staging a comeback (September 17th, 1930). It was then considered that good quality and the superheterodyne principle would never run together in harness. But that attitude has long since been forgotten.

Nowadays, judging by the Editor's remarks in the July issue, the question is whether a good-quality picture—or at any rate a reasonably non-liney one—can be obtained with 405-line television.

I certainly received a salutary shock when I first read in the July issue the Editor's stringent strictures on the popular idea that everything in the garden would be lovely if we changed our TV system from 405 to 625 lines. Hitherto I have not given any very serious thought to the matter but in my ignorance have just followed the herd-minded belief that the only remedy for "lines" was to have more of them.

The Editor rightly tells us there are ways of getting rid of lines other than by increasing their number, and one method which he picks out for mention is "spot wobble." At the risk of being impeached for lese-majesty I feel I must disagree, as spot-wobble to my mind is rather like the dodge of the old-time photographer who used to use what



Mrs. Free Grid also has views on lines.

he called a soft-focus lens to blur the blemishes and iron out the hard lines on the faces of some of his fair sitters who were no longer as young as they wished to appear in the photograph. Like Oliver Cromwell I prefer my picture "warts and all."

To my mind the real cause of the totally unnecessary lininess one sees on some TV screens is simply that the set is not interlacing correctly.

After all, if the odd-numbered lines do not fall squarely between the even-numbered ones, they tend to merge with them and so produce a coarse thick-lines and wide-spaces effect. I'm afraid many viewers don't know that incorrect interlacing can occur and so they wrongly blame the 405-line system.

## 1910 and All That

AS I sat listening to the "Scrapbook for 1910" some time ago, I could not help thinking what a wonderful year it must have been to have lived through. Life seemed to be one long round of music, dancing and theatre-going, with no clouds of war and no nuclear nightmares; and only the rollicking fun of the militant suffragettes to cause anxiety to the Government.

As I sighed and remarked on this to Mrs. Free Grid, she, with the uncompromising reason of her sex, tartly reminded me that I *had* lived through the year 1910. So indeed I had, but I suppose my memory is not what it was, otherwise I should have recognized the joyful scene.

My one criticism of the programme, however, is of a technical nature. Naturally we were regaled with the oft-told story of Dr. Crippen. We were given a touch of realism by being permitted to hear the actual message from Captain Kendall of the *Montrose* to Scotland Yard, being growled out by the ship's radio operator.

As I rather fancy myself as a morse reader, I naturally seized pencil and paper to take down the message. But I must confess I could make neither head nor tail of it. It seemed just a jumble of gibberish. Surely the radio operator of the *Montrose*, if he is still alive, could obtain substantial damages for libel, slander, defamation of professional ability and half a dozen other things?

Yet the Post Office radio operator at Land's End must have understood the message as its receipt at Scotland Yard sent Inspector Dew scurrying across the Atlantic in the *Laurentic* to overtake the *Montrose*. Could it be that the jumble of sound was sent by somebody who knew nothing of morse? Surely the B.B.C. could have borrowed a radio operator from somewhere or even invited the services of a competent amateur. As it was, the producer's attempt at realism turned to ashes in my mouth, or should I say the sounding of brass and the tinkling of cymbals in my ears.

There is another small point of criticism, which is also a technical

one but chronometrical rather than radio. It is simply that the producer did not seem familiar with the correct method of measuring the passing years. 1910 was *not* the first year of a new decade as was stated. One thing more. If, as I believe, we are to hear a scrapbook for 1911, I hope *Wireless World's* birthday in that year will not be forgotten.

## Out of Synchrony

WE are often told that science is measurement, and this view was certainly confirmed in my mind when I heard of a molecular clock which does not lose or gain one second in a century. Actually I read about this in *IEA News*, a publication issued at the time of the I.E.A. exhibition by its organizers to tell us all about the wonders to be seen there.

But turning to another page of the same publication, my faith in science measurement was rudely shattered when I found that the Editor (or one of his slaves) makes it very plain that 1960 is regarded as the first year of a new decade. This sort of muddled thinking is what one might expect in lay circles, but is hardly in keeping with the split-second and split-micron accuracy that pervades the other pages of the I.E.A. publication.

In theory the present era began on January 1st in the year A.D. 1. Not until ten years had passed could our ancestors have legitimately hailed the beginning of the second decade on 1st January, A.D. 11, and it was not until six complete decades had passed that they could on 1st January, A.D. 61 hail the birth of the seventh decade. Similarly, we of the present century must wait until it has completed six decades before we start our own seventh one on 1st January, 1961.

It is true the "sixties" and the seventh decade are nearly but not quite in synchrony; just 10% out. But in scientific matters "nearly" or "10%" is not good enough; it would be useless, for instance, for an ordinary electric clock to be nearly but not quite in step with the supply mains.

Of course, I may be quite wrong in my view. It could be it is myself who is out of step, or, in other words, not quite in synchrony. If so, I hope somebody will take on the rôle of sergeant-major and devastate me with a blast of invective as so frequently happened in the days of the first world war when my faltering footsteps were so often nearly but not quite in synchrony with those of the rest of the platoon.